

GEL CONNECTION

SMALL WATERPROOF ACCESSORIES FOR BIG INSTALLATIONS

IPX8
OFFICIALLY
TESTED | **IMQ**



**Ray
tech**[®]

CABLE ACCESSORIES COMPANY



Ray Tech®

CABLE ACCESSORIES COMPANY

Revolution

pag. 4

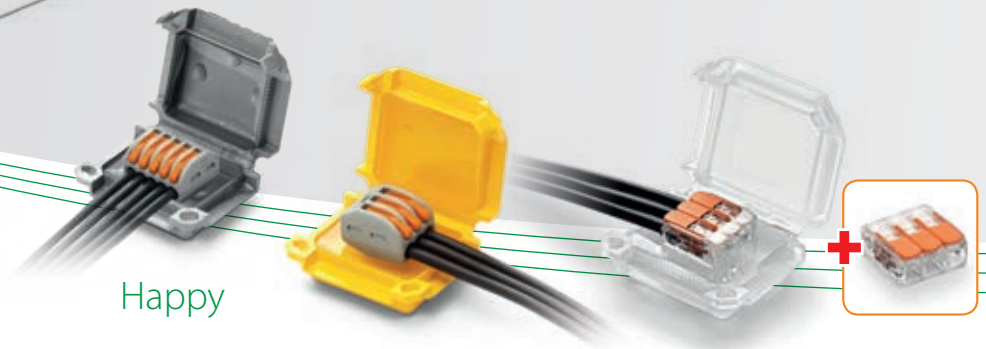

Happy

Happy Joint

Classic Gel Box Line

pag. 8

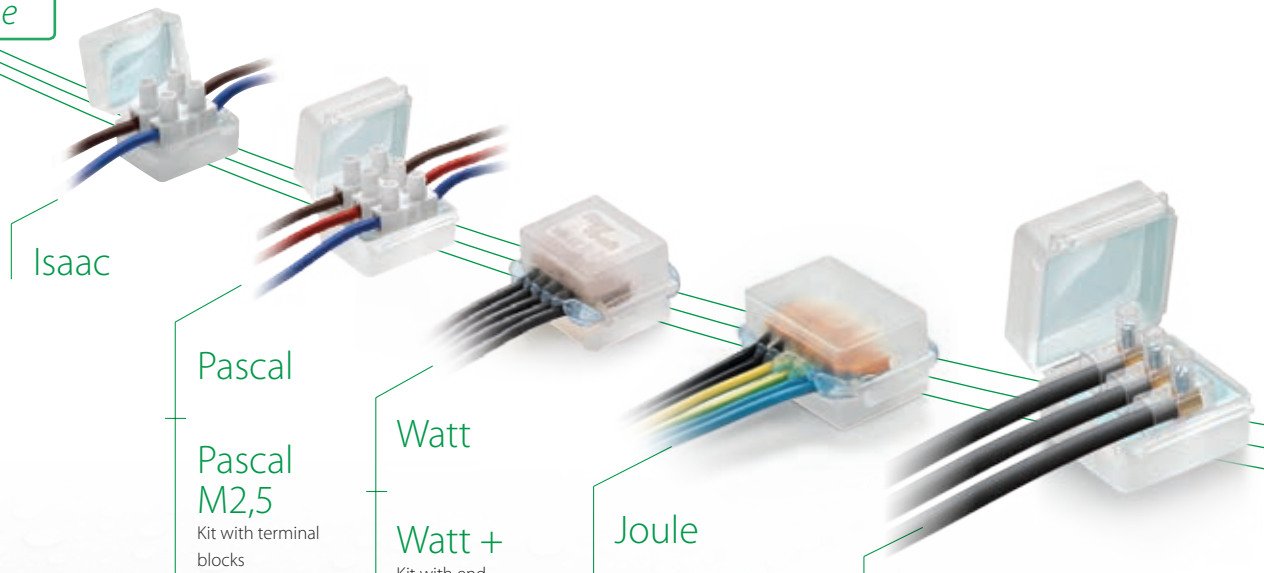

Isaac

Pascal

Pascal M2,5
Kit with terminal blocks

Watt

Watt +
Kit with end connectors/terminal blocks

Joule

Kelvin

Kelvin +
Kit with end connectors/terminal blocks

Kelvin M4
Kit with terminal blocks

IPX8
OFFICIALLY
TESTED

IMQ

GEL CONNECTION

SMALL **WATERPROOF** ACCESSORIES FOR BIG INSTALLATIONS

THE STRENGTH OF SIMPLICITY, the largest range of small pre-filled accessories to protect, make reliable and seal electrical connections.

Ready to use and with no shelf life, they offer maximum versatility through the widest variety of dimensions to face any installation with efficiency and comfort.

Suitable for several types of connectors, from traditional screwed strip connectors to the latest innovative extra flat models. They represent the most versatile, easy to use and reliable system to bring connectors designed for indoors, outdoors.

Classic

Gel Cover Line

pag. 12

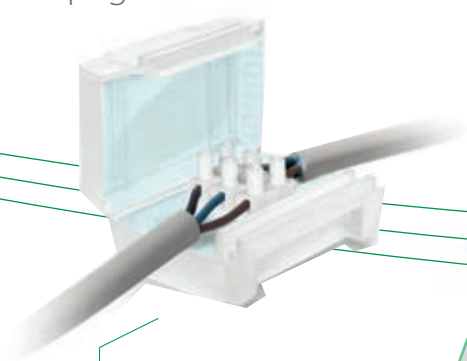

OHM & BAR



Mammut gel cover

Special Kit

pag. 14



Nano Joint

Extra flat connectors



Nano For

Kit with end connectors/
terminal blocks



Nano Mam

Kit with terminal blocks

Bravo
with integrated connectors



Happy

The revolutionary mini accessories with 3 entrances, pre-filled with gel and suitable for submersible installations (IPX8).

Gel: UL 94-HB

Operating temperature

Installation temperature:
-40°C / +50°C

Fully submersible

Can be used underground

IPX8
OFFICIALLY
TESTED **IMQ**

Designed in 3 dimensions to rapidly insulate and seal the most commonly used connectors. The 3 entrances not only guarantee the extreme flexibility in the range of these products but also by the housing accepting a wide variety of connectors.

- Extremely versatile - Ready to use - Re-enterable
- For rigid or flexible insulated wires up to 4 mm²
- Pre-filled with gel, non toxic and no shelf life
- Small compact and robust
- Halogen free
- UV resistant

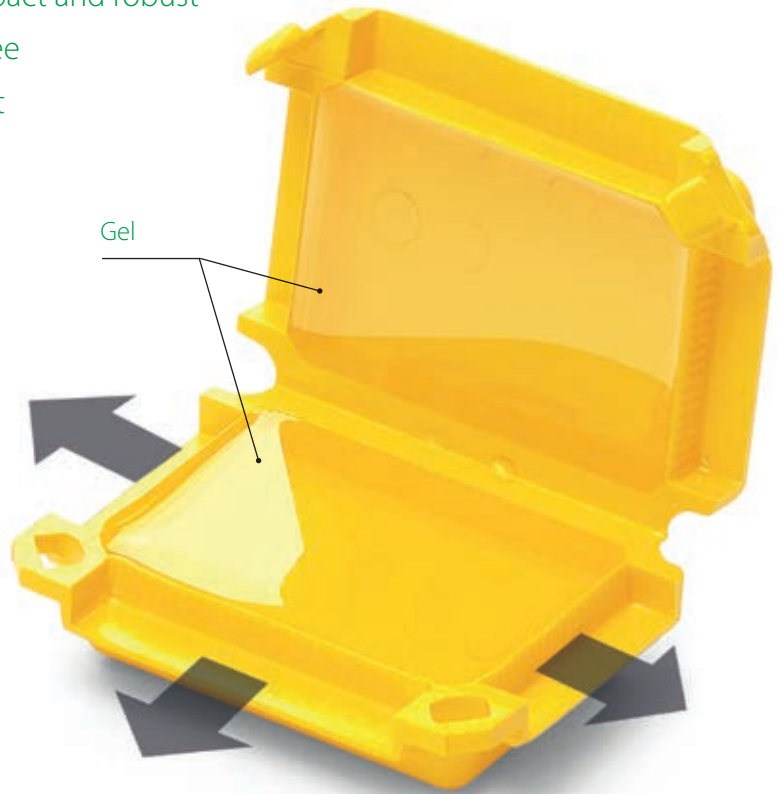
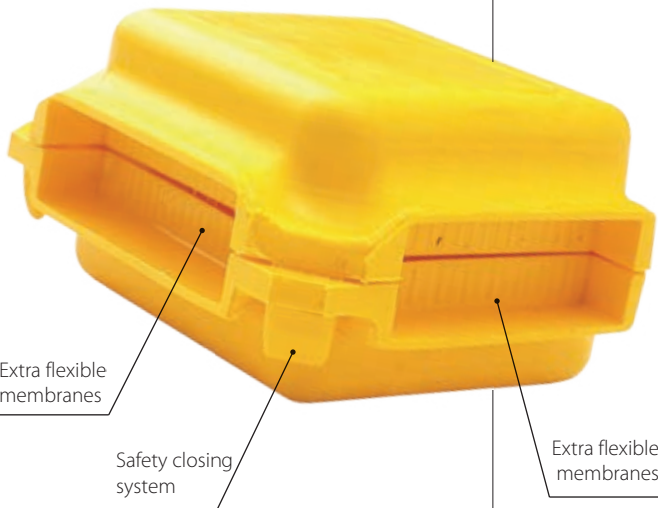

Configuration examples

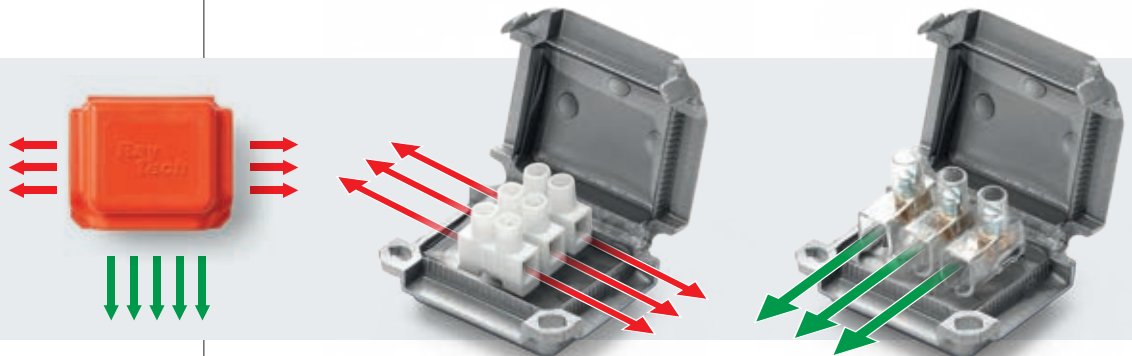



Happy 0

Product	Description	Package	A x B x C (mm)
Happy 0	x 4 pcs	Blister	41 x 28 x 19



IDEAL FOR (or similar):

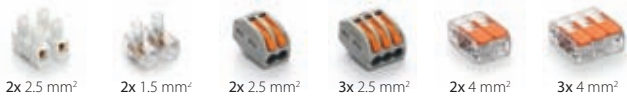

Happy 1

Product	Description	Package	A x B x C (mm)
Happy 1	x 2 pcs	Blister	45 x 37 x 24



IDEAL FOR (or similar):



Happy 2

Product	Description	Package	A x B x C (mm)
Happy 1	x 1 pcs	Blister	53 x 39 x 24



IDEAL FOR (or similar):

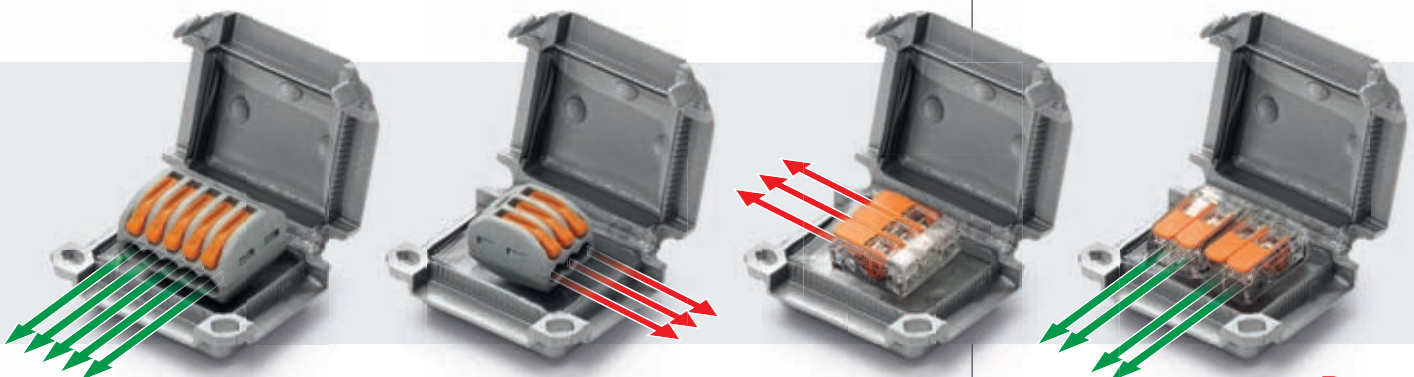
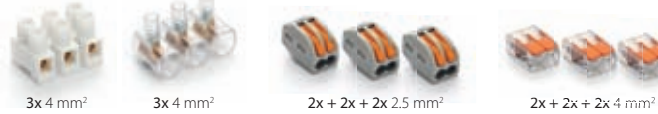



Electrical performance:
CEI EN 50393: 2006
as applicable

Gel: UL 94-HB

Operating temperature

Installation temperature:
-40°C / +50°C

Fully submersible

Can be used underground

IPX8
OFFICIALLY
TESTED | **IMQ**

Happy Joint

The revolutionary mini accessories with 3 entrances, pre-filled with gel and suitable for submersible installations (IPX8) complete with connectors.

- Extremely versatile - ready to use - re-enterable
- Small, compact and robust
- No need for tools
- Pre-filled with gel, non toxic and no shelf life
- Can energise immediately
- For straight and branch connections
- For rigid or flexible insulated wires up to 4 mm²
- Up to 5 conductors on one phase or up to two conductors on two or three phases
- Halogen free
- UV resistant

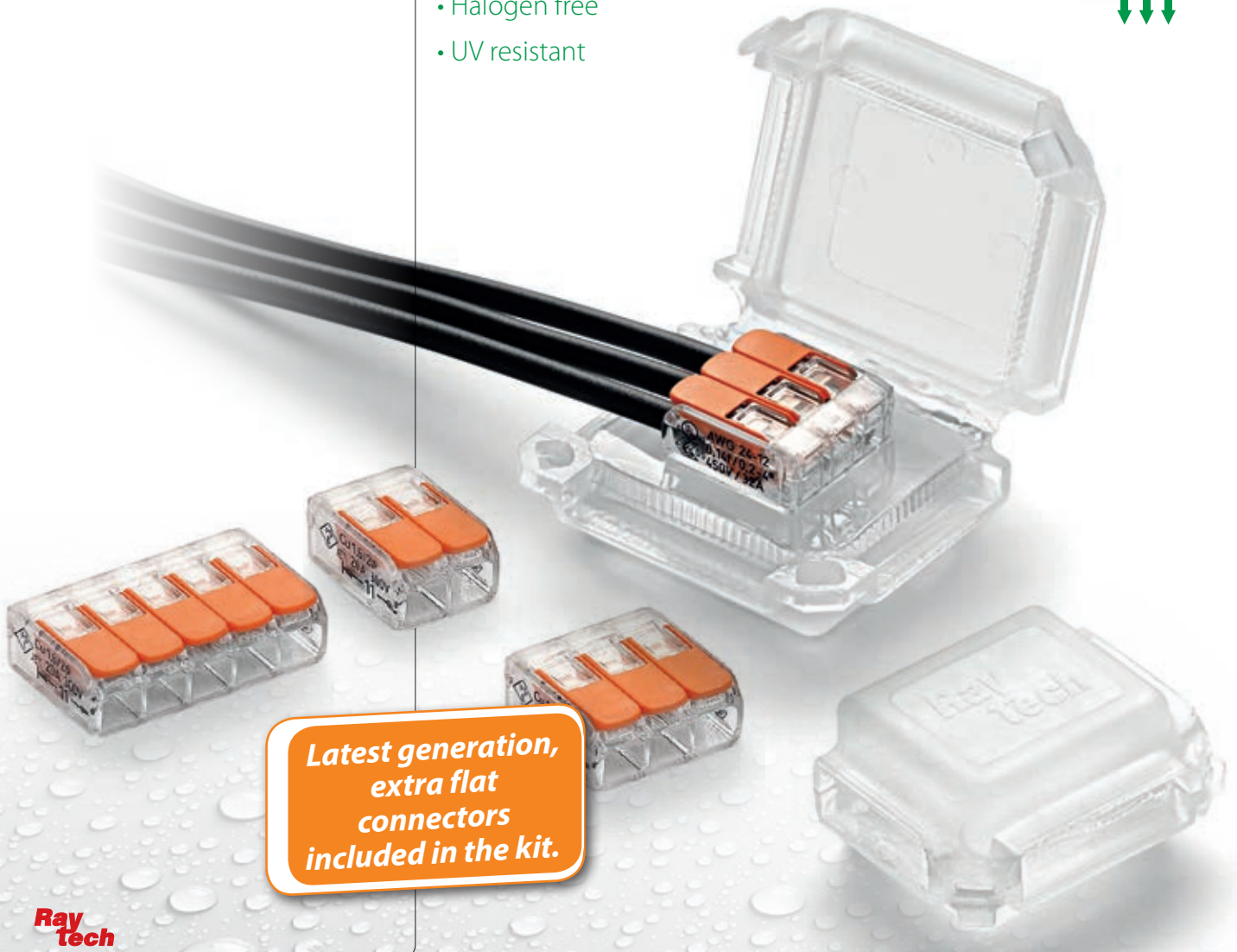

*Latest generation,
extra flat
connectors
included in the kit.*



Happy Joint 3

Product	Formation and wires cross section (Max N° x mm ²)	Combination	Pieces for package	A x B x C (mm)
Happy Joint 3	3 x 1 - 4	2 through / 1 branch	4 pcs/ Blister	41 x 28 x 19



With one connector included for each Happy

Happy Joint 4

Product	Formation and wires cross section (Max N° x mm ²)	Combination	Pieces for package	A x B x C (mm)
Happy Joint 4	4 x 1 - 4	2 through / in/out	2 pcs/ Blister	45 x 37 x 24



With two connectors included for each Happy

Happy Joint 5

Product	Formation and wires cross section (Max N° x mm ²)	Combination	Pieces for package	A x B x C (mm)
Happy Joint 5	5 x 1 - 4	2 through / 3 branch	2 pcs/ Blister	45 x 37 x 24



With one connector included for each Happy

Happy Joint 6

Product	Formation and wires cross section (Max N° x mm ²)	Combination	Pieces for package	A x B x C (mm)
Happy Joint 6	6 x 1 - 4	3 through / in/out	1 pcs/ Blister	53 x 39 x 24



With three connectors included for each Happy

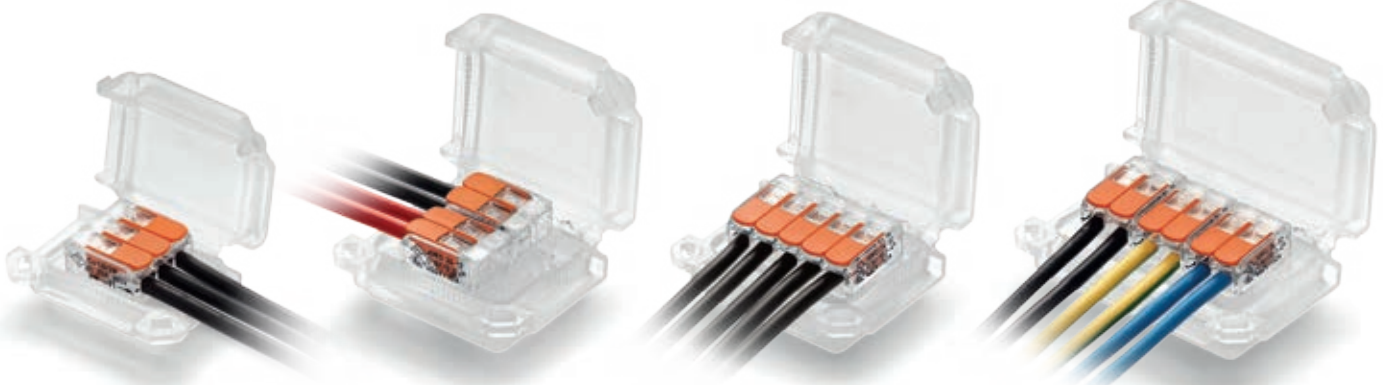

HAPPY JOINT 3

HAPPY JOINT 4

HAPPY JOINT 5

HAPPY JOINT 6



Gel: UL 94-HB 

Operating temperature 

Installation temperature: -40°C / +50°C 

Fully submersible 

Can be used underground 

IPX8
OFFICIALLY TESTED 

GEL BOX LINE
*a simple way
to bring indoor
connectors outdoors*

Gel Box Line

Pre-filled gel accessories for sealing, protecting and making safe electrical connections

- To put household systems in order
- For civil and industrial connections
- Also for submersible use
- Non-toxic and with no shelf life
- Versatile and ready to use
- Designed with dimensions suitable for the most commonly used connectors

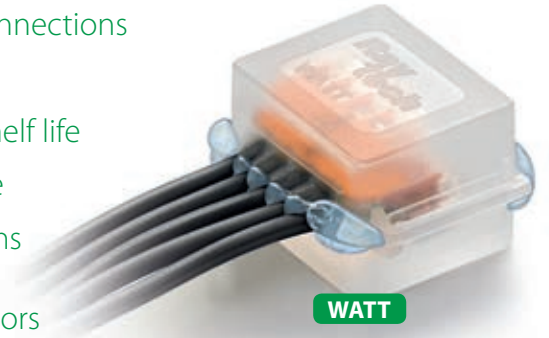



JOULE

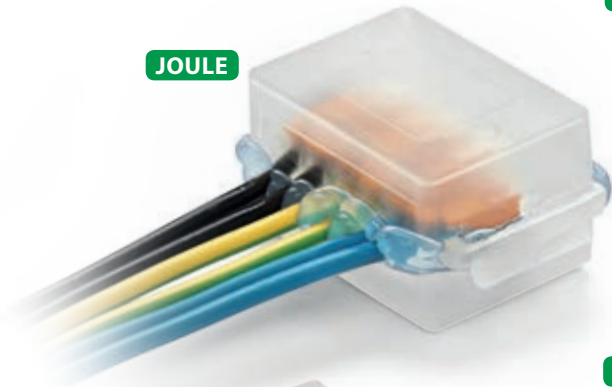

ISAAC



KELVIN

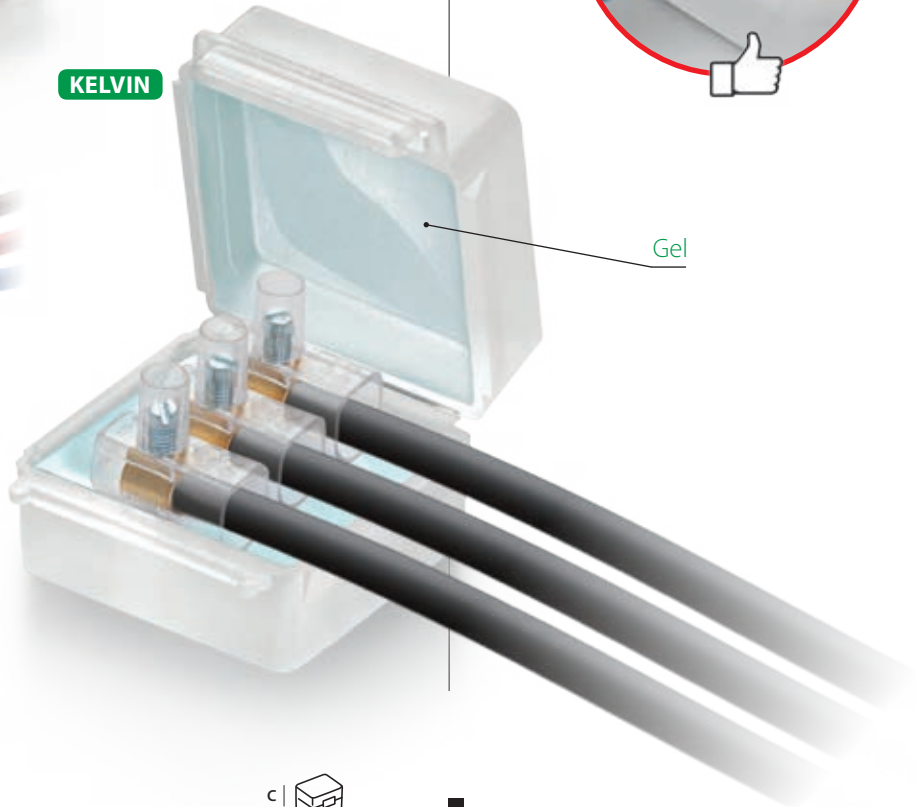

PASCAL



Gel

Isaac



Product	Description	Package	A x B x C (mm)
Isaac 4	x 4 pcs	Blister	
Isaac 4 P30	x 30 pcs	Box	30 x 27 x 23
Isaac 4 MP *	x 50 pcs	Multipack	

IDEAL FOR (or similar):



2x 2.5 mm²

2x 2.5 mm²

3x 2.5 mm²

2x 4 mm²

3x 4 mm²

* Also available the flame retardant version in the following colours: yellow, orange, blue or black.



Pascal



Product	Description	Package	A x B x C (mm)
Pascal 6	x 2 pcs	Blister	
Pascal 6 P15	x 15 pcs	Box	36 x 37 x 26
Pascal 6 MP *	x 25 pcs	Multipack	

IDEAL FOR (or similar):



2x 4 mm²

3x 4 mm²

3x 1.5 mm²

2x + 2x 2.5 mm²

5x 2.5 mm²

* Also available the flame retardant version in the following colours: yellow, orange, blue or black.





Watt



Product	Description	Package	A x B x C (mm)
Watt	x 2 pcs	Blister	
Watt P15	x 15 pcs	Box	30 x 42 x 26
Watt MP *	x 25 pcs	Multipack	

IDEAL FOR (or similar):



3x 2.5 mm²



2x + 2x 2.5 mm²



5x 2.5 mm²



2x + 2x 4 mm²



5x 4 mm²

* Also available the flame retardant version in the following colours: yellow, orange, blue or black.



Joule

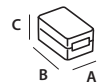

Product	Description	Package	A x B x C (mm)
Joule	x 1 pcs	Blister	
Joule MP *	x 20 pcs	Multipack	33 x 52 x 26

IDEAL FOR (or similar):



2x + 2x + 2x 2.5 mm²



2x + 2x + 2x 4 mm²

* Also available the flame retardant version in the following colours: yellow, orange, blue or black.



Kelvin



Product	Description	Package	A x B x C (mm)
Kelvin	x 1 pcs	Blister	
Kelvin P9	x 9 pcs	Box	52 x 53 x 29
Kelvin MP *	x 20 pcs	Multipack	

IDEAL FOR (or similar):



3x 6 mm²



3x 6 mm²

* Also available the flame retardant version in the following colours: yellow, orange, blue or black.

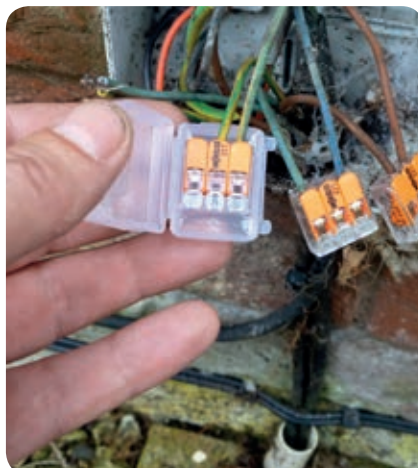



Gel Box Line Kit

Complete with connectors

Pascal M2,5

Product	Description	Package	A x B x C (mm)
Pascal M2,5	12 pieces + 36 terminal blocks (2.5 mm ²)	Box	36 x 37 x 26



Kelvin M4

Product	Description	Package	A x B x C (mm)
Kelvin M4	6 pieces + 24 terminal blocks (4 mm ²)	Box	52 x 53 x 29

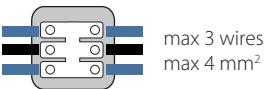

Watt +

Product	Description	Package	A x B x C (mm)
Watt + 1.5	10 pieces + 30 end connectors/terminal blocks (1.5 mm ²)	Box	30 x 42 x 26
Watt + 2.5	10 pieces + 30 end connectors/terminal blocks (2.5 mm ²)	Box	

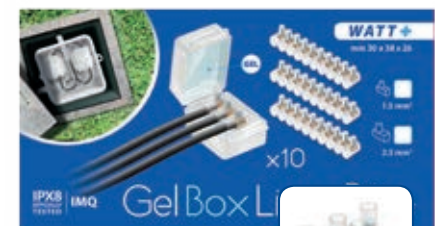
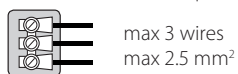

Kelvin +

Product	Description	Package	A x B x C (mm)
Kelvin + 4	10 pieces + 30 end connectors/terminal blocks (4 mm ²)	Box	52 x 53 x 29
Kelvin + 6	10 pieces + 30 end connectors/terminal blocks (6 mm ²)	Box	
Kelvin 6+4	6 pieces + 20 end connectors/terminal blocks (4 mm ²)	Box	
Kelvin 6+6	6 pieces + 20 end connectors/terminal blocks (6 mm ²)	Box	



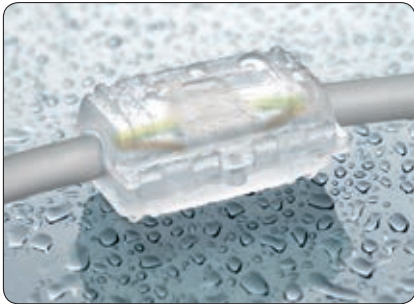

Electrical performance: CEI EN 50393

Gel: UL 94-HB

Operating temperature

Installation temperature: -40°C / +50°C

IPX8 OFFICIALLY TESTED | IMQ

Gel Cover Line

Pre-filled gel accessories for straight connections, for the protection, safety and covering of electrical connections using strip connectors or alternatives

- For 3 x 1 to 6 mm² cables or 3 insulated wires
- For civil and industrial connections
- To put household systems in order
- Also for underwater use
- Non-toxic and with no shelf life
- Ready to use

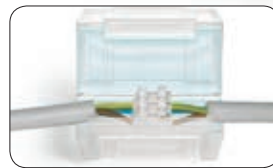
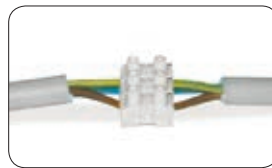
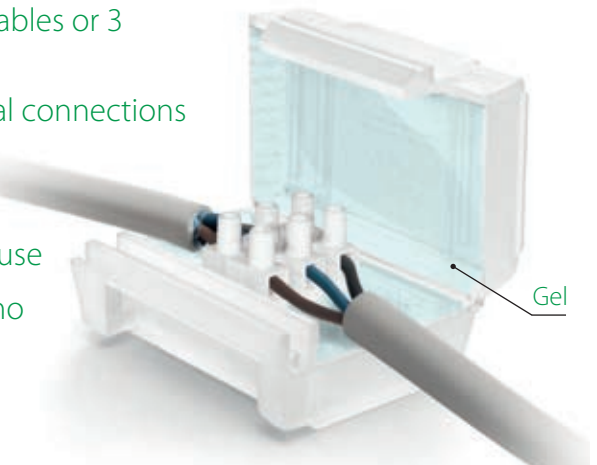

OHM & BAR

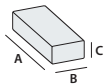

Product	Housed connectors type	Pieces for package	Package type	Dimensions A x B x C (mm)
OHM	2 from 4 mm ²	1	blister	61 x 35 x 28
OHMp11		11	box	
BAR	3 from 4 mm ² / 6 mm ²	1	blister	63 x 41 x 28
BARp9		9	box	



Mammut Gel Cover

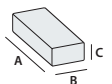

Product	Housed connectors type	Pieces for package	Package type	Dimensions A x B x C (mm)
Gel Cover 4	2 from 4 mm ²	1	blister	61 x 35 x 28
Mammut Gel Cover		6	box	
Gel Cover 6	3 from 4 mm ² / 6 mm ²	1	blister	63 x 41 x 28
Mammut Gel Cover 6		8	box	

No flame propagation. CEI 20-35 • IEC 60332-1 • HD405-1 (as applicable) **Casing mix:** UL 94-V2

Installation examples

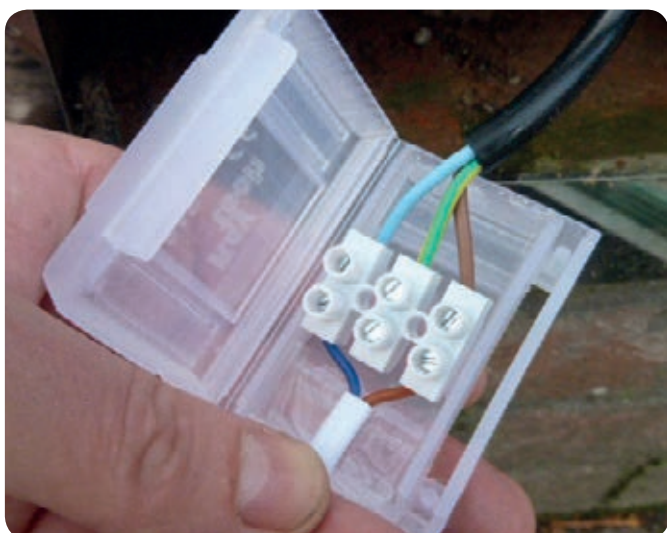



Nano Joint

Electrical performance:

CEI EN 50393: 2006
as applicable

Gel: UL 94-HB 

Operating temperature 

Installation temperature: 
-40°C / +50°C

Fully submersible 

Can be used underground 

IPX8
OFFICIALLY
TESTED | **IMQ**

Pre-filled gel accessories to seal, protect and make safe electrical connections.

Inclusive of connectors

- Ready to use, quick, re-enterable!
- No tools required
- Can energise immediately
- For straight & branch connections
- For rigid or flexible insulated wires from 1 a 4 mm²
- For 1, 2 and 3 cores connections
- Up to 5 conductors on one phase or up to 2 conductors on two or three phase
- Small, compact and resistant
- No shelf life
- Halogen free
- UV resistant



NANO JOINT 3

NANO JOINT 5

NANO JOINT 6

*Latest generation,
extra flat connectors
included in thew kit.*



Nano 3

Product	Formation and wires cross section (Max N° x mm ²)	Combination	Pieces for package	A x B x C (mm)
Nano 3	3 x 1 - 4	2 through / 1 branch	4 pcs/ Blister	30 x 27 x 23



With one connector included for each Nano Joint



Nano 5

Product	Formation and wires cross section (Max N° x mm ²)	Combination	Pieces for package	A x B x C (mm)
Nano 5	5 x 1 - 4	2 through / 3 branch	2 pcs/ Blister	30 x 42 x 26



With one connector included for each Nano Joint



Nano 6

Product	Formation and wires cross section (Max N° x mm ²)	Combination	Pieces for package	A x B x C (mm)
Nano 6	6 x 1 - 4	3 through / In/Out	1 pcs/ Blister	33 x 52 x 26



With three connectors included for each Nano Joint





Nano Mam - For

Electrical performance:

CEI EN 50393: 2006
as applicable

Gel: UL 94-HB

Operating temperature

Installation temperature:
-40°C / +50°C

Fully submersible

Can be used underground

IPX8
OFFICIALLY
TESTED

IMQ

Pre-filled gel accessories to seal, protect and make safe electrical connections.
Inclusive of connectors.

- Ready to use, quick, re-enterable!
- Ideal for outdoor & underground installations, fully submersible
- Immediately energizable
- For rigid or flexible insulated wires from 1 a 4 mm²
- For 1, 2 or 3 cores connections
- Small, compact and resistant
- No shelf life
- Halogen free
- UV resistant



NANO FOR 2,5

NANO FOR 4

NANO MAM 4

*Kit with end connectors/
terminal blocks*

Kit with terminal blocks

NANO MAM 2,5



Nano Mam 2,5

Product	Formation and wires cross section (Max N° x mm ²)	Combination	Pieces for package	A x B x C (mm)
Nano Mam 2,5	3 x 1 - 2,5	3 through	2 pcs/ Blister	36 x 37 x 26



With one connector included for each Nano Mam

Nano Mam 4

Product	Formation and wires cross section (Max N° x mm ²)	Combination	Pieces for package	A x B x C (mm)
Nano Mam 4	3 x 1,5 - 4	3 through	1 pcs/ Blister	52 x 53 x 29

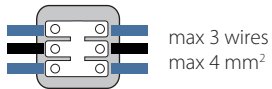

With one connector included for each Nano Mam

Nano For 2,5

Product	Formation and wires cross section (Max N° x mm ²)	Combination	Pieces for package	A x B x C (mm)
Nano For 2,5	3 x 1 - 2,5	3 connections / In/Out	1 pcs/ Blister	33 x 52 x 26



With one connector included for each Nano For

Nano For 4

Product	Formation and wires cross section (Max N° x mm ²)	Combination	Pieces for package	A x B x C (mm)
Nano For 4	3 x 1 - 4	3 connections / In/Out	1 pcs/ Blister	52 x 53 x 29



With one connector included for each Nano For



**Electrical performance:**

CEI EN 50393: 2006
as applicable

Gel: UL 94-HB 

Operating voltage: 0,6 / 1kV

Operating temperature 

Installation temperature: 
-40°C / +50°C

Fully submersible 

Can be used underground 

IPX8
OFFICIALLY
TESTED | **IMQ**

Bravo

The first "Gel-Box" with integrated connectors!

- Ready to use, quick, re-enterable!
- Self-locking connection block
- For rigid or flexible insulated wires from 1 a 6 mm²
- Immediately energizable
- For straight & branch connections
- For 1 or 3 cores connections
- Small, compact and transparent
- No shelf life
- Halogen free
- UV resistant

BRAVO 3-6

BRAVO 1-6





Bravo 1-6

Product	Formation and wires cross section		Pieces for package	A x B x C (mm)
	Straight or through (N° x mm ²)	Branch (N° x mm ²)		
Bravo 1-6	1 x 1 - 6	1 x 1 - 6	1 pcs/ Blister	50 x 29 x 22



Bravo 3-6

Product	Formation and wires cross section		Pieces for package	A x B x C (mm)
	Straight or through (N° x mm ²)	Branch (N° x mm ²)		
Bravo 3-6	2 x 1 - 6 3 x 1 - 6	2 x 1 - 6 3 x 1 - 6	1 pcs/ Blister	53 x 49 x 22



1. Connect

2. Fix

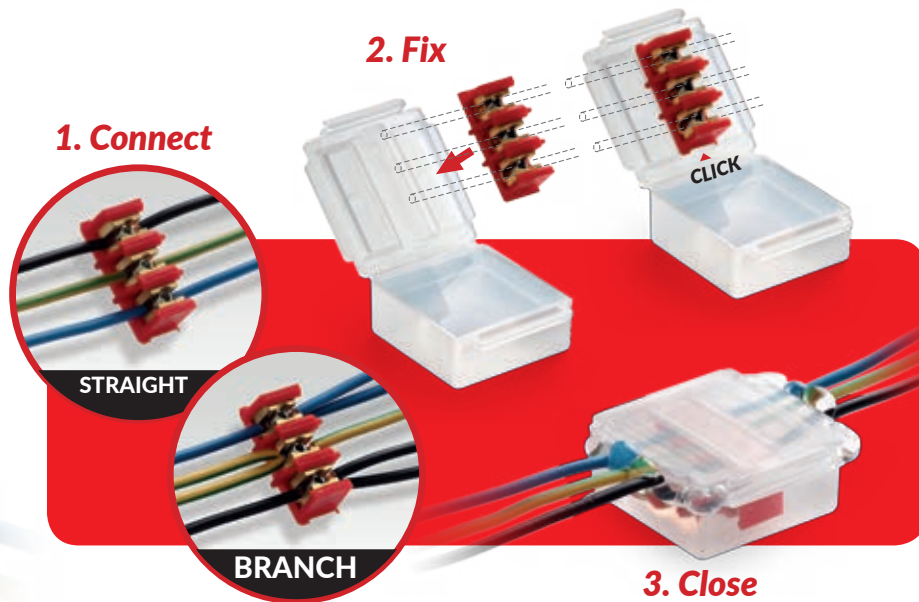

3. Close

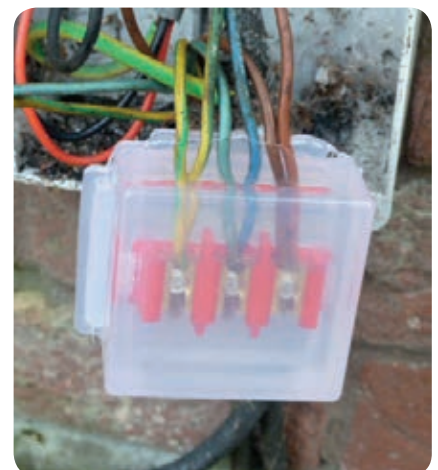





To choose the suitable accessory for

Gel Connection Accessories also suitable for continuous submersible use

IPX8
OFFICIALLY TESTED

IMQ

Gel: UL 94-HB 

Operating temperature 

Installation temperature:  -40°C / +50°C

Fully submersible 

Can be used underground 

GEL CONNECTION		Terminal blocks (chocolate block type)		End connectors/terminal blocks
		2x	3x	3x
Revolution	 HAPPY 0 41 x 28 x 19 mm			
	 HAPPY 1 45 x 37 x 24 mm			
	 HAPPY 2 53 x 39 x 24 mm			
Classic Gel Box Line	 ISAAC 30 x 27 x 23 mm			
	 PASCAL 36 x 37 x 26 mm			
	 WATT 30 x 42 x 26 mm			
	 JOULE 33 x 52 x 26 mm			
	 KELVIN 52 x 53 x 29 mm			
				

your application, begin with your preferred connector

First generation of lever connectors (e.g. WAGO 222 or similar)			Flat lever connectors (e.g. WAGO 221 type or similar)		
2x	3x	5x	2x	3x	5x
					
					
					
					
					
					
					





"Information given here, including photos and drawings, are only intended as a general description. Raytech is not responsible for its accuracy, completeness and possible utilisation for working purposes. Raytech may only be held responsible for the product included in standard sales terms and conditions and declines any possible liabilities for direct or indirect accidents and/or damages produced by wrong and inappropriate use. Each user must decide the best way to use it".

GEL CONNECTION

SMALL WATERPROOF ACCESSORIES FOR BIG INSTALLATIONS

IPX8
OFFICIALLY
TESTED | **IMQ**

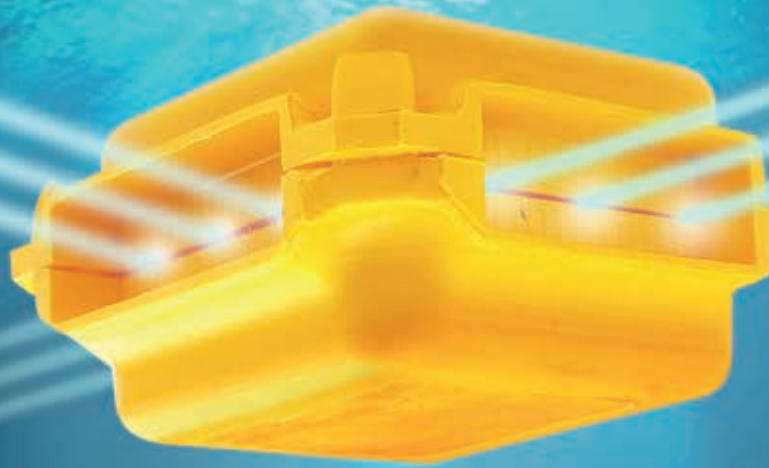

Ray tech®

CABLE ACCESSORIES COMPANY



RAYTECH S.r.l.
Via Enrico Fermi 11/13/17
Settimo Milanese (MI)
tel: +39 02 33500 147

www.raytech.it