



**Ray  
tech**®

CABLE ACCESSORIES COMPANY



# Ray Tech®

CABLE ACCESSORIES COMPANY

## Low Voltage page 4

Joints	» 6
Fillers	» 88
Kit IP68	» 108
Heat-shrink	» 120
Insulation tapes	» 130
Cable pullers and lubricants	» 138
Fire stop barriers	» 144
Specials	» 152

## Medium Voltage » 168

Cold-shrink	» 171
Heat-shrink	» 180
Heat-shrink 72 kV	» 196
Separable connectors	» 198
Sheaths and tapes up to 36 kV	» 200

## Heating Cables » 204

Domestic	» 208
Industrial	» 221
Comfort	» 231

---

Index by Product / Code	» 241
-------------------------	-------





# It all started with a Klik...

It was 1995 when we felt the need to design and construct an electrical cable jointing system that would be more durable and convenient to use. We wanted to offer a joint that was at the same time **quick, re-enterable and non-toxic**. From this idea, the revolutionary **Klik**, the first “pre-filled” joint, was born.

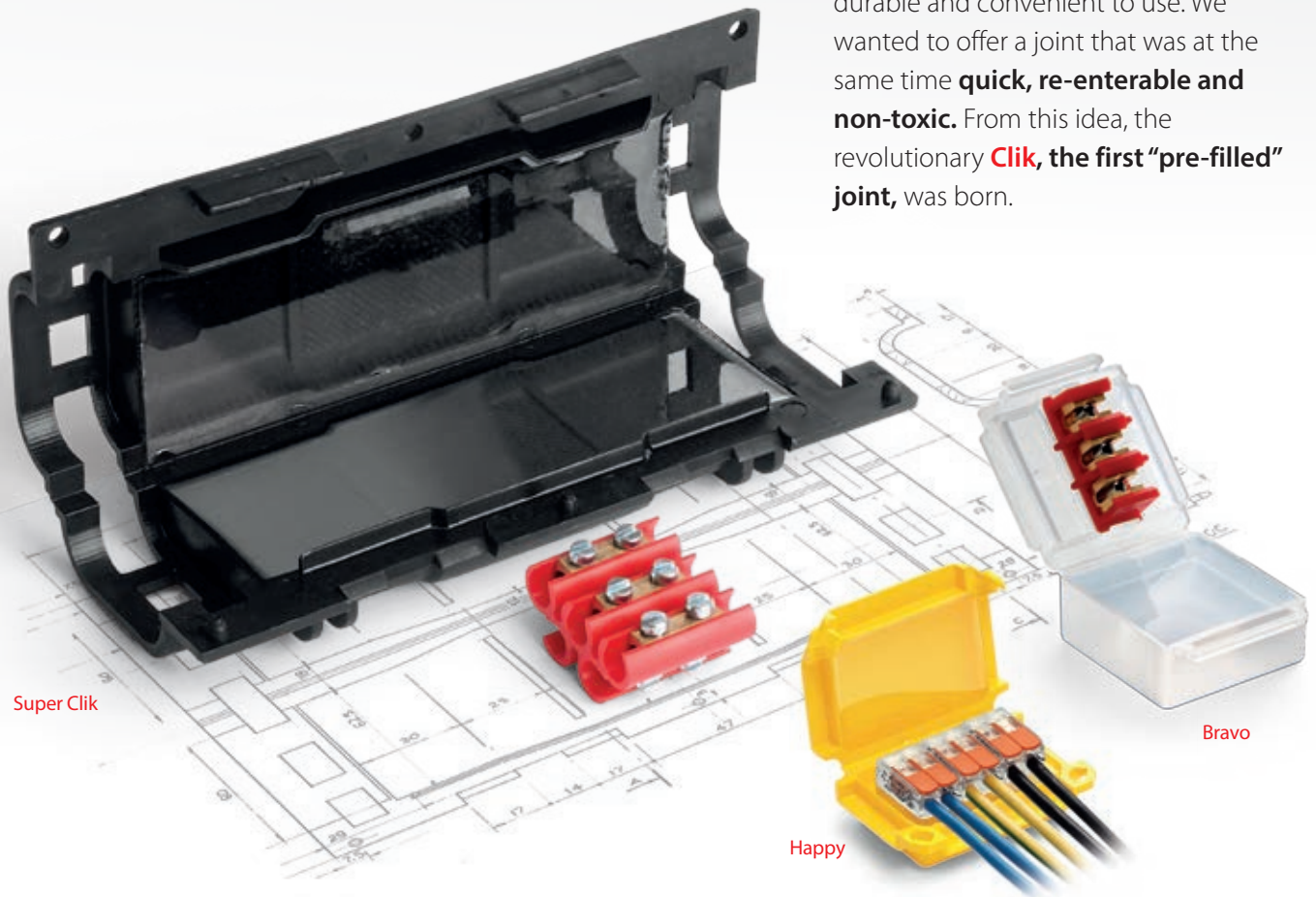

20.000 m<sup>2</sup>  
total which  
are home to:

**LABORATORY**  
recognized by IMQ,  
for running tests  
medium and low voltage  
according to HD 629.1 S2  
and EN50393.

**PHYSICAL/CHEMICAL  
LABORATORY**  
within which stringent technical  
parameters are established  
and set to guarantee the  
highest quality standards.





## 24 years of research and development

Passion for design and innovation has allowed **Raytech** to evolve and adapt to the needs of constantly expanding national and international market standards, as well as to meet the challenge of satisfying and surprising end users with new or improved products extremely rapidly, without ever skimping on the same scrupulous quality which has always distinguished them in the production field.

The performance specifications of **Raytech** products have been tested and certified inside our laboratories to ensure maximum reliability to even our most demanding installers, who can find our

products in **40 countries worldwide** through an established and highly qualified distribution network.

In an increasingly competitive and fast market, **Raytech** is known as a **precursor of the best and most inventive technologies**, for its integrity and passion which are the cornerstones of its twenty years in the business.

**Raytech**, located near Milano, the most important economic-financial area in Italy, is the **company with the widest range of accessories and components** for electrical cables in the world in terms of production.

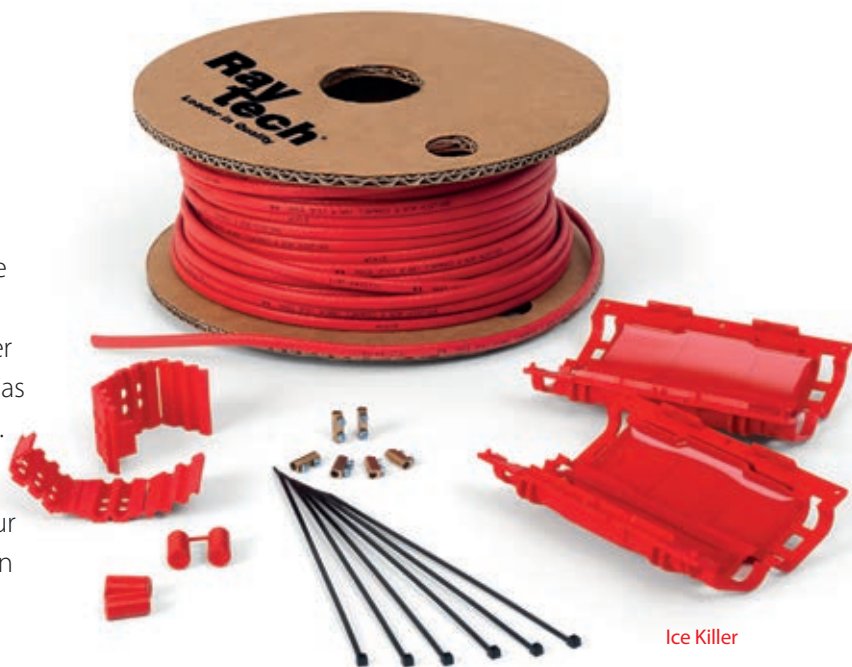

Ice Killer



### PRODUCTION SITE

implemented over the years, with machines of our own design, engineered to provide the market with innovative solutions or improvements that are reliable and effective over time.

### TEAM

highly qualified operators in accordance with ISO 9001:2015.

### STOCK

adequate to process orders within 24 hours of receipt.

# Raytech



### JOINTS



GEL CONNECTION  
PRE-FILLED  
FOR CASTING  
INJECTION  
SYSTEM PLUS  
SYSTEM FAST RP  
HEAT-SHRINK



### FILLERS



GEL  
GELGUM  
RUBBER  
RESIN



### KIT IP68



POWER KIT  
GEL LEADER PACK  
MAGIC BOX  
J-BOX  
DIY

page 6

88

108



# Low Voltage



## HEAT-SHRINK



THIN-WALL  
MEDIUM-WALL  
HEAVY-WALL  
WRAP AROUND  
POLE PROTECTION  
CAPS  
MOULDED PARTS

120



## INSULATION TAPES



PVC  
SELF-AMALGAMATING  
SPECIAL

130



## CABLE PULLERS and LUBRICANTS



LUBRICANTS  
NYLON PULLERS  
POLYESTER PULLERS  
SELF-STARTING  
PULLERS  
ACCESSORIES

138



## FIRE STOP BARRIERS



BAGS  
PANELS  
COLLARS  
PUTTY  
FOAM  
TUBULAR  
COMPOUND  
COVERINGS

144



## SPECIALS



GALACTIC LINE  
RUBBER LINE  
INDISPENSABLE

152



# JOINTS

## Gel Connection

PRE-FILLED GEL ACCESSORIES

page  
8

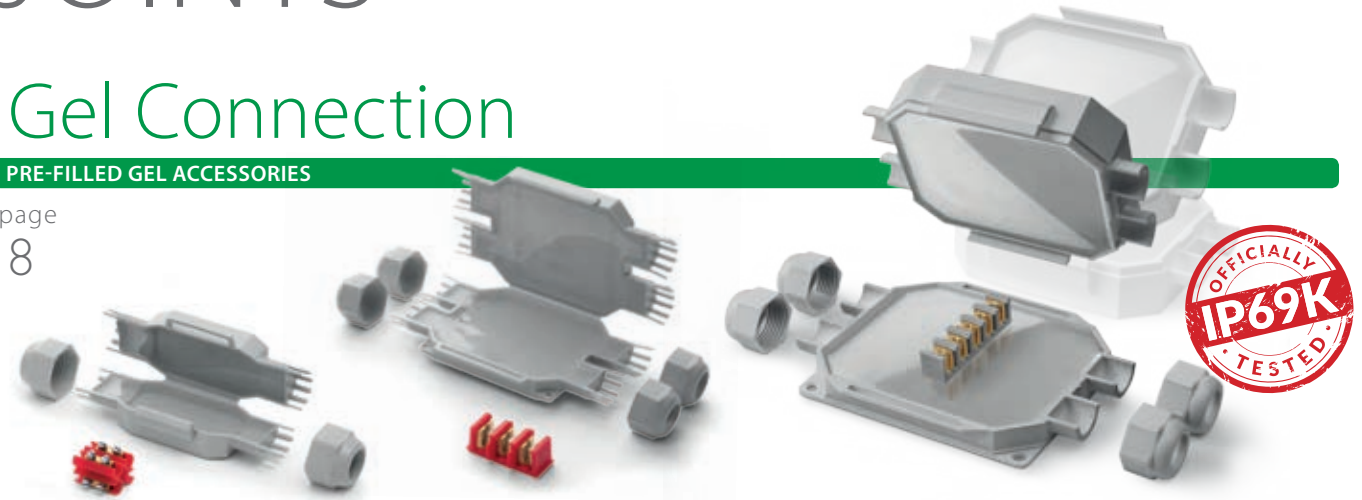

IPX8



Happy Line



Happy Line X6



Gel Box Line

IP68 e IP69K



Little Joint L



Little Joint Y



Little Joint X



Gel Cover Line



Nano Line



Bravo Line



Ready Box 120



Ready Box 90

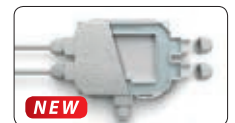

Fox Box

## Pre-filled

JOINTS FILLED WITH ALREADY CROSS-LINKED GEL

page  
38



Integrated connection



Super Klik



Rapid Joint IP68



Mini Rapid Joint IP68



King Joint

Free connection



Rapid Joint



Klik Fire / Klik Fire-A2A





# For casting

WITH CASTING FILLER

page  
51



Magic Power Joint

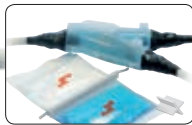

Magic Joint



Magic Joint Fire



Rubber Joint



Raycast

# Injection

WITH CARTRIDGE FILLER

page  
68



Wonder Joint

# System Plus

JOINTS EQUIPPED WITH COMPLETE CONNECTION SYSTEM

page  
70



Wonder Joint System Plus

Magic Power Joint System Plus

Magic Joint System Plus

Raycast System Plus

# System Fast RP

JOINTS WITH 4 SHEAR BOLT CONNECTORS

page  
76



Rapid Joint RIP 68

Magic Power Joint RP

Magic Joint RP

Raycast RP

GLV RP

# Heat-shrink

HEAT-SHRINK JOINTS

page  
80

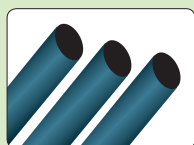

GLV



Terminals





# Happy

The revolutionary mini accessories with 3 entrances, pre-filled with gel and suitable for submersible installations (IPX8).

Designed in 3 dimensions to rapidly insulate and seal the most commonly used connectors. The 3 entrances not only guarantee the extreme flexibility in the range of these products but also by the housing accepting a wide variety of connectors.

**Electrical performance:**  
CEI EN 50393 as applicable  
(testing under water head of the accessory installed in a box)

**Gel:** UL 94-HB

Operating temperature

Installation temperature:   
-40°C / +50°C

Fully submersible

Can be used underground

**IPX8**  
OFFICIALLY TESTED | **IMQ**

- Extremely versatile - Ready to use - Re-enterable
- For rigid or flexible insulated wires up to 4 mm<sup>2</sup>
- Pre-filled with gel, non toxic and no shelf life
- Small compact and robust
- Halogen free
- UV resistant

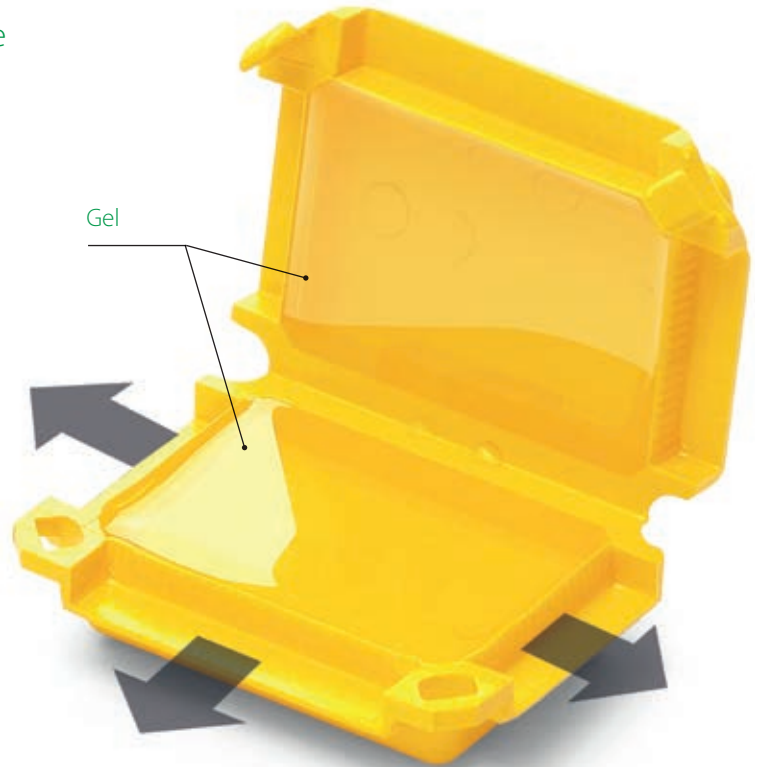
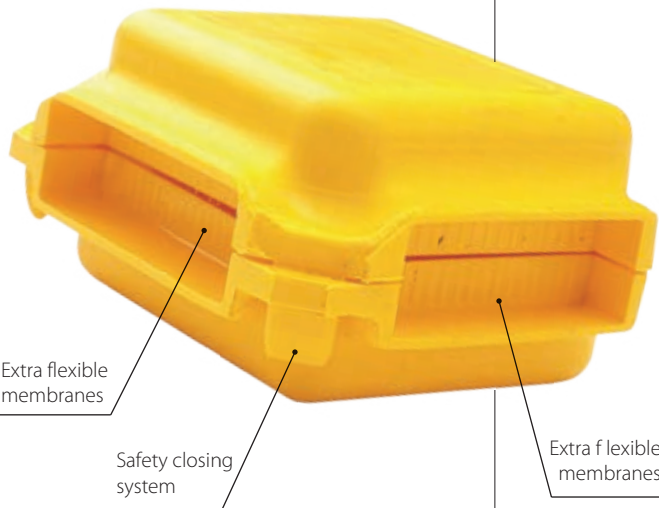

Configuration examples

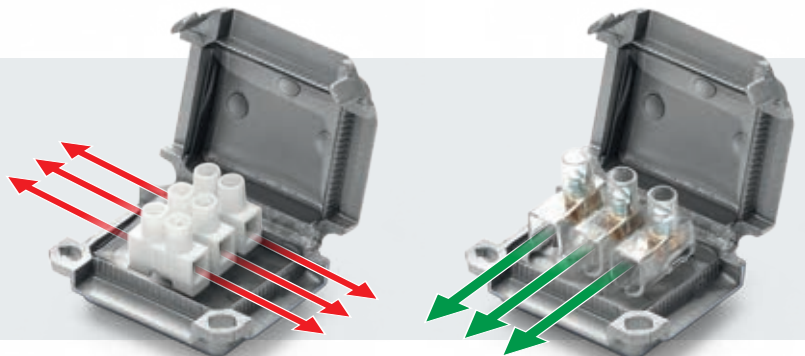





# Happy 0

Product	Pieces	Color	Description	A x B x C (mm)
Happy 0	x 4	●	Blister	41 x 28 x 19
Happy 0 Box12	x 12	○	Box	

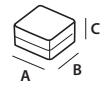

IDEAL FOR (or similar):

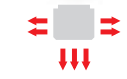

# Happy 1

Product	Pieces	Color	Description	A x B x C (mm)
Happy 1	x 2	●	Blister	45 x 37 x 24
Happy 1 Box10	x 10	○	Box	

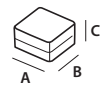

IDEAL FOR (or similar):



# Happy 2

Product	Pieces	Color	Description	A x B x C (mm)
Happy 2	x 1	●	Blister	53 x 39 x 24
Happy 2 Box7	x 7	○	Box	

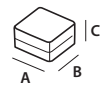

IDEAL FOR (or similar):

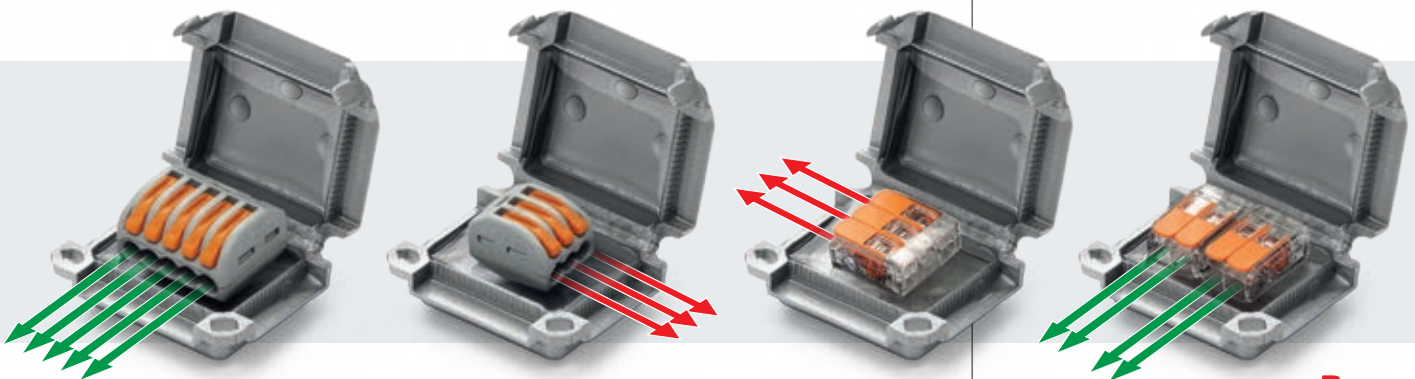



# Happy Joint

**Electrical performance:**  
CEI EN 50393 as applicable  
(testing under water head  
of the accessory installed in a box)

**Gel:** UL 94-HB 

Operating temperature 

Installation temperature:   
-40°C / +50°C

Fully submersible 

Can be used underground 

**IPX8**  
OFFICIALLY  
TESTED | **IMQ**

The revolutionary mini accessories with 3 entrances, pre-filled with gel and suitable for submersible installations (IPX8) complete with connectors.

- Extremely versatile - ready to use - re-enterable
- Small, compact and robust
- No need for tools
- Pre-filled with gel, non toxic and no shelf life
- Can energise immediately
- For straight and branch connections
- For rigid or flexible insulated wires up to 4 mm<sup>2</sup>
- Up to 5 conductors on one phase or up to two conductors on two or three phases
- Halogen free
- UV resistant

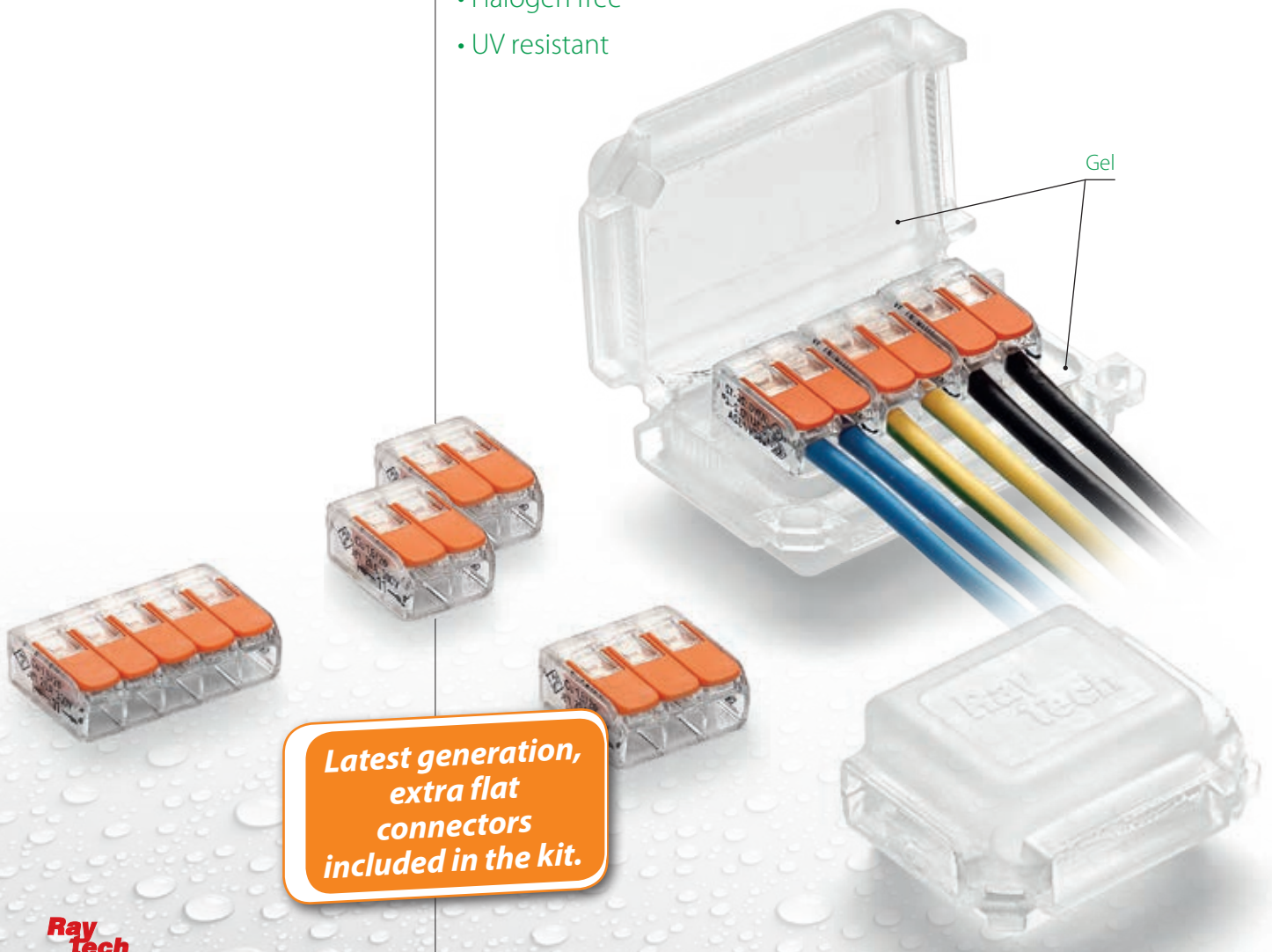

*Latest generation,  
extra flat  
connectors  
included in the kit.*



## Happy Joint 3

Product	Formation and wires cross section (Max N° x mm <sup>2</sup> )	Combination	Pieces for package	A x B x C (mm)
Happy Joint 3	3 x 1 - 4	2 through / 1 branch	4 pcs/ Blister	41 x 28 x 19



With one connector included for each Happy



## Happy Joint 4

Product	Formation and wires cross section (Max N° x mm <sup>2</sup> )	Combination	Pieces for package	A x B x C (mm)
Happy Joint 4	4 x 1 - 4	2 through / in/out	2 pcs/ Blister	45 x 37 x 24



With two connectors included for each Happy



## Happy Joint 5

Product	Formation and wires cross section (Max N° x mm <sup>2</sup> )	Combination	Pieces for package	A x B x C (mm)
Happy Joint 5	5 x 1 - 4	2 through / 3 branch	2 pcs/ Blister	45 x 37 x 24



With one connector included for each Happy



## Happy Joint 6

Product	Formation and wires cross section (Max N° x mm <sup>2</sup> )	Combination	Pieces for package	A x B x C (mm)
Happy Joint 6	6 x 1 - 4	3 through / in/out	1 pcs/ Blister	53 x 39 x 24



With three connectors included for each Happy







**Electrical performance:**  
CEI EN 50393 as applicable  
(testing under water head  
of the accessory installed in a box)

**Gel:** UL 94-HB

Operating temperature

Installation temperature:   
-40°C / +50°C

Fully submersible   
Can be used underground

**IPX8**  
OFFICIALLY  
TESTED | **IMQ**

# Happy Joint X6

The revolutionary mini accessories with 3 entrances, pre-filled with gel and suitable for submersible installations (IPX8) complete with connectors.

- Extremely versatile - ready to use - re-enterable
- Small, compact and robust
- No need for tools
- Pre-filled with gel, non toxic and no shelf life
- Can energise immediately
- For straight and branch connections
- For rigid or flexible insulated wires up to 6 mm<sup>2</sup>
- Up to 5 conductors on one phase or up to two conductors on two or three phases
- Halogen free
- UV resistant

**Ultra-thin terminals  
for wires up to 6 mm<sup>2</sup>  
included in the kit.**



3 x 6 mm<sup>2</sup>



2+2 x 6 mm<sup>2</sup>



5 x 6 mm<sup>2</sup>

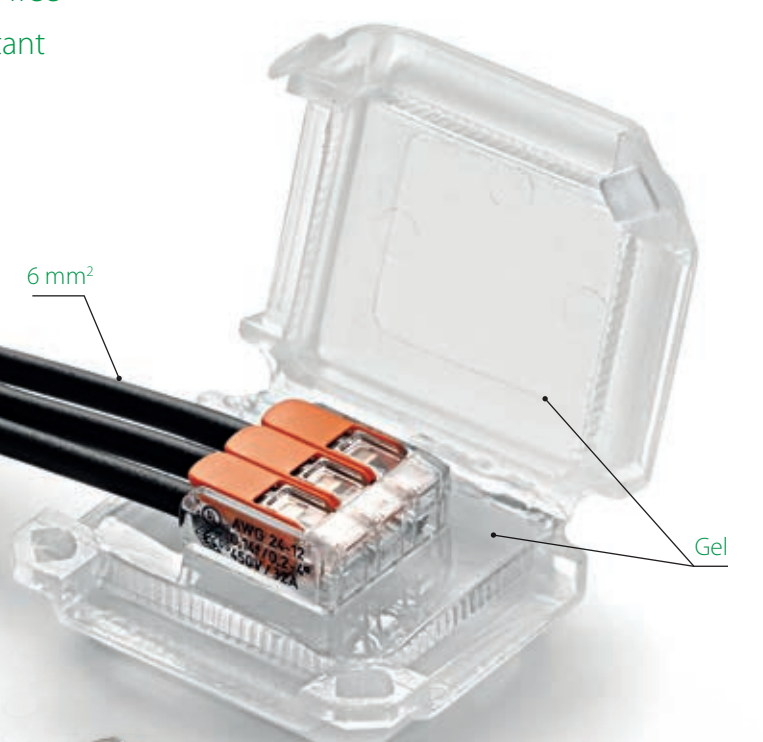



## Happy Joint 36

Product	Formation and wires cross section (Max N° x mm <sup>2</sup> )	Combination	Pieces for package	A x B x C (mm)
Happy Joint 36	3 x 1 - 6	2 through / 1 branch	2 pcs/ Blister	45 x 37 x 24



With one connector included for each Happy



## Happy Joint 46

Product	Formation and wires cross section (Max N° x mm <sup>2</sup> )	Combination	Pieces for package	A x B x C (mm)
Happy Joint 46	2+2 x 1 - 6	2 through / in/out	2 pcs/ Blister	45 x 37 x 24



With two connectors included for each Happy



## Happy Joint 56

Product	Formation and wires cross section (Max N° x mm <sup>2</sup> )	Combination	Pieces for package	A x B x C (mm)
Happy Joint 56	5 x 1 - 6	2 through / 3 branch	1 pcs/ Blister	53 x 39 x 24



With one connector included for each Happy



HAPPY JOINT 36

HAPPY JOINT 46



HAPPY JOINT 56





# Gel Box Line

Pre-filled gel accessories for sealing, protecting and making safe electrical connections.

- To put household systems in order
- For civil and industrial connections
- Also for submersible use
- Non-toxic and with no shelf life
- Versatile and ready to use
- Designed with dimensions suitable for the most commonly used connectors
- Halogen free
- UV resistant



**Electrical performance:**  
CEI EN 50393 as applicable  
(testing under water head of the accessory installed in a box)

**Gel:** UL 94-HB 

Operating temperature 

Installation temperature:   
-40°C / +50°C

Fully submersible 

Can be used underground 

**IPX8**  
OFFICIALLY TESTED 

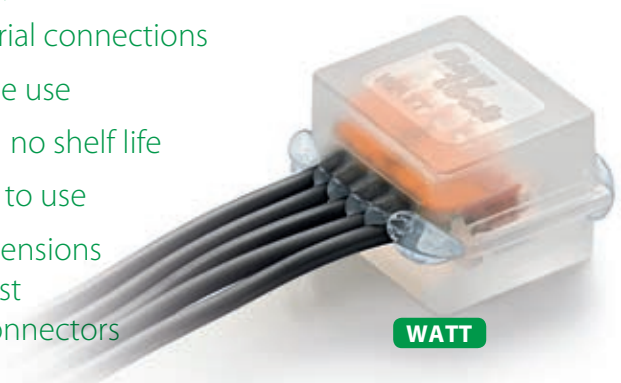

**GEL BOX LINE**  
*a simple way to bring indoor connectors outdoors*





JOULE

ISAAC

KELVIN

PASCAL

Gel



## Isaac



Product	Description	Package	A x B x C (mm)
Isaac 4	x 4 pcs	Blister	30 x 27 x 23
Isaac 4 P30	x 30 pcs	Box	
Isaac 4 MP *	x 50 pcs	Multipack	

IDEAL FOR (or similar):



## Pascal



Product	Description	Package	A x B x C (mm)
Pascal 6	x 2 pcs	Blister	36 x 37 x 26
Pascal 6 P15	x 15 pcs	Box	
Pascal 6 MP *	x 25 pcs	Multipack	

IDEAL FOR (or similar):



\* Also available the flame retardant version in the following colours: yellow, orange, blue or black.



## Watt

Product	Description	Package	A x B x C (mm)
Watt	x 2 pcs	Blister	
Watt P15	x 15 pcs	Box	30 x 42 x 26
Watt MP *	x 25 pcs	Multipack	

IDEAL FOR (or similar):



## Joule

Product	Description	Package	A x B x C (mm)
Joule	x 1 pcs	Blister	
Joule MP *	x 20 pcs	Multipack	33 x 52 x 26

IDEAL FOR (or similar):



## Kelvin

Product	Description	Package	A x B x C (mm)
Kelvin	x 1 pcs	Blister	
Kelvin P9	x 9 pcs	Box	52 x 53 x 29
Kelvin MP *	x 20 pcs	Multipack	

IDEAL FOR (or similar):



Also available the flame retardant version in the following colours: yellow, orange, blue or black.

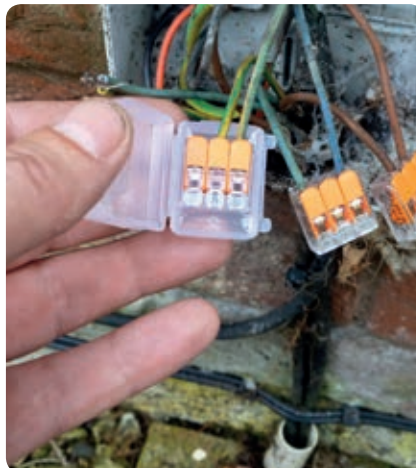



# Gel Box Line Kit

Complete with connectors.

## Pascal M2,5



Product	Description	Package	A x B x C (mm)
Pascal M2,5	12 pieces + 36 terminal blocks (2.5 mm <sup>2</sup> )	Box	36 x 37 x 26



## Kelvin M4



Product	Description	Package	A x B x C (mm)
Kelvin M4	6 pieces + 24 terminal blocks (4 mm <sup>2</sup> )	Box	52 x 53 x 29

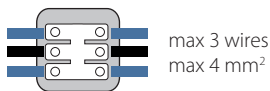

## Watt +



Product	Description	Package	A x B x C (mm)
Watt + 1.5	10 pieces + 30 end connectors/terminal blocks (1.5 mm <sup>2</sup> )	Box	30 x 42 x 26
Watt + 2.5	10 pieces + 30 end connectors/terminal blocks (2.5 mm <sup>2</sup> )	Box	

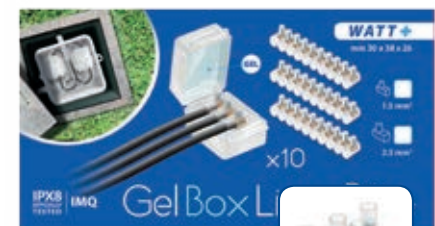

## Kelvin +



Product	Description	Package	A x B x C (mm)
Kelvin + 4	10 pieces + 30 end connectors/terminal blocks (4 mm <sup>2</sup> )	Box	52 x 53 x 29
Kelvin + 6	10 pieces + 30 end connectors/terminal blocks (6 mm <sup>2</sup> )	Box	
Kelvin 6+4	6 pieces + 20 end connectors/terminal blocks (4 mm <sup>2</sup> )	Box	
Kelvin 6+6	6 pieces + 20 end connectors/terminal blocks (6 mm <sup>2</sup> )	Box	





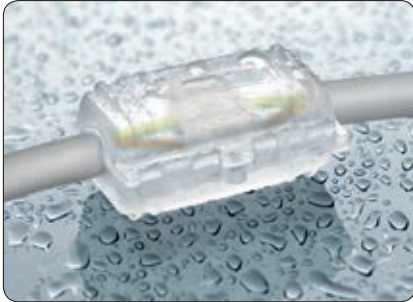

**Electrical performance:**  
CEI EN 50393 with connectors complying with EN 61238-1 (with testing under water head and water between the cable cores)  
Class 2 in accordance with CEI 64-8.

**Gel:** UL 94-HB

Operating temperature

Installation temperature: -40°C / +50°C

**IPX8**  
OFFICIALLY TESTED **IMQ**

# Gel Cover Line

Pre-filled gel accessories for straight connections, for the protection, safety and covering of electrical connections using strip connectors or alternatives.

- For 3 x 1 to 6 mm<sup>2</sup> cables or 3 insulated wires
- For civil and industrial connections
- To put household systems in order
- Also for underwater use
- Non-toxic and with no shelf life
- Halogen free
- UV resistant

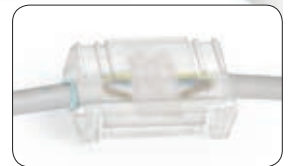
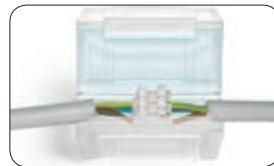
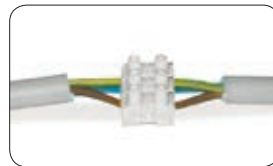
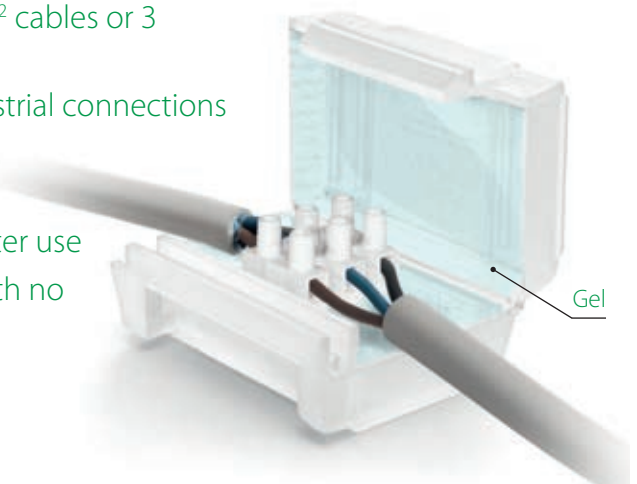

# OHM & BAR

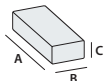

Product	Housed connectors type	Pieces for package	Package type	Dimensions A x B x C (mm)
OHM	2 from 4 mm <sup>2</sup>	1	Blister	61 x 35 x 28
OHMp11	2 from 4 mm <sup>2</sup>	11	Box	61 x 35 x 28
BAR	3 from 4 mm <sup>2</sup> / 6 mm <sup>2</sup>	1	Blister	63 x 41 x 28
BARp9	3 from 4 mm <sup>2</sup> / 6 mm <sup>2</sup>	9	Box	63 x 41 x 28



# Mammut Gel Cover

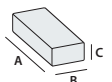

Product	Housed connectors type	Pieces for package	Package type	Dimensions A x B x C (mm)
Gel Cover 4	2 from 4 mm <sup>2</sup>	1	Blister	61 x 35 x 28
Mammut Gel Cover	2 from 4 mm <sup>2</sup>	8	Box	61 x 35 x 28
Gel Cover 6	3 from 4 mm <sup>2</sup> / 6 mm <sup>2</sup>	1	Blister	63 x 41 x 28
Mammut Gel Cover 6	3 from 4 mm <sup>2</sup> / 6 mm <sup>2</sup>	6	Box	63 x 41 x 28

No flame propagation. CEI 20-35 • IEC 60332-1 • HD405-1 (as applicable). **Casing mix:** UL 94-V2

## Installation examples







# Nano Joint

**Electrical performance:**  
CEI EN 50393 as applicable  
(testing under water head  
of the accessory installed in a box)

Gel: UL 94-HB

Operating temperature

Installation temperature:   
-40°C / +50°C

Fully submersible

Can be used underground

**IPX8**  
OFFICIALLY  
TESTED | **IMQ**

Pre-filled gel accessories to seal, protect and make safe electrical connections.  
Inclusive of connectors

- Ready to use, quick, re-enterable!
- No tools required
- Can energise immediately
- For straight & branch connections
- For rigid or flexible insulated wires from 1 a 4 mm<sup>2</sup>
- For 1, 2 and 3 cores connections
- Up to 5 conductors on one phase or up to 2 conductors on two or three phase
- Small, compact and resistant
- No shelf life
- Halogen free
- UV resistant



**NANO JOINT 3**

**NANO JOINT 5**

**NANO JOINT 6**

*Latest generation,  
extra flat  
connectors  
included in the kit.*





## Nano 3

Product	Formation and wires cross section (Max N° x mm <sup>2</sup> )	Combination	Pieces for package	A x B x C (mm)
Nano 3	3 x 1 - 4	2 through / 1 branch	4 pcs Blister	30 x 27 x 23



With one connector included for each Nano Joint



## Nano 5

Product	Formation and wires cross section (Max N° x mm <sup>2</sup> )	Combination	Pieces for package	A x B x C (mm)
Nano 5	5 x 1 - 4	2 through / 3 branch	2 pcs Blister	30 x 42 x 26



With one connector included for each Nano Joint



## Nano 6

Product	Formation and wires cross section (Max N° x mm <sup>2</sup> )	Combination	Pieces for package	A x B x C (mm)
Nano 6	6 x 1 - 4	3 through / In/Out	1 pcs Blister	33 x 52 x 26



With three connectors included for each Nano Joint





# Nano Mam - For

**Electrical performance:**  
CEI EN 50393 as applicable  
(testing under water head  
of the accessory installed in a box)

Gel: UL 94-HB 

Operating temperature 

Installation temperature:   
-40°C / +50°C

Fully submersible 

Can be used underground 

**IPX8**  
OFFICIALLY  
TESTED **IMQ**

Pre-filled gel accessories to seal, protect and make safe electrical connections. Inclusive of connectors.

- Ready to use, quick, re-enterable!
- Ideal for outdoor & underground installations, fully submersible
- Immediately energizable
- For rigid or flexible insulated wires from 1 a 4 mm<sup>2</sup>
- For 1, 2 or 3 cores connections
- Small, compact and resistant
- No shelf life
- Halogen free
- UV resistant



NANO FOR 2,5

NANO FOR 4

NANO MAM 4

*Kit with end  
connectors/  
terminal blocks*

*Kit with  
terminal blocks*

NANO MAM 2,5





## Nano Mam 2,5

Product	Formation and wires cross section (Max N° x mm <sup>2</sup> )	Combination	Pieces for package	A x B x C (mm)
Nano Mam 2,5	3 x 1 - 2,5	3 through	2 pcs/ Blister	36 x 37 x 26



With one connector included for each Nano Mam

## Nano Mam 4

Product	Formation and wires cross section (Max N° x mm <sup>2</sup> )	Combination	Pieces for package	A x B x C (mm)
Nano Mam 4	3 x 1,5 - 4	3 through	1 pcs/ Blister	52 x 53 x 29

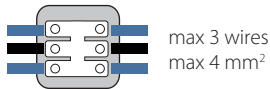

With one connector included for each Nano Mam

## Nano For 2,5

Product	Formation and wires cross section (Max N° x mm <sup>2</sup> )	Combination	Pieces for package	A x B x C (mm)
Nano For 2,5	3 x 1 - 2,5	3 connections / In/Out	1 pcs/ Blister	33 x 52 x 26



With one connector included for each Nano For

## Nano For 4

Product	Formation and wires cross section (Max N° x mm <sup>2</sup> )	Combination	Pieces for package	A x B x C (mm)
Nano For 4	3 x 1 - 4	3 connections / In/Out	1 pcs/ Blister	52 x 53 x 29



With one connector included for each Nano For









To choose the suitable accessory for your

**Gel Connection Accessories also suitable for continuous submersible use**

**IPX8 OFFICIALLY TESTED** | **IMQ**

Gel: UL 94-HB 

Operating temperature 













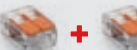

Installation temperature:  -40°C / +50°C

Fully submersible 

Can be used underground 

GEL CONNECTION		Terminal blocks (chocolate block type)		End connectors/terminal blocks
		2x	3x	3x
<b>Revolution</b>	 <b>HAPPY 0</b> 41 x 28 x 19 mm			
	 <b>HAPPY 1</b> 45 x 37 x 24 mm			
	 <b>HAPPY 2</b> 53 x 39 x 24 mm			
<b>Classic Gel Box Line</b>	 <b>ISAAC</b> 30 x 27 x 23 mm			
	 <b>PASCAL</b> 36 x 37 x 26 mm			
	 <b>WATT</b> 30 x 42 x 26 mm			
	 <b>JOULE</b> 33 x 52 x 26 mm			
	 <b>KELVIN</b> 52 x 53 x 29 mm			
				

application, begin with your preferred connector.

First generation of lever connectors (e.g. WAGO 222 or similar)			Flat lever connectors (e.g. WAGO 221 type or similar)		
2x	3x	5x	2x	3x	5x
			 4-6 mm <sup>2</sup>	 4-6 mm <sup>2</sup>	
			 4-6 mm <sup>2</sup>	 4-6 mm <sup>2</sup>	 4 mm <sup>2</sup>
			 4-6 mm <sup>2</sup>	 4-6 mm <sup>2</sup>	 6 mm <sup>2</sup>

			 4 mm <sup>2</sup>	 4 mm <sup>2</sup>	
					
			 4 mm <sup>2</sup>		 4 mm <sup>2</sup>
			 4 mm <sup>2</sup>		 4 mm <sup>2</sup>



# Bravo

The first "Gel-Box" with integrated connectors!

- Ready to use, quick, re-enterable!
- For rigid or flexible insulated wires from 1 a 6 mm<sup>2</sup>
- Immediately energizable
- For straight & branch connections
- For 1 or 3 cores connections
- Small, compact and transparent
- No shelf life
- Halogen free and UV resistant

**Electrical performance:**  
CEI EN 50393 as applicable  
(testing under water head  
of the accessory installed in a box)

Gel: UL 94-HB 

Operating voltage: 0,6 / 1kV

Operating temperature 

Installation temperature:   
-40°C / +50°C

Fully submersible 

Can be used underground 

**IPX8**  
OFFICIALLY  
TESTED | **IMQ**

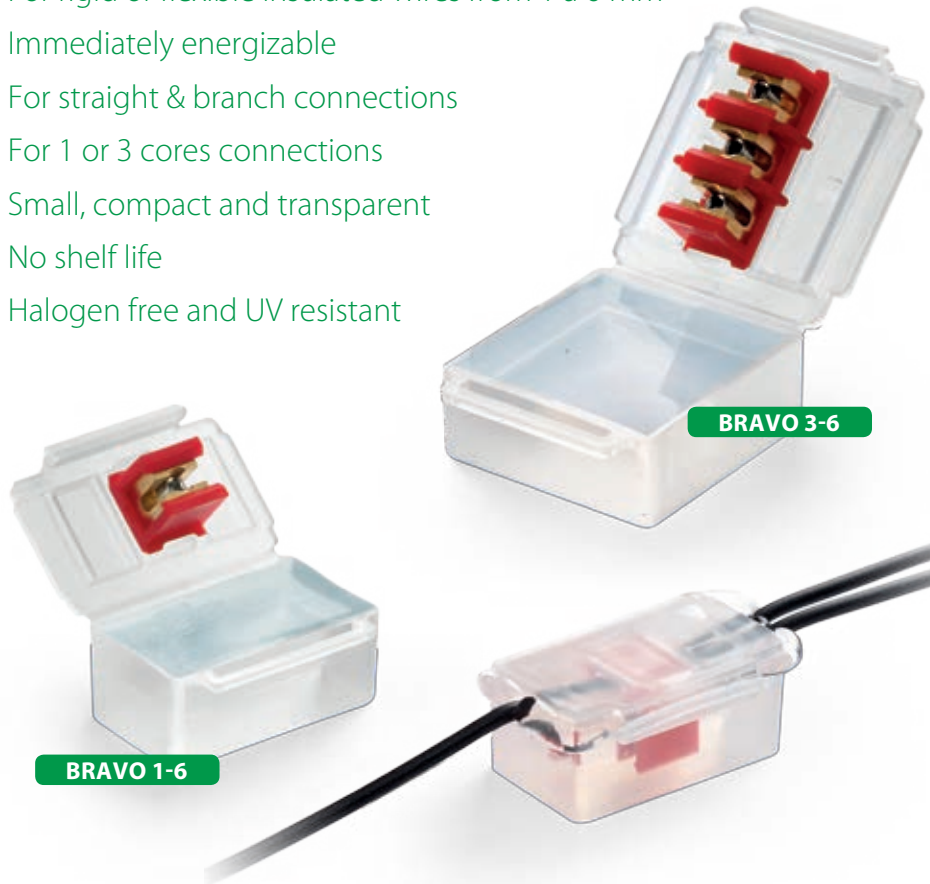

# Mini Bravo

Extra-flat mini box with terminal block.

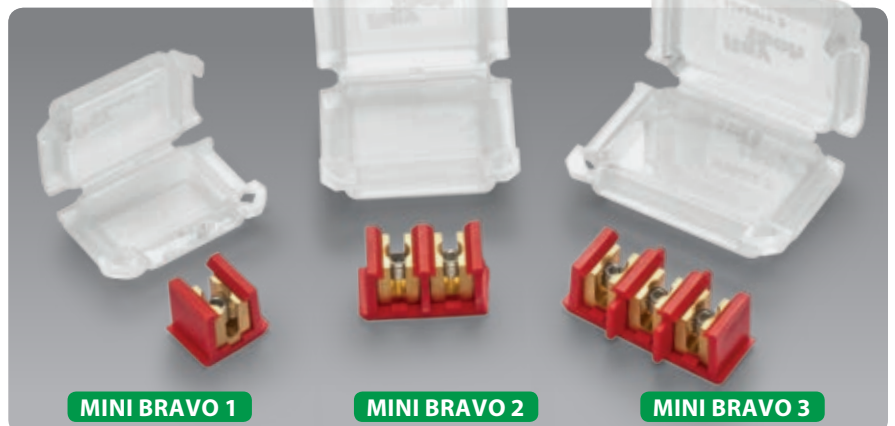





Bravo - Self-locking connection block.

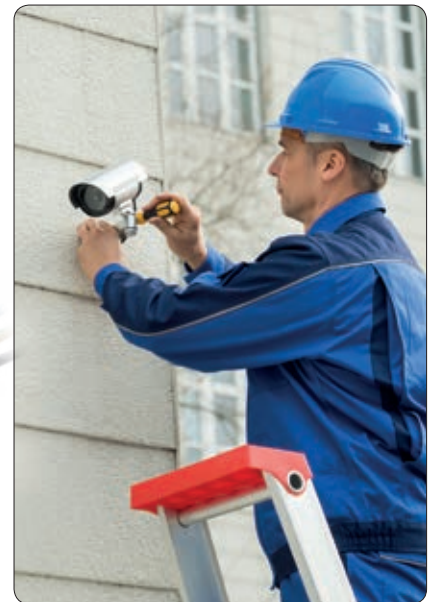
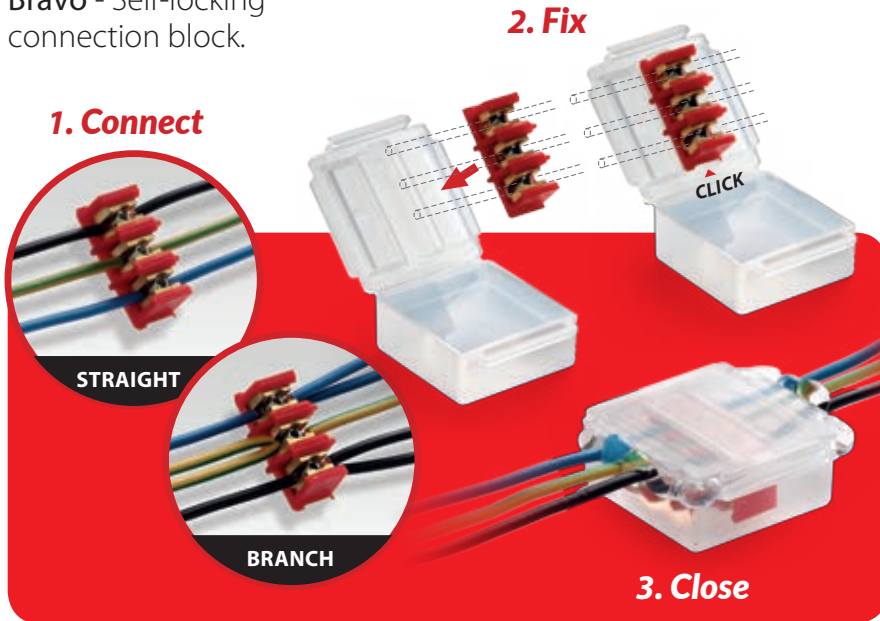

Bravo

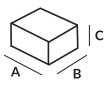
Product	Formation and wires cross section		Pieces for package	 A x B x C (mm)
	Straight or through (N° x mm <sup>2</sup> )	Branch (N° x mm <sup>2</sup> )		
Bravo 1-6	1 x 1 - 6	1 x 1 - 6	1 pcs/ Blister	50 x 29 x 22
Bravo 3-6	2 x 1 - 6 3 x 1 - 6	2 x 1 - 6 3 x 1 - 6	1 pcs/ Blister	53 x 49 x 22

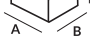

Mini Bravo

Product	Formation and wires cross section		Pieces for package	 A x B x C (mm)
	Straight or through (N° x mm <sup>2</sup> )	Branch (N° x mm <sup>2</sup> )		
Mini Bravo 1	1 x 1 - 4	1 x 1 - 4	3 pcs/ Blister	41 x 28 x 19
Mini Bravo 2	2 x 1 - 4	2 x 1 - 4	1 pcs/ Blister	45 x 37 x 24
Mini Bravo 3	3 x 1 - 4	3 x 1 - 4	1 pcs/ Blister	53 x 39 x 24





Electrical performance:  
CEI EN 50393  
as applicable

Gel: UL 94-HB

Operating temperature

Installation temperature:  
-40°C / +50°C

Fully submersible

Can be used underground

IP68  
OFFICIALLY  
TESTED

IP69K  
OFFICIALLY  
TESTED

# Little Joint L

IP68 and IP69K, gel pre-filled micro joint, space-saver complete with connectors and with minimal aesthetic impact.

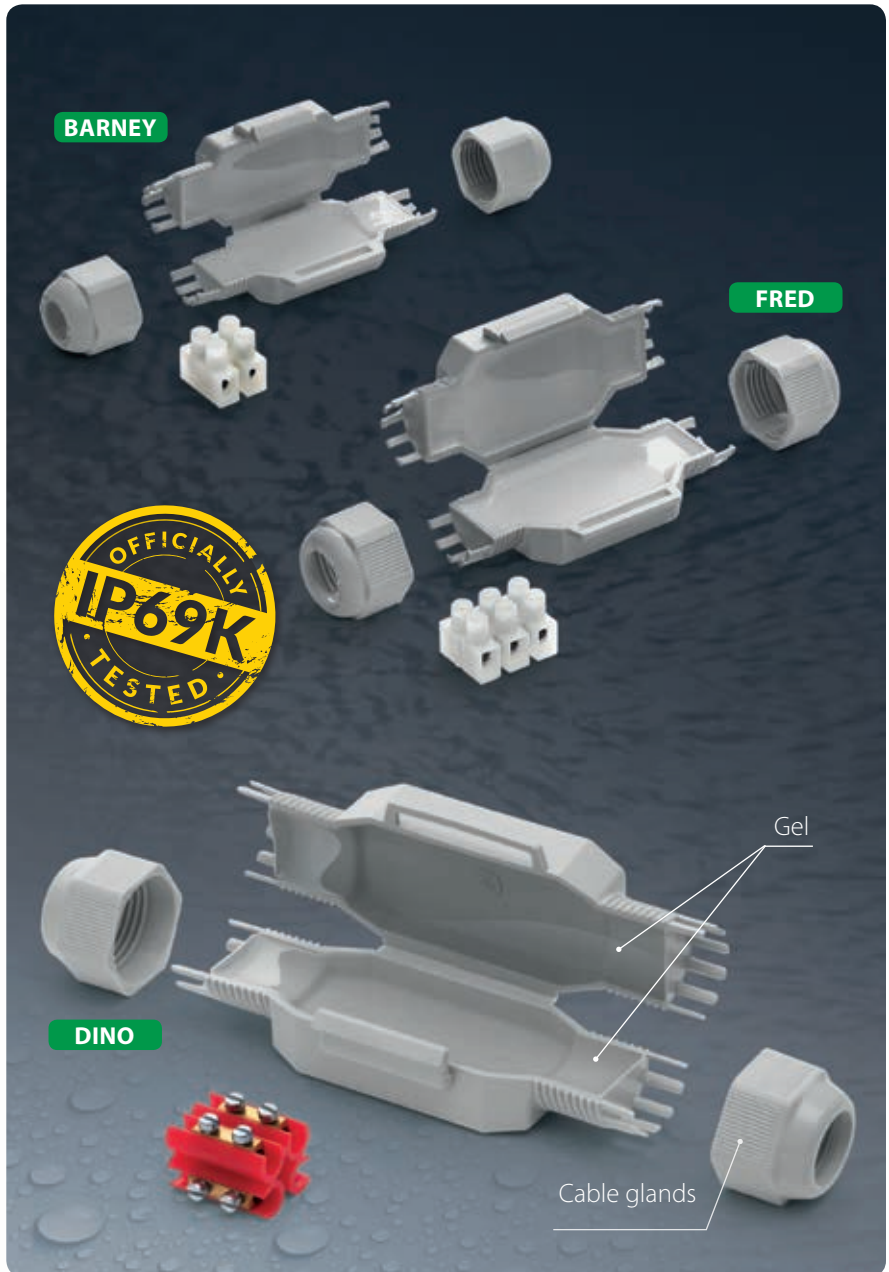

- Equipped with cable glands to avoid accidental cable traction
- Complete with screw connectors
- Pre-filled with non-toxic, non-classified gel
- Very compact and ready to use
- Always re-enterable
- Halogen free & UV resistant

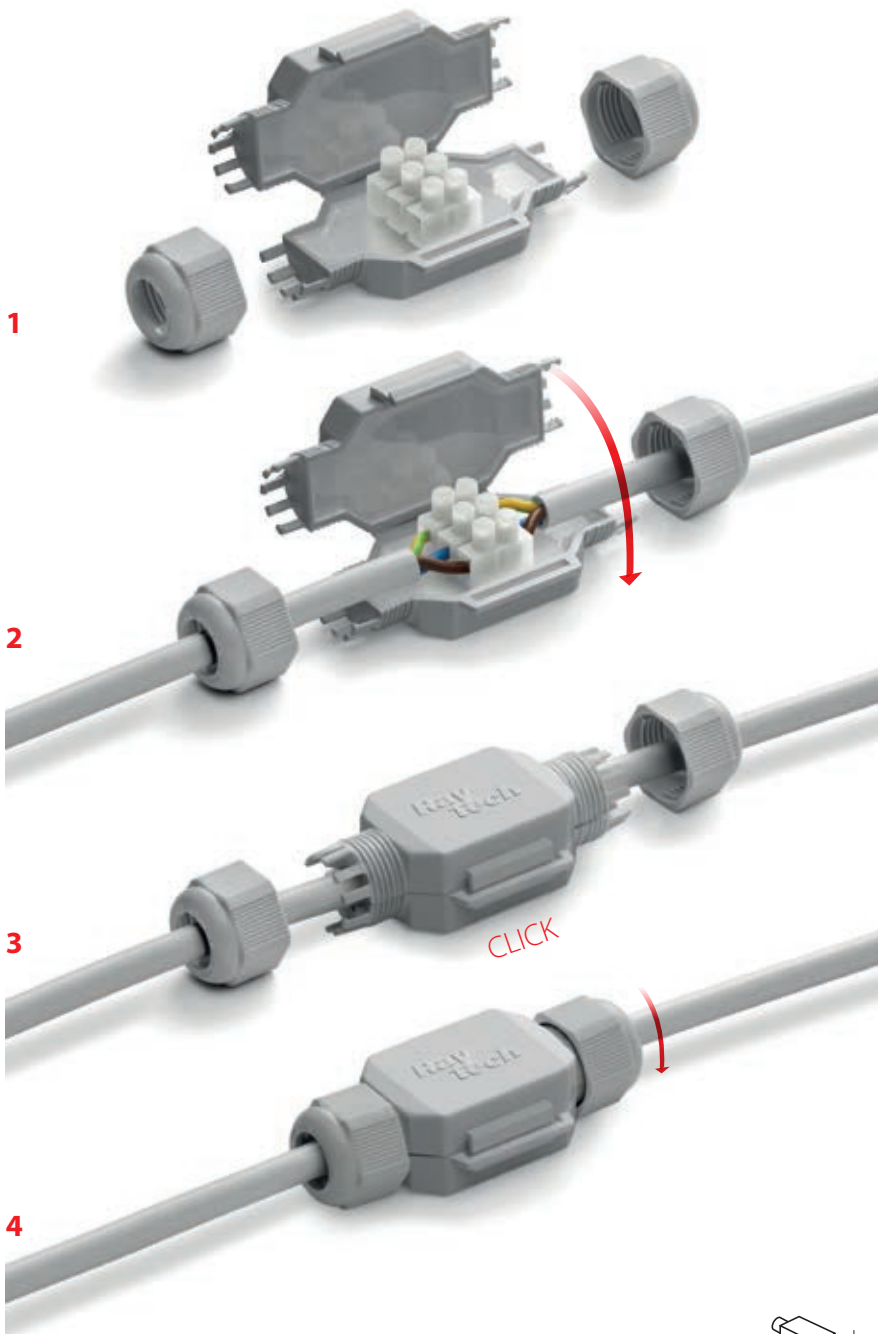

For use in traps, in lampholders for LED spotlights, especially in the presence of water and moisture, thanks to its very small size.



**LittleJoint L**

Product	Colour	Connector	Cable formation max (N° x mm²)	Ø cables min - max (mm)	Pieces / Pack	A x B x C (mm)
Barney	●				1 / Blister	
Barney - N	●		2 x 2,5	6 - 10	1 / Blister	75 x 28 x 19
Barney MP	●				10 / Multipack	
Fred	●				1 / Blister	
Fred - N	●		3 x 2,5	8 - 13	1 / Blister	80 x 36 x 23
Fred MP	●				10 / Multipack	
Fred/4	●		3 x 4	8 - 13	1 / Blister	80 x 36 x 23
Fred/4 - N	●				1 / Blister	
Dino	●		4 x 4	10 - 16	1 / Blister	125 x 43 x 35
Dino - N	●				1 / Blister	

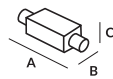





**Electrical performance:**  
CEI EN 50393  
as applicable

**Gel:** UL 94-HB

Operating temperature

Installation temperature:   
-40°C / +50°C

Fully submersible

Can be used underground

**IP68**  
OFFICIALLY TESTED | **IMQ**

**IP69K**  
OFFICIALLY TESTED

# Little Joint Y

Barney Y and Fred Y micro joints for branch connections complete with terminal block.

Extremely compact and space-saving, pre-filled with soft, highly conformable gel. With minimal aesthetic impact and visually pleasing. Equipped with integrated cable glands for IP68 and IP69K degree of ingress protection and cable retention.



- Equipped with 3 cable glands to avoid accidental cable traction
- Complete with terminal boards with screw connectors
- Pre-filled with classified non-toxic gel
- Extremely compact and ready to install
- Always re-enterable
- Halogen Free & UV resistant
- Ideal for branch connections in lighting systems for gardens, steps and stairways, pedestrian crossings, etc.





Barney Y - Installation sequence

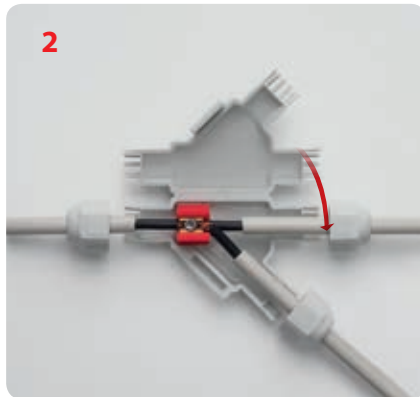
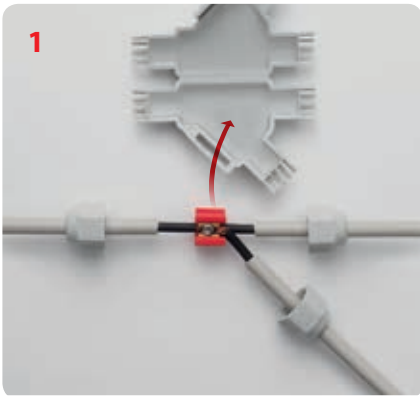

Fred Y - Installation sequence

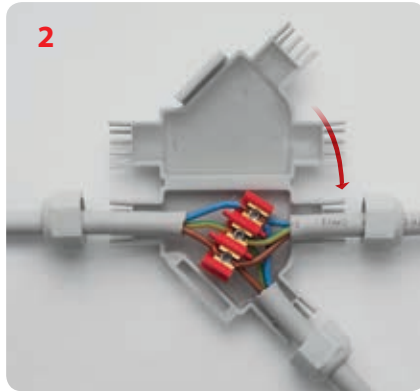
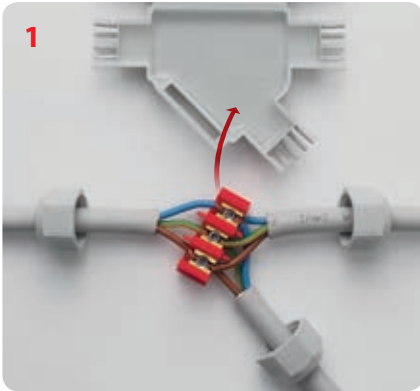

For use in traps. The ideal accessory for branch connections from a through cable to light fittings and spotlights. Suitable in applications where there is presence of water and moisture.

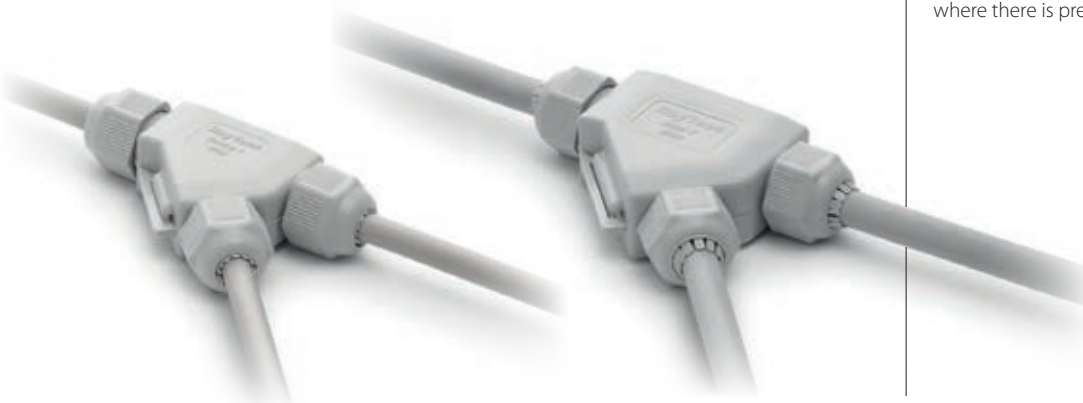

LittleJoint Y

Product	Colour	Connector	Cable formation max (N° x mm <sup>2</sup> )		Ø cables min - max (mm)	Pieces / Pack	A x B x C (mm)
			Through	Branch			
Barney Y	●		1 x 4 1 x 2,5	1 x 1,5 1 x 2,5	6 - 10	1 / Blister	85 x 55 x 22
Barney Y - N	●					1 / Blister	
Fred Y	●		3 x 4 3 x 2,5	3 x 1,5 3 x 2,5	8 - 13	1 / Blister	110 x 72 x 25
Fred Y - N	●					1 / Blister	

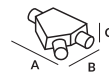



**Electrical performance:**  
CEI EN 50393  
as applicable

**Gel:** UL 94-HB

Operating temperature

Installation temperature:   
-40°C / +50°C

Fully submersible

Can be used underground

**IP68**  
OFFICIALLY TESTED **IMQ**

**IP69K**  
OFFICIALLY TESTED

# Little Joint X

This 4 entrances micro joint IP68 and IP69K for multiple branches is pre-filled with conformable gel, is ready to use, extremely compact and with minimal aesthetic impact.

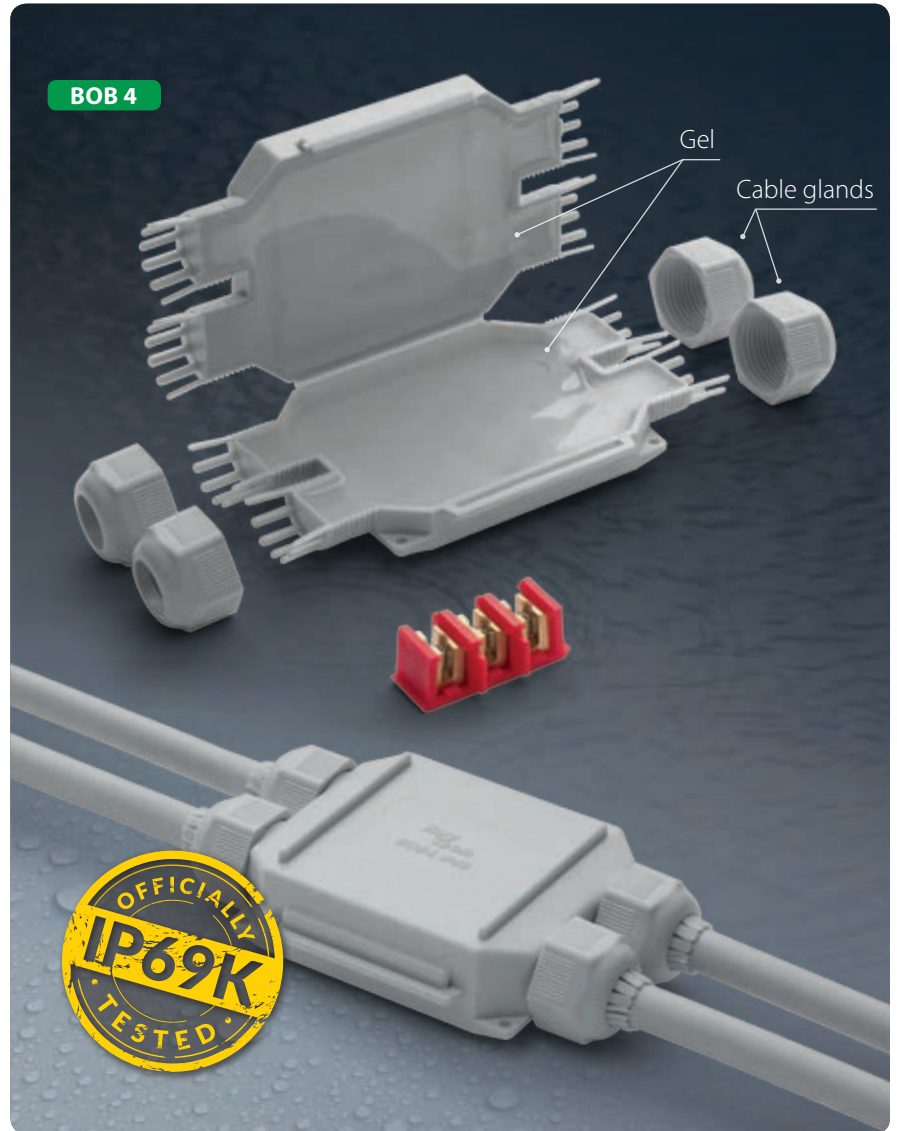

- Equipped with cable gland to avoid accidental cable traction
- Complete with 3-screw connector system
- Pre-filled with classified non-toxic gel
- Extremely compact
- Always re-enterable
- Provided with holes for wall installation
- Halogen free & UV resistant
- Lets you create multiple connection systems







Some installation possibilities for *Bob 4*

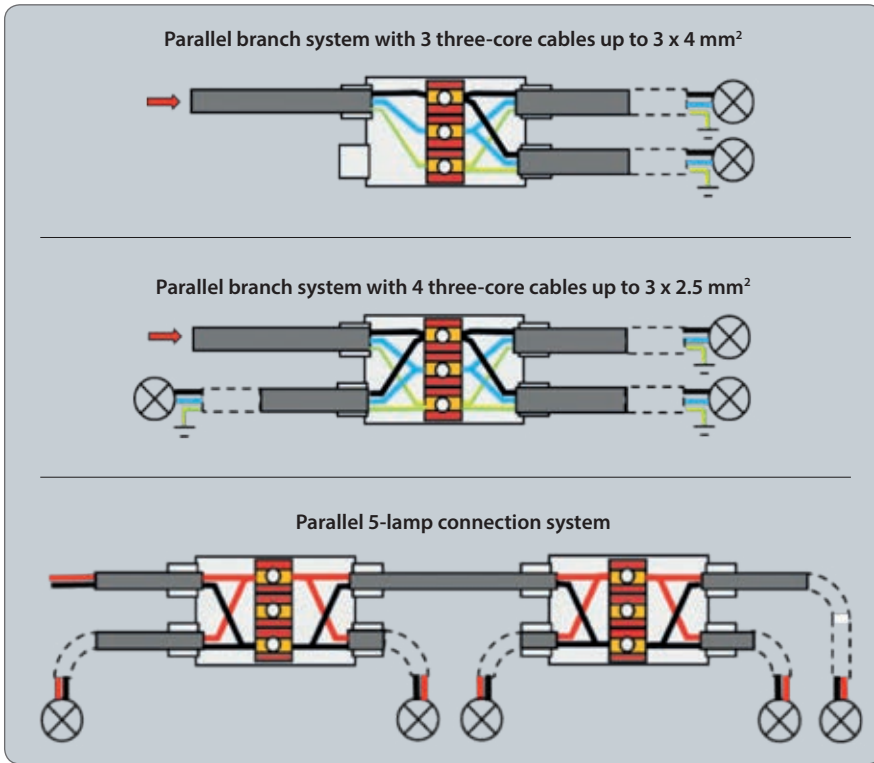

Can be installed with Mammut type connector (not included)

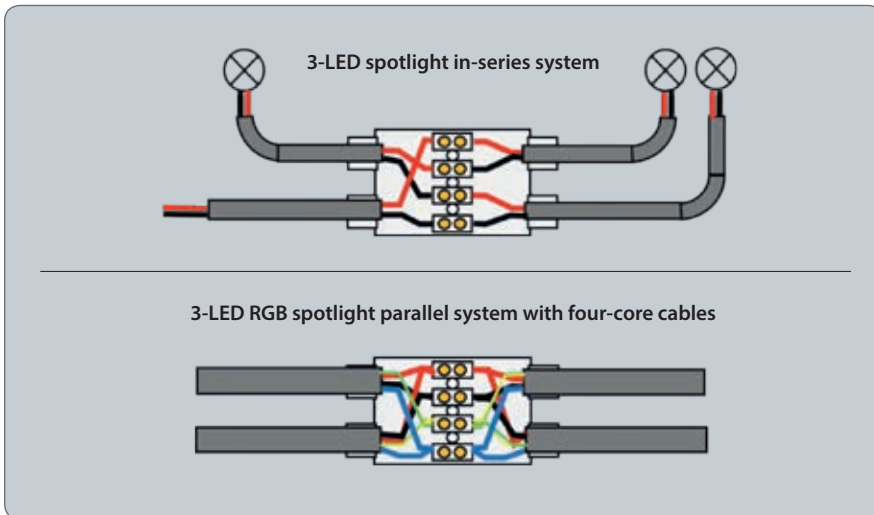

Installation sequence

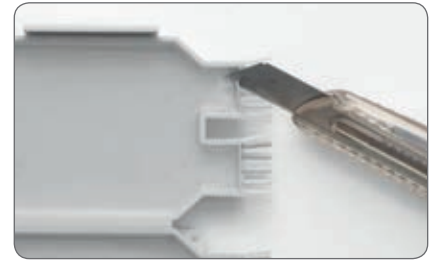

Cutting the membrane

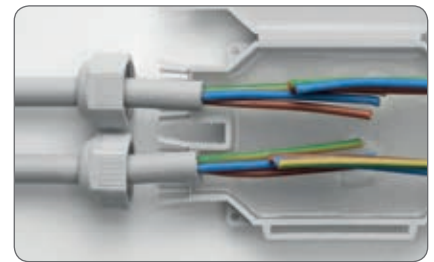

Glands pre-threading and cable positioning

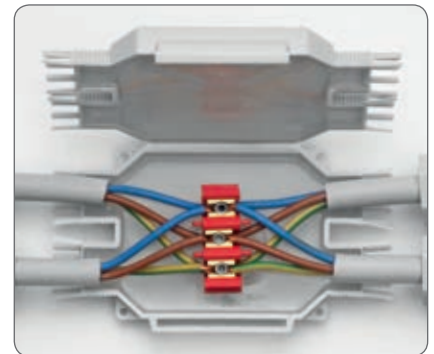

Conductor connection



Gland closing and tightening

LittleJoint X

Product	Colour	Connector	Cable formation max (N° x mm <sup>2</sup> )		Ø cables min - max (mm)	Pieces / Pack	A x B x C (mm)
			Through	Branch			
Bob 4	●		1 cable 3 x 4	2 cables 3 x 4	8 - 13	1 / Blister	105 x 65 x 25
Bob 4 - N	●		3 cables 3 x 2,5	3 cables 3 x 2,5			

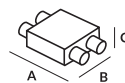



**Electrical performance:**  
CEI EN 50393  
as applicable

**Gel:** UL 94-HB 

**Halogen free:**  
according to CEI EN 50267 2-2  
**Self-extinguishing and  
resistant to abnormal  
heat and fire:**  
Glow wire test a +960°C  
according to EN 60695-2-11

Operating temperature 

Gel operating temperature:   
-60°C / +200°C

**IP69K** OFFICIALLY TESTED  
**IP68** OFFICIALLY TESTED  
**IMQ**

# Ready Box IP68

3 or 4 entrances junction boxes pre-filled with gel, complete with integrated terminal block and cable glands for 6 to 18 mm diameter cables and for 16/20/32 mm ducts/conduit.

- Ready to use, they can be installed in all environmental conditions
- Also suitable for wet or flooded environments
- Always re-enterable
- Pre-filled with gel. Non-toxic and non-classified as hazardous under CLP
- Pre-threaded entries for cable gland mounting
- Snap shut closure, does not require screws
- Wall or external ceiling fixing system
- Halogen free & UV resistant
- No shelf life

**Box pre-filled with non-toxic, safe gel. Nothing to pour, mix or cast!**



Ready, safe, quick and innovative





Ready Box IP68 - 120

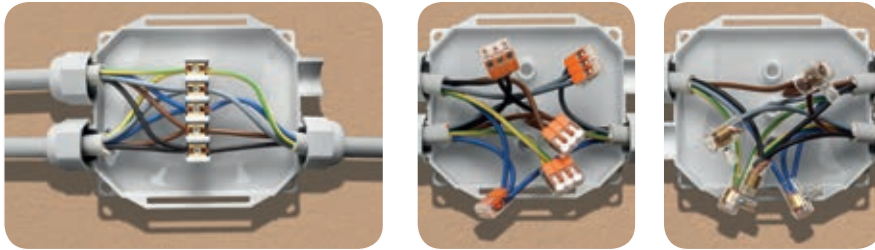

Ready Box IP68 - 90

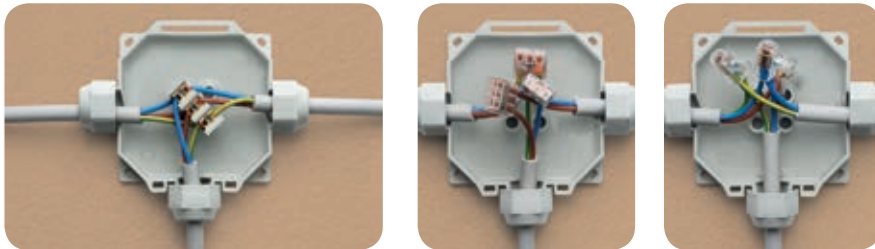

Thanks to its innovative design, unlike a standard box, there is no need to break through the walls of the box to insert the cable.

Also suitable for extra-flat lever connectors.

Also suitable for screw terminals.



Installation with free cables



Installation with cable gland duct

**Revolutionary!**

No additional accessories are required as it is equipped with connection block and glands M25 x 1,5

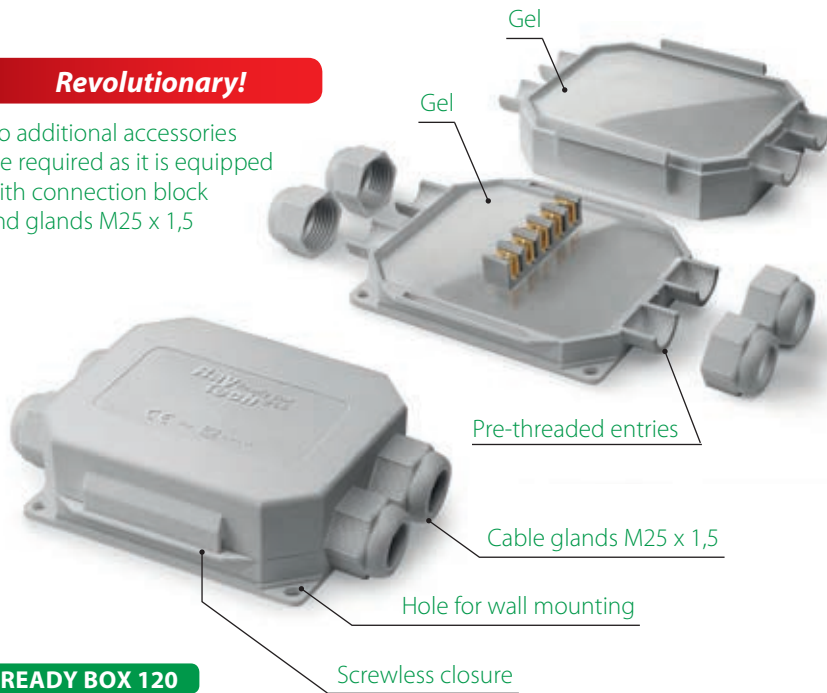

READY BOX 90

READY BOX 120

Product	Colour	Ø	Ø entrances with cable glands		Ø tubes (mm)	A x B x C (mm)
			min (mm)	max (mm)		
Ready Box IP68 90	●	3	6	18	16 / 20 / 32	90 x 90 x 45
Ready Box IP68 90/N	●					
Ready Box IP68 120	●	4	6	18	16 / 20 / 32	120 x 100 x 45
Ready Box IP68 120/N	●					







**Electrical performance:**  
CEI EN 50393  
as applicable

**Gel:** UL 94-HB

**Halogen free:**  
according to CEI EN 50267 2-2  
**Self-extinguishing and  
resistant to abnormal  
heat and fire:**  
Glow wire test a +960°C  
according to EN 60695-2-11

Operating temperature

Gel operating temperature:   
-60°C / +200°C

**IP69K**  
OFFICIALLY  
TESTED

**IP68**  
OFFICIALLY  
TESTED

**IMQ**

# Fox Box IP68

The 5 entrances jointing box with perimeter chamber pre-filled with gel to give the product the maximum lightness and capacity.

Kit includes accessories that maximise versatility and allow use with cables from 6 to 18 mm in diameter and with 16, 20 and 32 mm diameter cable conduits. The internal, gel-free compartment facilitates connection and any future disconnection with conductors. The gel, contained in the annular chamber of the box also contains, insulates and seals any armour continuity connections or shields.

- Functional, elegant design
- Ideal for exposed and safety systems and for video camera installation
- Ready for use
- Click and hook closure, does not require screws
- Ready and installable in all environmental conditions
- Also suitable for wet or flooded environments
- No shelf life
- Always re-enterable
- Wall or external ceiling fixing system
- Halogen free & UV resistant

Safe, fast, elegant, lightweight and versatile!



**PATENT PENDING**



1 Cutting the membrane (bottom and cover).

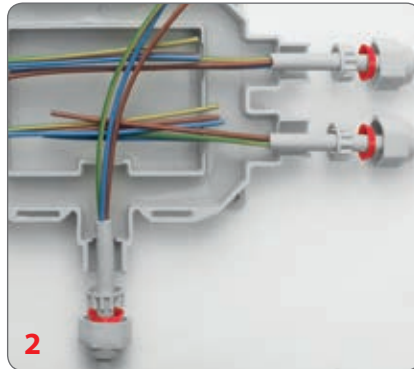

2 Gland and adapter pre-threading and cable positioning.

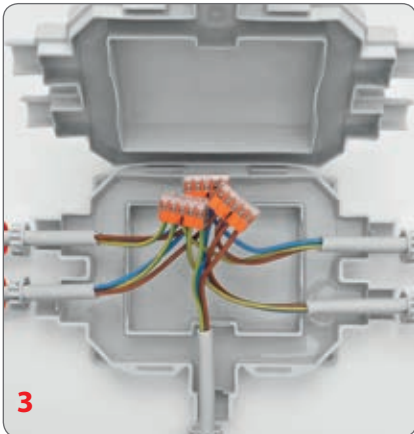

3 Conductor connection.



4 Nut closing and tightening.



On wall with cables



On wall with 3 conduit diameters

**Revolutionary!**

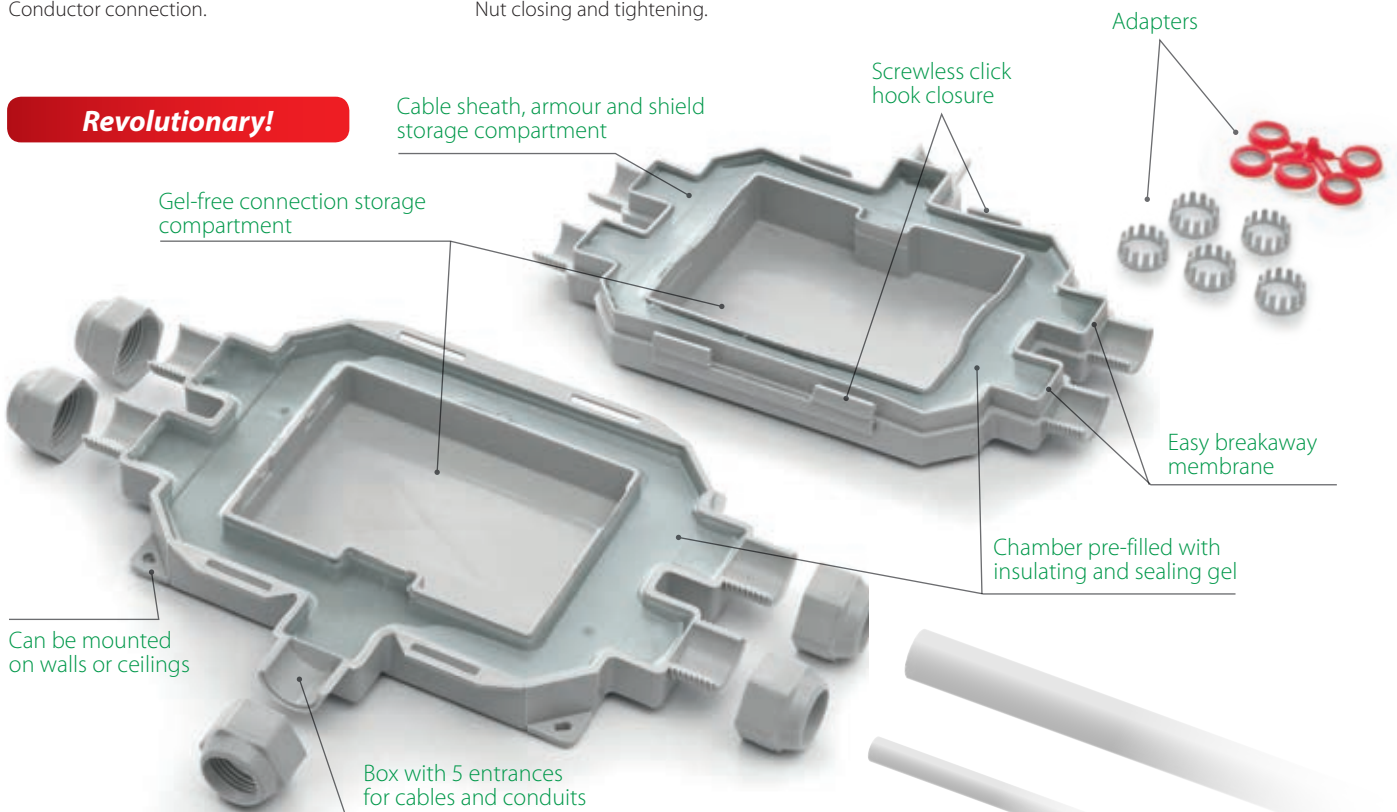

Product	Colour	N° of entrances	Ø entrances with cable glands min (mm)    max (mm)	Ø tubes (mm)	A x B x C (mm)
FOX BOX	●				
FOX BOX - N	●	5	6            18	16 / 20 / 32	210 x 155 x 45
FOX BOX - ARM	●				

Ø CABLES from 6 to 18 mm  
Ø CONDUITS 16 - 20 - 32 mm





PRE-FILLED WITH GEL  
for integrated connections



**Electrical performance:** CEI EN 50393  
(with testing under water head  
and water between the cable cores)  
Class 2 in accordance with CEI 64-8.

**No flame propagation:**  
CEI 20-35 • IEC 60332-1 HD405-1  
(as applicable)  
Low smoke and toxic and  
corrosive gas emissions

**Gel:** UL 94-HB 

**Mescola Involucro:** UL 94-V2

Operating temperature  90°

Installation temperature:  -40°C / +50°C

**IPX8** OFFICIALLY TESTED | **IMQ**

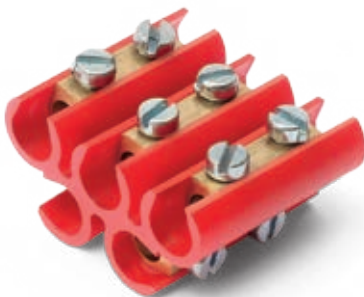

# Super Clik

Range of fast gel pre-filled straight or branch type joints for 0.6/1 kV multi core cables of up to 5 conductors.

The combination of the primary insulation in a cross-linked polymer gel and the highly robust insulating plastic case makes this a Class 2 joint defined by CEI 64-8. The joint has been tested in accordance with the main international specifications, with repeated flexing and torsion tests and immersion in water, it has been declared as conforming to the mechanical, electrical and sealing specifications required for plastic cable accessories. The joint and its components have an unlimited shelf life, they are chemically inert and therefore completely safe; the connections are re-entrable even after long working periods. Made of self-extinguishing components the joint is flame retardant. For cables at 90°C working temperature.

- Complete with isolated terminal blocks
- For straight and branch connections
- For all types of application, including submersible
- Re-accessible and with no shelf life
- Flame retardant
- Non toxic and safe



# SUPERCLIK





PRE-FILLED WITH GEL  
for integrated connections

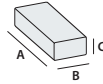

Product	Cable formation and conductor cross sections (n° x mm <sup>2</sup> )			Ø max cables (mm)	A x B x C (mm)
	Straight Connections In line	Branch connections T B			
Super Klik 0	3 x 1,5 - 6	3 x 1,5 - 4	3 x 1,5 - 2,5	14	95 x 43 x 28

T: Through cable - B: Branch cable

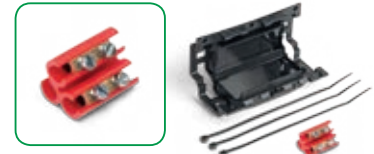

Product	Cable formation and conductor cross sections (n° x mm <sup>2</sup> )			Ø max cables (mm)	A x B x C (mm)
	Straight Connections In line	Branch connections T B			
Super Klik 1	2 x 1,5 - 6	2 x 4	2 x 2,5	20,5	150 x 56 x 30
	3 x 1,5 - 6	3 x 4	3 x 2,5		
	4 x 1,5 - 6	4 x 4	4 x 2,5		
	5 x 1,5 - 6	5 x 4	5 x 2,5		

T: Through cable - B: Branch cable

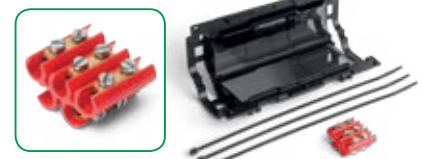

Product	Cable formation and conductor cross sections (n° x mm <sup>2</sup> )			Ø max cables (mm)	A x B x C (mm)
	Straight Connections In line	Branch connections T B			
Super Klik 2	2 x 4 - 16	2 x 10	2 x 6	30	220 x 85 x 46
	3 x 4 - 16	3 x 10	3 x 6		
	4 x 4 - 16	4 x 10	4 x 6		
	5 x 4 - 16	5 x 10	5 x 6		

T: Through cable - B: Branch cable

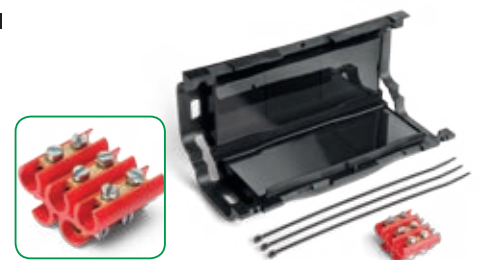

Product	Cable formation and conductor cross sections (n° x mm <sup>2</sup> )			Ø max cables (mm)	A x B x C (mm)
	Straight Connections In line	Branch connections T B			
Super Klik 3	-	2 x 4 - 25	2 x 1,5 - 16	30	220 x 85 x 46
		3 x 4 - 25	3 x 1,5 - 16		
		4 x 4 - 25	4 x 1,5 - 16		

T: Through cable - B: Branch cable

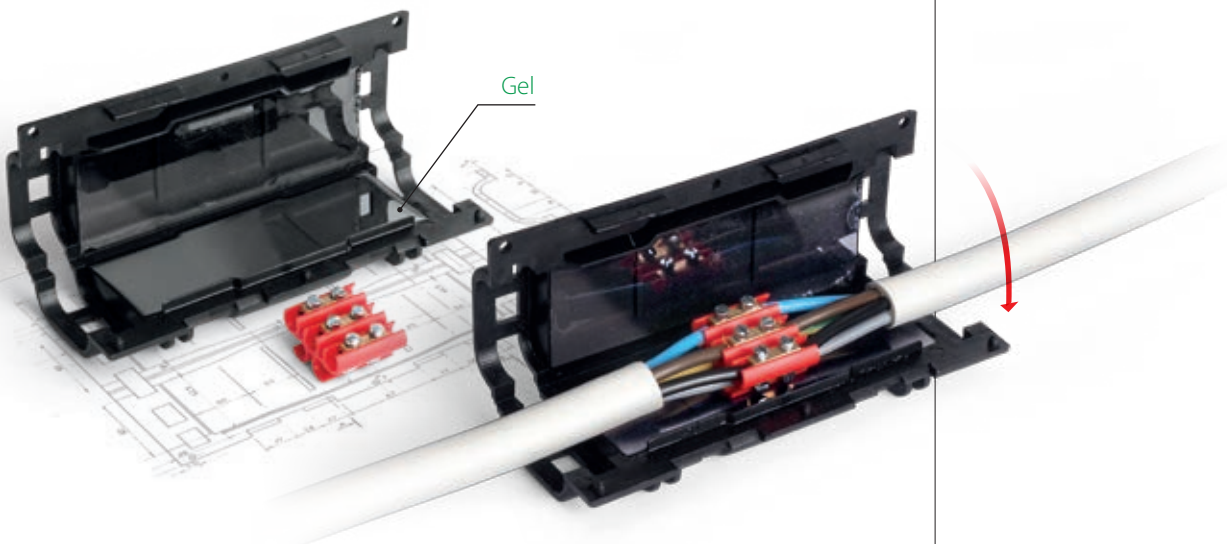
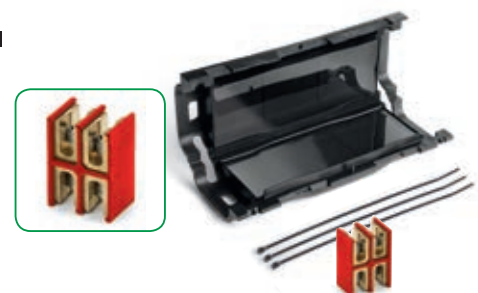



PRE-FILLED WITH GEL  
for integrated connections



**Electrical performance:** CEI EN 50393  
(with testing under water head  
and water between the cable cores)  
Class 2 in accordance with CEI 64-8.

**No flame propagation:**  
CEI 20-35 • IEC 60332-1 • HD405-1  
(as applicable)  
Low smoke and toxic and corrosive  
corrosive gas emissions

**Gel:** UL 94-HB 

**Casing mix:** UL 94-V2

**Degree of protection:** IP68

Operating temperature 

Installation temperature:  
-40°C / +50°C 

**IP68** | **IMQ**  
OFFICIALLY TESTED

**IP69K**  
OFFICIALLY TESTED

# Rapid Joint IP68

Radial closing gel pre-filled joint for extruded insulation cables up to 1 kV.

Primary insulation, consisting of a cross-linked polymer gel, and the exceptionally robust insulating plastic casing render Class 2 joints in accordance with the definitions contained in standard CEI 64-8. The joint has been tested in accordance with the main international specifications, with repeated flexing and torsion tests and immersion in water, and has been declared as conforming to the mechanical, electrical and sealing specifications required for plastic cable accessories. The joint and its components have an unlimited shelf life, are chemically inert and therefore completely safe. Conductor connections are re-enterable even after long periods of operation. Packaged with self-extinguishing material, flame retardant, for cables at 90°C working temperature. The radial closing system facilitates joint application, making them re-enterable only by means of a tool.

- For straight connections (in line)
- For multi core cables of up to 5 cores
- With suitable spacers
- For all types of application, including submersible
- Wide range of cable formations
- Re-enterable only by means of a tool
- Suitable for 3 core crossing
- Non-toxic, with no expiry date

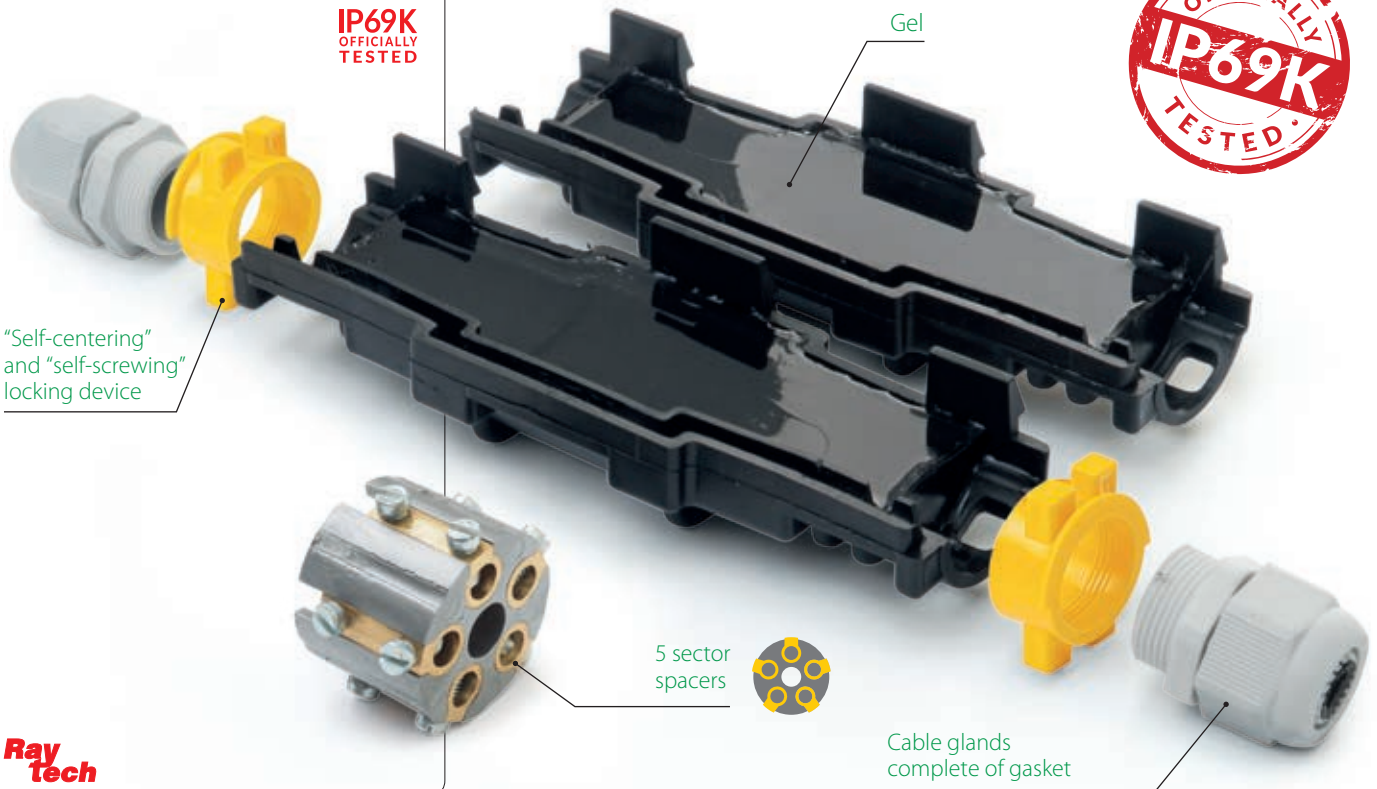



Product	Formation n°	Configuration IP68			Configuration IPX8		
		Section (mm²)	Ø cable (mm)	A x B (mm)	Section (mm²)	Ø cable (mm)	A x B (mm)
Rapid Joint L1,5-IP68	•	4 - 25			1,5 - 50		
	⊕	1,5 - 4			1,5 - 6		
	⊕	1,5 - 2,5	8 - 13	155 x 55	1,5 - 6	20,5	105 x 55
	⊕	1,5			1,5 - 6		
Rapid Joint L6-IP68	•	25 - 70			2,5 - 150		
	⊕	2,5 - 6			2,5 - 10		
	⊕	2,5 - 6	12 - 18	245 x 60	2,5 - 10	24	180 x 60
	⊕	2,5 - 6			2,5 - 10		
Rapid Joint L10-IP68	•	70 - 95			120 - 240		
	⊕	10			10 - 25		
	⊕	10	16 - 20	275 x 65	10 - 25	31	210 x 65
	⊕	10			10 - 25		
Rapid Joint L25-IP68	•	120 - 240			120 - 240		
	⊕	25			10 - 50		
	⊕	16 - 25	21 - 28	410 x 100	10 - 50	42	320 x 100
	⊕	16 - 25			10 - 50		

For single core cable: do not install the separator with screw connectors and connect with crimp connector.

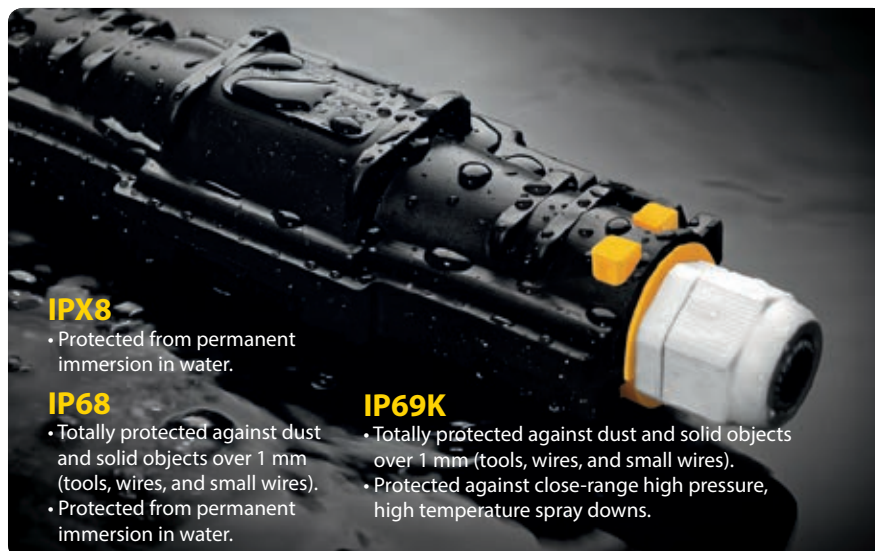
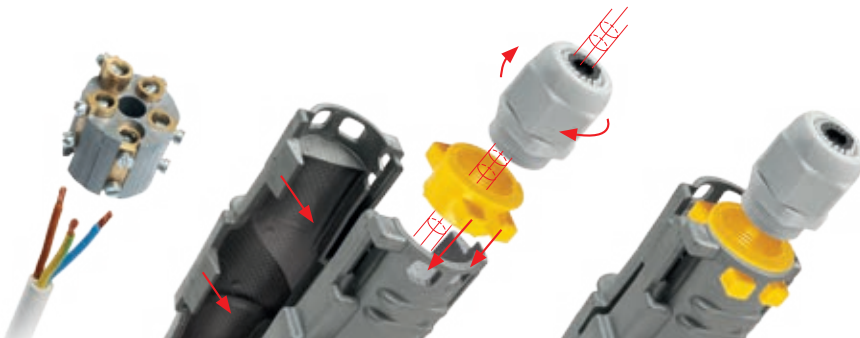





PRE-FILLED WITH GEL  
for integrated connections



**Electrical performance:**  
CEI EN 50393  
as applicable

**Gel:** UL 94-HB

Operating temperature

Installation temperature:   
-40°C / +50°C

Fully submersible

Can be used underground

**IP68**  
OFFICIALLY  
TESTED | **IMQ**

**IP69K**  
OFFICIALLY  
TESTED

# Mini Rapid Joint IP68

IP68 and IP69K joints for straight and branch connections, extremely compact and pre-filled with gel.

Extremely compact, ideal for lighting systems for gardens, steps and pedestrian crossings. Perfect for use in even small traps thanks to its very small overall dimensions. The cable glands supplied with the kit lock the joint on the cables.

- Provided with 2 (straight joints) or 3 (branch joints) cable glands to avoid accidental cable traction
- Complete with screw connectors
- Pre-filled with non-toxic, non-classified gel
- Extremely compact and ready to install
- Always re-enterable
- Halogen Free & UV resistant
- Ideal for straight or branch connections in lighting systems for gardens, steps and stairways, pedestrian crossings, etc.

RAPIDINO L4



RAPIDINO Y3



PRE-FILLED WITH GEL

for integrated connections

**Mini Rapid Joint IP68 L**

Product	Formation	Connector	Cable formation max (N° x mm²)	Ø cables min - max (mm)	Pieces / Pack	Diagram (mm)
Rapidino IP68 L2			2 x 2,5	6 - 10	3 pcs / Box	75 x 28 x 19
Rapidino IP68 L3			3 x 2,5	8 - 13	3 pcs / Box	80 x 36 x 23
Rapidino IP68 L4			4 x 4	10 - 16	1 pc / Box	125 x 43 x 35

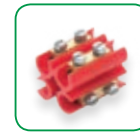

**Mini Rapid Joint IP68 Y**

Product	Formation	Connector	Through	Branch	Ø cables min - max (mm)	Pieces / Pack	Diagram (mm)
Rapidino IP68 Y1			1 x 4 1 x 2,5	1 x 1,5 1 x 2,5	6 - 10	2 pcs / Box	85 x 55 x 22
Rapidino IP68 Y3			3 x 4 3 x 2,5	3 x 1,5 3 x 2,5	8 - 13	1 pc / Box	110 x 72 x 25

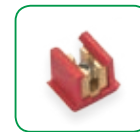



PRE-FILLED WITH GEL  
for integrated connections



**Electrical performance:**

CEI EN 50393  
(with testing under water head  
and water between the cable cores)  
Class 2 in accordance with CEI 64-8.

**No flame propagation:**

CEI 20-35 • IEC 60332-1 HD405-1  
(as applicable)  
Low smoke and toxic and  
corrosive gas emissions

**Gel:** UL 94-HB 

**Casing mix:** UL 94-V2

**Degree of protection:** IPX8

Operating temperature 

Installation temperature:   
-40°C / +50°C

**IPX8**  
OFFICIALLY  
TESTED **IMQ**

# King Joint

Range of fast gel pre-filled straight or branch type joints for 0.6/1 kV multi core cables of up to 5 conductors.

The primary insulation, consisting of a cross-linked polymer gel and extremely strong plastic insulating housing, make the Class 2, in accordance with the definitions contained in CEI Regulation 64-8. The joint, tested in accordance with the most important international specifications with repeated bending and twisting cycles and immersion in water, was found to comply with the mechanical, electrical and sealing requirements necessary for accessories for plastic cables. The joint and its components have no self life, are chemically inert and therefore completely safe; the conductor connections are re-accessible even after long operating periods. Packaged with self-extinguishing material, it is flame retardant. Suitable for cables with a temperature of +90°C.

- For multicore cables of up to 5 cores
- 5 sector spacers for proper centring of five-core connection
- Complete with screw connectors
- For straight and branch connections, including armoured cable
- For all types of application, including submersible
- Re-accessible and with no shelf life
- Flame retardant
- Non toxic and safe

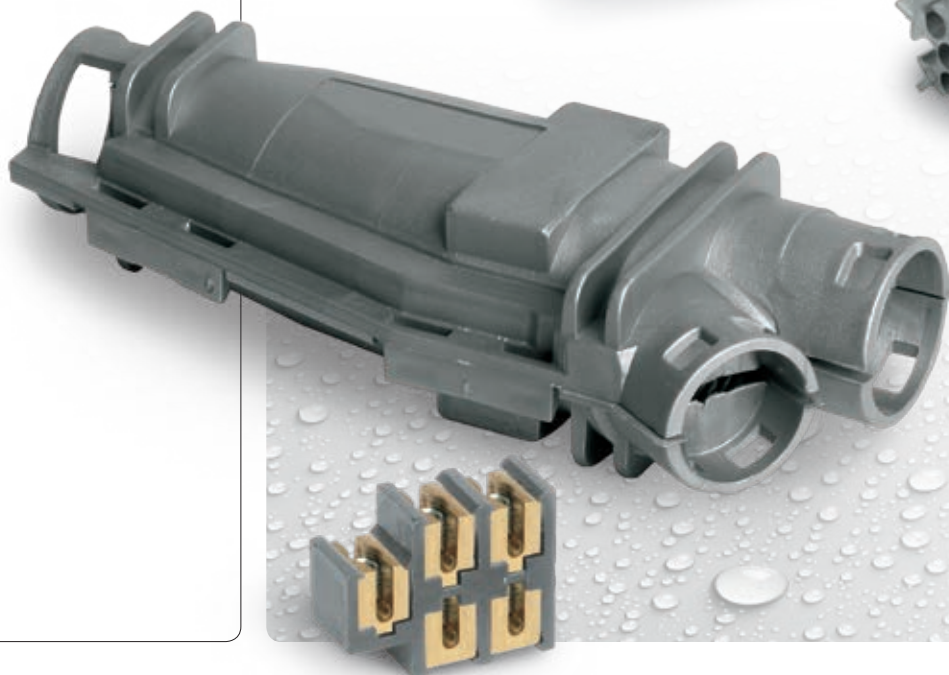
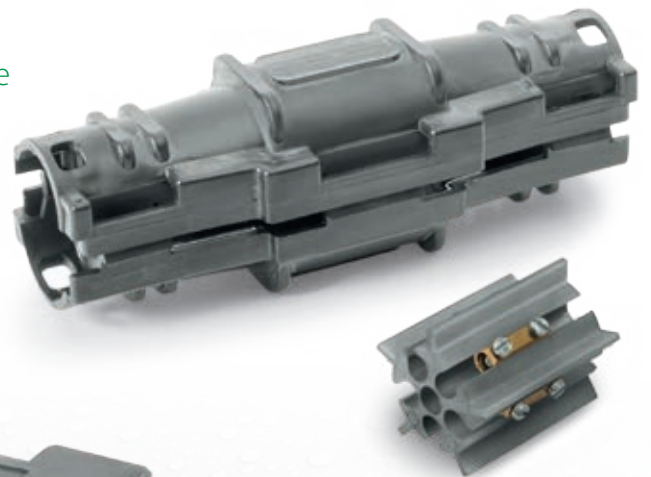





PRE-FILLED WITH GEL

for integrated connections

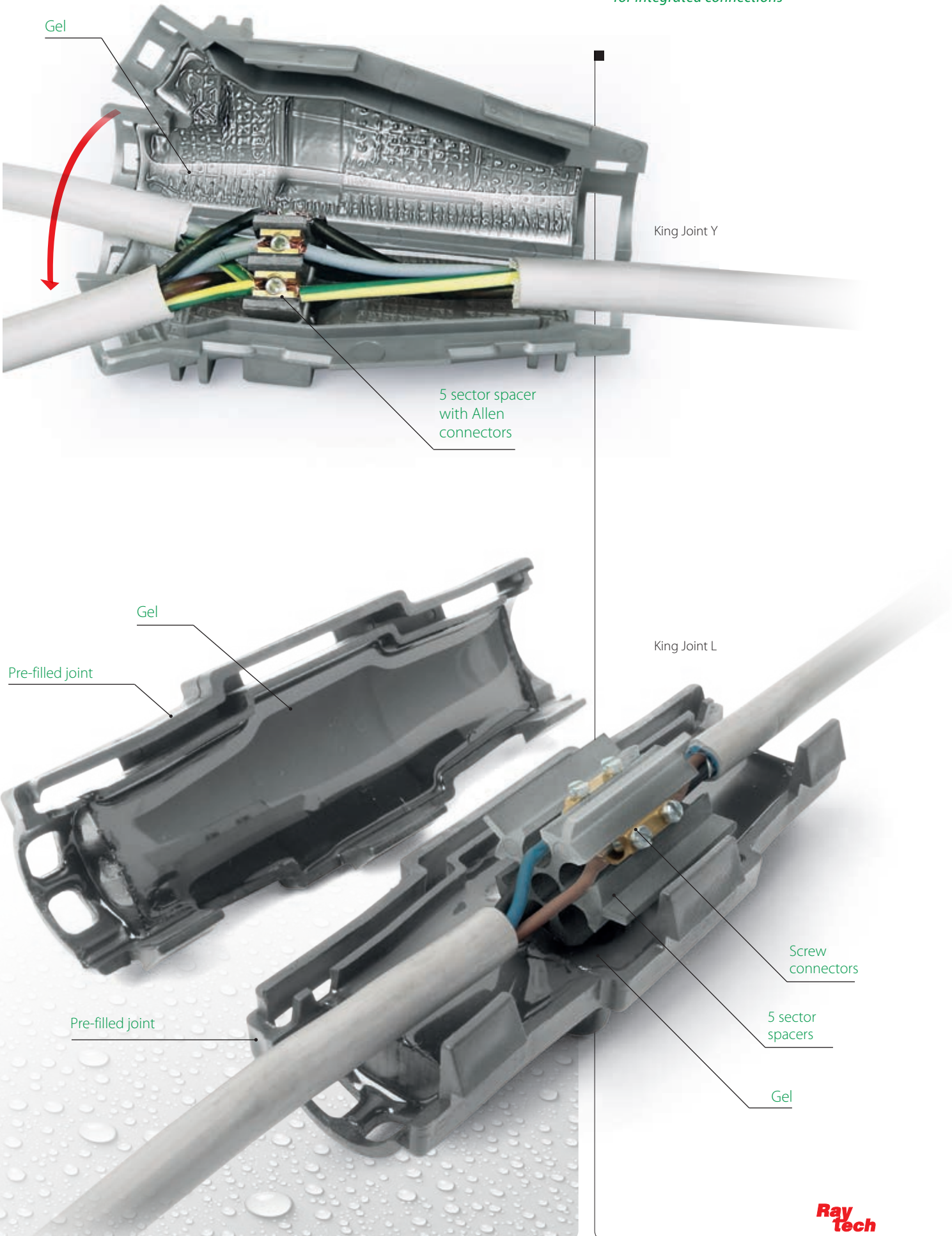



### King Joint L

Straight joints, including armoured cable.

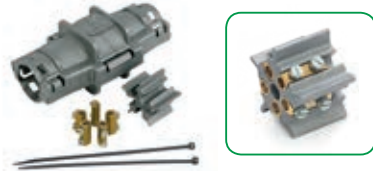
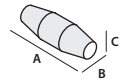

Product	LINE CONNECTIONS Cable formation and conductor cross sections (n° x mm <sup>2</sup> )	∅ max cables (mm)	Dimensions A x B x C (mm)
• King Joint 0 blister	2 x 1,5 - 6 3 x 1,5 - 6 4 x 1,5 - 6 5 x 1,5 - 6	20,5	105 x 55 x 55
• King Joint L6 box	2 x 1,5 - 6 3 x 1,5 - 6 4 x 1,5 - 6 5 x 1,5 - 6	20,5	105 x 55 x 55



Product	STRAIGHT CONNECTIONS Cable formation and conductor cross sections (n° x mm <sup>2</sup> )	∅ max cables (mm)	Dimensions A x B x C (mm)
• King Joint L10 • King Joint L10 - ARM	2 x 2,5 - 10 3 x 2,5 - 10 4 x 2,5 - 10 5 x 2,5 - 10	24	180 x 60 x 60



Product	STRAIGHT CONNECTIONS Cable formation and conductor cross sections (n° x mm <sup>2</sup> )	∅ max cables (mm)	Dimensions A x B x C (mm)
• King Joint L25 • King Joint L25 - ARM	2 x 10 - 25 3 x 10 - 25 4 x 10 - 25 5 x 10 - 25	31	210 x 65 x 65

ARM type joints complete with continuity device suitable for connection to **armoured wire or steel tape cables**.

#### Installation sequence King Joint L

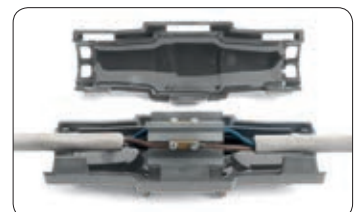



PRE-FILLED WITH GEL

for integrated connections

# King Joint Y

Branch joints, including armoured cable.

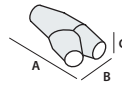

Product	BRANCH CONNECTIONS Cable formation and conductor cross sections (n° x mm²)		Ø max cables (mm)		Dimensions A x B x C (mm)
	T	B	T	B	
• King Joint Y6 • King Joint Y6 - ARM	2 x 1,5 - 6	2 x 1,5 - 4	22,5	18,5	138 x 60 x 37
	3 x 1,5 - 6	3 x 1,5 - 4			
	4 x 1,5 - 6	4 x 1,5 - 4			
	5 x 1,5 - 6	5 x 1,5 - 4			

T : Through cable - B : Branch cable



Product	BRANCH CONNECTIONS Cable formation and conductor cross sections (n° x mm²)		Ø max cables (mm)		Dimensions A x B x C (mm)
	T	B	T	B	
• King Joint Y16 • King Joint Y16 - ARM	2 x 4 - 16	2 x 1,5 - 4	26	18,5	194 x 74 x 43
	3 x 4 - 16	3 x 1,5 - 4			
	4 x 4 - 16*	4 x 1,5 - 4			
	5 x 4 - 16*	5 x 1,5 - 4			

T : Through cable - B : Branch cable

\* For armoured cables max conductor cross section 10 mm².



Product	BRANCH CONNECTIONS Cable formation and conductor cross sections (n° x mm²)		Ø max cables (mm)		Dimensions A x B x C (mm)
	T	B	T	B	
• King Joint Y35 • King Joint Y35 - ARM	2 x 10 - 35	2 x 1,5 - 6	36	26	290 x 105 x 51
	3 x 10 - 35	3 x 1,5 - 6			
	4 x 10 - 35*	4 x 1,5 - 6			

T : Through cable - B : Branch cable

\* For armoured cables max conductor cross section 25 mm².

ARM type joints complete with continuity device suitable for connection to **armoured wire or steel tape cables**.



## Installation sequence King Joint Y

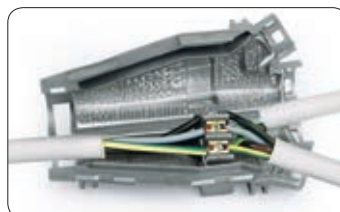
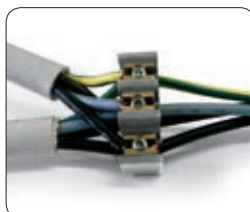





## JOINTS

PRE-FILLED WITH GEL  
for free connections

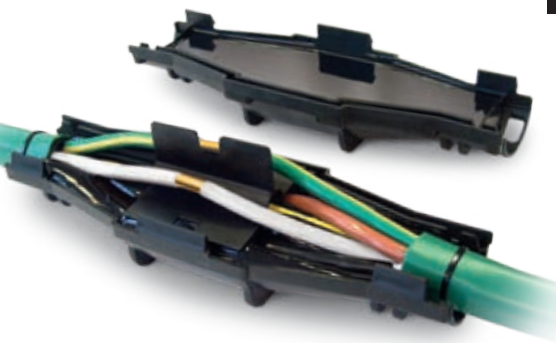

**Electrical performance:**  
CEI EN 50393 with connectors  
complying with EN 61238-1  
(with testing under water head  
and water between the cable cores)  
Class 2 in accordance with CEI 64-8.

## LV

# Rapid Joint

IPX8 straight joints for 0,6/1 kV extruded cable.

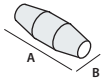

Product	Cable formation and conductor cross sections (n° x mm <sup>2</sup> )				With optical fibre separator 4x	Dimensions A x B (mm)
	1x	2x	3x	4x		
For <b>COPPER</b> cables						
Rapid Joint L6	1,5 - 50	1,5 - 10	1,5 - 10	1,5 - 6	-	105 x 55
Rapid Joint L10	2,5 - 150	2,5 - 25	2,5 - 16	2,5 - 16	-	180 x 60
Rapid Joint L25	120 - 240	6 - 50	6 - 35	4 - 35	-	210 x 65
Rapid Joint L95	185 - 400	35 - 95	25 - 70	25 - 70	16 - 50	320 x 100
For <b>ALUMINIUM</b> cables						
Rapid Joint L 25	120 - 240	16 - 35	10 - 25	10 - 25	-	210 x 65
Rapid Joint L 95	185 - 400	35 - 95	25 - 70	25 - 70	16 - 50	320 x 100

For screened or tape  
or wire armoured cables



Joint supplied with  
armour continuity device

# Rapid Joint S/ARM

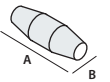

Product	Cable formation and conductor cross sections (n° x mm <sup>2</sup> )				With optical fibre separator 4x	Dimensions A x B (mm)
	1x	2x	3x	4x		
For <b>copper wire</b> SCREENED cables						
Rapid Joint L 10-S	2,5 - 120	2,5 - 10	2,5 - 10	2,5 - 10	-	180 x 60
Rapid Joint L 25-S	120 - 185	16 - 25	10 - 25	10 - 25	-	210 x 65
Rapid Joint L 95-S	240 - 400	35 - 95	25 - 70	25 - 70	16 - 50	320 x 100
For <b>copper tape</b> ARMoured cables						
Rapid Joint L 10-ARM	2,5 - 10	2,5 - 10	2,5 - 10	-	-	180 x 60
Rapid Joint L 25-ARM	16 - 25	10 - 25	10 - 25	-	-	210 x 65
Rapid Joint L 95-ARM	35 - 95	25 - 70	25 - 70	-	16 - 50	320 x 100

For signalling and control  
cables



# Rapid Joint LS

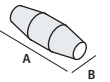

Product	Conductor sections cross (mm <sup>2</sup> )	Cable formation (n° conductors)								Dimensions A x B (mm)		
		5x	7x	10x	12x	16x	19x	24x	40x		75x	100x
Rapid Joint-LS1	1,5 2,5	•	•	•	•	•	•					180 x 60
Rapid Joint-LS2	1,5 2,5					•	•	•	•			210 x 65
Rapid Joint-LS3	1,5 2,5							•	•	•	•	320 x 100

Straight joints for  
telephone cables



# Rapid Joint T

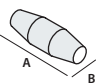

UNscreened Product	SCREENED Product	N° pairs for conductor cross sections (n° x mm <sup>2</sup> )	Dimensions A x B (mm)
Rapid Joint-T26	Rapid Joint-TS26	(1 - 26) x (0,5 - 0,6)	180 x 60
Rapid Joint-T61	Rapid Joint-TS61	(30 + 1 - 64 + 1) x (0,5 - 0,6)	210 x 65
Rapid Joint-T101	Rapid Joint-TS101	(60 + 1 - 100 + 1) x (0,5 - 0,6)	320 x 100



PRE-FILLED WITH GEL

for free connections

# Clík Fire

Straight or branch joint pre-filled with gel, for multi core cables up to 4 cores.



Straight or branch multi core joints for 0.6/1 kV extruded cables.

Product	Cable formation and conductor cross sections (n° x mm <sup>2</sup> )		Ø max cables (mm)		Dimensions A x B x C (mm)
	Through or straight	1 or 2 branch cables	Through or straight	Branch	
CLIK 0 Fire	1 x 2,5 - 50	1 x 1,5 - 10	16	10	95 x 43 x 28
	2 x 2,5 - 6	2 x 1,5			
CLIK 1 Fire	1 x 6 - 95	1 x 1,5 - 35	20,5	15	150 x 56 x 30
	2 x 1,5 - 16	2 x 1,5 - 6			
	3 x 1,5 - 10	3 x 1,5 - 6			
	4 x 1,5 - 10	4 x 1,5 - 4			
CLIK 2 Fire	1 x 50 - 185	1 x 16 - 185	30	29	220 x 85 x 46
	2 x 10 - 35	2 x 1,5 - 35			
	3 x 6 - 35	3 x 1,5 - 35			
	4 x 6 - 35	4 x 1,5 - 16			

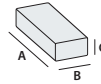
**Electrical performance:**

CEI EN 50393 with connectors complying with EN 61238-1 (with testing under water head and water between the cable cores) Class 2 in accordance with CEI 64-8.

**No flame propagation:**

CEI 20-35 • IEC 60332-1 • HD405-1 (as applicable)

Gel: UL 94-HB 

Casing mix: UL 94-V2

Degree of protection: IPX8

 Operating temperature

 Installation temperature: -40°C / +50°C



RINA



Branch joints with 30° output for 0.6/1 kV extruded cables.

Product	Cable formation and conductor cross sections (n° x mm <sup>2</sup> )		Ø max cables (mm)		Dimensions A x B x C (mm)
	Through	Branch	Through	Branch	
CLIK 2000 Fire	1 x 2,5 - 25	1 x 1,5 - 16	14	12,5	75 x 40 x 21
	1 x 6 - 95	1 x 1,5 - 70			
CLIK 2001 Fire	2 x 1,5 - 16	2 x 1,5 - 10	22,5	18,5	138 x 60 x 37
	3 x 2,5 - 16	3 x 1,5 - 10			
	4 x 2,5 - 10	4 x 1,5 - 6			
	1 x 50 - 150	1 x 1,5 - 70			
CLIK 2002 Fire	2 x 1,5 - 25	2 x 1,5 - 10	26	18,5	194 x 74 x 43
	3 x 4 - 25	3 x 1,5 - 10			
	4 x 4 - 16	4 x 1,5 - 6			
	1 x 150 - 240	1 x 50 - 120			
CLIK 2003 Fire	2 x 16 - 50	2 x 10 - 25	36	26	290 x 105 x 51
	3 x 16 - 50	3 x 10 - 25			
	4 x 16 - 50	4 x 6 - 16			
	1 x 150 - 240	1 x 50 - 120			

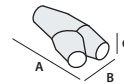

Sections evaluated on the base extruded 0,6 1 kV cable.

**Raytech**



## Approvals

## Electrical performance:

CEI EN 50393 • CEI 20-33 • IP 0033 (A2A)

## No flame propagation:

CEI 20-35 • IEC 60332-1 HD405-1  
A2A certified (as applicable)Gel: UL 94-HB 

Casing mix: UL 94-V2

Degree of protection: IPX8

Operating temperature Installation temperature:   
-40°C / +50°C

## Clik Fire - A2A

Main line branch joint for parallel type public lighting systems.

Branch joints from main to main cable, from main to pole rise, from overhead line to pole equipment, from pre-assembled cable to pole equipment, of a type certified by Azienda Elettrica Milanese (A2A, ex AEM). Accessories are complete with mantel-type, pre-insulated Allen screw connectors and, for installations with traps, with the specific protection monitor plate. Joints are non-toxic, with no shelf life and re-enterable.

Product	Approval code	Branch type	Through cable (n° x mm <sup>2</sup> )	Branch cable (n° x mm <sup>2</sup> )
CLIK 2 Fire Dor/Palo	E 27.012	Main / Pole	RG7R 2 x 1 x 16	FG7OR 2 x 2,5
CLIK 1 Fire Dor/Dor	E 27.013	Main / Main	RG7R 4 x 1 x 16	RG7R 4 x 1 x 16
CLIK 1 Fire Aer/Dap	E 27.014	Overhead line / Equipment	UG7R 2 x 1 x 16	FG7R 2 x 1 x 4
CLIK 2 Fire Prec/Dap	E 27.015	Pre-assembled / Equipment	RE4E4X 2 x 1 x 10	FG7OR 2 x 2,5



## Approvals

## Electrical performance:

CEI EN 50393 • CEI 20-33 • IP 0033 (A2A)

## No flame propagation:

CEI 20-35 • IEC 60332-1 HD405-1  
A2A certified (as applicable)Gel: UL 94-HB 

Casing mix: UL 94-V2

Degree of protection: IPX8

Operating temperature Installation temperature:   
-40°C / +50°C

## Clik Fire - A2A (Fuse)

Branch joint from main to pole rise, with protection fuse.

Branch joints from main to pole rise complete with disconnectable fuse holder and fuse with signal indicating intervention. Accessories are complete with mantel-type, pre-insulated Allen screw connectors and, for installations with traps, with the specific protection monitor plate. Joints are non-toxic, with no shelf life and re-enterable and flame retardant.

Product	Fuse inserted	Branch type	Through cable (n° x mm <sup>2</sup> )	Branch cable (n° x mm <sup>2</sup> )
CLIK 2 Fire Dor/Palo Fuse	16 A	Main / Pole	RG7R 4 x 1 x 16	FG7OR 2 x 2,5







# Magic Power Joint

Straight or branch joint with Magic Power Gel for extruded insulation cables up to 1 kV.

Joints for extruded cables F(R)G7OR 0.6/1 kV. Easy installation, composed of two anti-fracture plastic shells, to be filled with non-toxic quick cross linking bicomponent insulation such as Magic Power Gel. Suitable for installation in traps, channels or directly underground or under water. Non-toxic, safe, light and re-enterable. Thanks to the softness of the insulation, they are able to absorb external shock without cracking or fracturing. The extreme stickiness of the insulation together with its softness allow it to transmit water pressure for installation even at high depths.

## RE-ENTERABLE



## REMOVABLE



## INSPECTIONABLE



## REUSABLE



- Re-enterable and inspectable joint
- Insulated with **Magic Power Gel**, the innovative self-amalgamating gel
- For installations even in harsh conditions and high depths!
- Extremely adherent and tight sealing
- Non-toxic and safe
- No shelf life

Magic Power Joint Y

Magic Power Joint L



### Electrical performance:

CEI EN 50393 with connectors complying with EN 61238-1 (with testing under water head and water between the cable cores) Class 2 in accordance with CEI 64-8.

**Gel:** UL 94-HB

**Degree of protection:** IP68

**90°** Operating temperature

**Installation temperature:** -15°C / +55°C



In 15 minutes, the gel is cross-linked and **Magic Power Joint** is ready!

**Ray  
tech**



## Magic Power Joint L

Straight joint for 0.6/1 kV extruded cables.

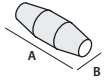

Product	Cable formation and conductor cross sections (n° x mm <sup>2</sup> )				Dimensions A x B (mm)
	1x	2x	3x	4x	
Magic P Joint L10	2,5 - 50	1,5 - 10	1,5 - 10	1,5 - 10 *	180 x 50
Magic P Joint L25	16 - 150	4 - 25	4 - 25	2,5 - 25	215 x 55
Magic P Joint L35	16 - 185	16 - 35	16 - 35	16 - 35	232 x 70
Magic P Joint L50	50 - 300	16 - 50	16 - 50	16 - 50	266 x 72
Magic P Joint L95	120 - 400	25 - 95	25 - 95	25 - 95	330 x 75
Magic P Joint L120	240 - 500	70 - 120	70 - 120	50 - 120	365 x 95
Magic P Joint L240	400 - 1000	120 - 300	120 - 240	120 - 240	510 x 120
Magic P Joint L300	630 - 2000	240 - 400	240 - 300	240 - 300	760 x 180

Product	1x	2x	3x	4x	(mm)
Magic P Joint L50	16 - 150	16 - 25	16 - 25	16 - 25	266 x 72
Magic P Joint L120	185 - 400	25 - 95	25 - 95	25 - 95	365 x 95
Magic P Joint L240	400 - 630	95 - 185	95 - 185	95 - 185	510 x 120
Magic P Joint L300	630 - 2000	185 - 300	185 - 300	185 - 300	760 x 180

\* Magic Power Joint 10 suggested for cable diameters smaller than 16 mm.



## Magic Power Joint Y

Branch joint for 0.6/1 kV extruded cables.

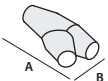

Product	Cable formation and conductor cross sections (n° x mm <sup>2</sup> )								Dimensions A x B (mm)
	1x		2x		3x		4x		
	T	B	T	B	T	B	T	B	
Magic P Joint Y6	4 - 50	4 - 50	4 - 10	4 - 10	2,5 - 6	2,5 - 6	2,5 - 6	2,5 - 6	180 x 90
Magic P Joint Y25	50 - 150	50 - 150	10 - 25	10 - 25	6 - 25	6 - 16	6 - 25	6 - 10	220 x 105
Magic P Joint Y95	120 - 400	95 - 240	25 - 95	16 - 50	25 - 95	16 - 50	25 - 95	10 - 50	315 x 115
Magic P Joint Y240*	240 - 630	240 - 630	95 - 240	50 - 240	95 - 240	50 - 240	95 - 240	50 - 240	600 x 285

T: Through - B: Branch  
\* also for aluminium cables.



## Magic Power Joint L-S

Straight joint for 0.6/1 kV screened extruded cables.

Product	Cable formation and conductor cross sections (n° x mm <sup>2</sup> )				Dimensions A x B (mm)
	1x	2x	3x	4x	
Magic P Joint L10-S	2,5 - 50	1,5 - 10	1,5 - 6	1,5 - 6	180 x 50
Magic P Joint L25-S	16 - 120	4 - 25	4 - 16	2,5 - 16	215 x 55
Magic P Joint L35-S	16 - 185	16 - 35	16 - 25	16 - 25	232 x 70
Magic P Joint L50-S	50 - 240	16 - 50	16 - 50	16 - 50	266 x 72
Magic P Joint L120-S	240 - 500	70 - 120	70 - 120	50 - 95	365 x 95
Magic P Joint L240-S	400 - 1000	120 - 300	120 - 185	120 - 185	510 x 120
Magic P Joint L300-S	630 - 2000	240 - 400	240 - 300	240 - 300	760 x 180

Product	Cable formation and conductor cross sections (n° x mm <sup>2</sup> )				Dimensions A x B (mm)
	1x	2x	3x	4x	
Magic P Joint L50-S	16 - 150	16 - 25	16 - 25	16 - 25	266 x 72
Magic P Joint L120-S	185 - 400	25 - 95	25 - 95	25 - 95	365 x 95
Magic P Joint L240-S	400 - 630	95 - 185	95 - 185	95 - 185	510 x 120
Magic P Joint L300-S	630 - 2000	185 - 300	185 - 300	185 - 300	760 x 180

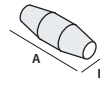

## Magic Power Joint Y-S

Branch joint for 0.6/1 kV screened extruded cables.

Product	Cable formation and conductor cross sections (n° x mm <sup>2</sup> )								Dimensions A x B (mm)
	1x		2x		3x		4x		
	T	B	T	B	T	B	T	B	
Magic P Joint Y6-S	4 - 35	4 - 35	4 - 10	4 - 10	2,5 - 6	2,5 - 6	2,5 - 6	2,5 - 6	180 x 90
Magic P Joint Y25-S	35 - 120	35 - 120	10 - 25	10 - 25	6 - 16	6 - 16	6 - 16	6 - 10	220 x 105
Magic P Joint Y95-S	95 - 300	70 - 150	25 - 95	16 - 50	16 - 70	16 - 35	16 - 50	10 - 35	315 x 115
Magic P Joint Y240-S*	240 - 630	150 - 630	95 - 240	50 - 240	70 - 240	35 - 240	50 - 240	35 - 240	600 x 285

T: Through - B: Branch  
\* also for aluminium cables.

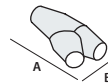





## Magic Power Joint L-ARM

Straight joint for 0,6/1 kV extruded cables with tape, wire or plate armouring.

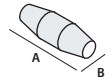

Product	Cable formation and conductor cross sections (n° x mm <sup>2</sup> )			Dimensions A x B (mm)
	2x	3x	4x	
Magic P Joint L10-ARM	1,5 - 10	1,5 - 6	1,5 - 6	180 x 50
Magic P Joint L25-ARM	4 - 25	4 - 16	2,5 - 16	215 x 55
Magic P Joint L35-ARM	16 - 35	16 - 25	16 - 25	232 x 70
Magic P Joint L50-ARM	16 - 50	16 - 50	16 - 50	266 x 72
Magic P Joint L120-ARM	70 - 120	70 - 120	50 - 95	365 x 95
Magic P Joint L240-ARM	120 - 300	120 - 185	120 - 185	510 x 120
Magic P Joint L300-ARM	240 - 400	240 - 300	240 - 300	760 x 180

Product	Cable formation and conductor cross sections (n° x mm <sup>2</sup> )			Dimensions A x B (mm)
	2x	3x	4x	
Magic P Joint L50-ARM	16 - 25	16 - 25	16 - 25	266 x 72
Magic P Joint L120-ARM	25 - 95	25 - 95	25 - 95	365 x 95
Magic P Joint L240-ARM	95 - 185	95 - 185	95 - 185	510 x 120
Magic P Joint L300-ARM	185 - 300	185 - 300	185 - 300	760 x 180



## Magic Power Joint Y-ARM

Branch joint for 0,6/1 kV extruded cables with tape, wire or plate armouring.

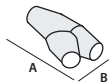

Product	Cable formation and conductor cross sections (n° x mm <sup>2</sup> )						Dimensions A x B (mm)
	2x		3x		4x		
	T	B	T	B	T	B	
Magic P Joint Y6-ARM-F	4 - 10	4 - 10	2,5 - 6	2,5 - 6	2,5 - 6	2,5 - 6	180 x 90
Magic P Joint Y25-ARM-F	10 - 25	10 - 25	6 - 16	6 - 16	6 - 16	6 - 10	220 x 105
Magic P Joint Y95-ARM-F	25 - 70	16 - 50	25 - 70	16 - 35	25 - 50	10 - 35	315 x 115
Magic P Joint Y240-ARM-F*	70 - 240	50 - 240	70 - 240	35 - 240	50 - 240	35 - 240	600 x 285

Product	Cable formation and conductor cross sections (n° x mm <sup>2</sup> )						Dimensions A x B (mm)
	2x		3x		4x		
	T	B	T	B	T	B	
Magic P Joint Y6-ARM	4 - 10	4 - 10	2,5 - 6	2,5 - 6	2,5 - 6	2,5 - 6	180 x 90
Magic P Joint Y25-ARM	10 - 25	10 - 25	6 - 16	6 - 16	6 - 16	6 - 10	220 x 105
Magic P Joint Y95-ARM	25 - 70	16 - 50	25 - 70	16 - 35	25 - 50	10 - 35	315 x 115
Magic P Joint Y240-ARM*	70 - 240	50 - 240	70 - 240	35 - 240	50 - 240	35 - 240	600 x 285

T: Through - B: Branch  
\* also for aluminium cables.



## Magic Power Joint-SL

Straight joint for signaling and control multi core extruded 0,6/1 kV cables.

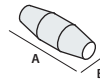

Product	Conductor cross sections (mm <sup>2</sup> )	Cable formation (n° conductors)											Dimensions A x B (mm)				
		5x	7x	10x	12x	16x	19x	24x	40x	75x	100x	250x		500x			
Magic P Joint SL11	1,5 2,5	•	•	•	•	•											180 x 50
Magic P Joint SL12	1,5 2,5			•	•	•	•	•									215 x 55
Magic P Joint SL13	1,5 2,5					•	•	•	•								266 x 72
Magic P Joint SL14	1,5 2,5									•	•						330 x 75
Magic P Joint SL15	1,5 2,5										•	•	•				365 x 95
Magic P Joint SL16	1,5 2,5											•	•	•			510 x 120
Magic P Joint SL17	1,5 2,5												•	•	•		760 x 180



## Magic Power Joint-SY

Branch joint for signaling and control multi core extruded 0,6/1 kV cables.

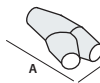

Product	Conductor cross sections (mm <sup>2</sup> )	Cable formation (n° conductors)											Dimensions A x B (mm)				
		5x	7x	10x	12x	16x	19x	24x	40x	75x	100x	250x		500x			
Magic P Joint SY1	1,5 2,5	•	•	•	•	•	•										180 x 90
Magic P Joint SY2	1,5 2,5					•	•	•									220 x 105
Magic P Joint SY3	1,5 2,5									•	•	•	•				315 x 115
Magic P Joint SY4	1,5 2,5											•	•	•	•	•	600 x 285



## Magic Power Joint-T e TS

Straight joint for telephone cables.

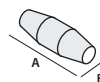

UNSCREENED Product	SCREENED Product	N° pairs per conductor cross sections (n° x mm <sup>2</sup> )	Dimensions A x B (mm)
Magic P Joint T16	Magic P Joint TS16	1 - 16 x 0,5 - 0,6	180 x 50
Magic P Joint T25	Magic P Joint TS25	16 - 25 x 0,5 - 0,6	215 x 55
Magic P Joint T35	Magic P Joint TS35	25 - 35 x 0,5 - 0,6	266 x 72
Magic P Joint T40	Magic P Joint TS40	35 - 40 x 0,5 - 0,6	330 x 75
Magic P Joint T64	Magic P Joint TS64	40 - 64 x 0,5 - 0,6	365 x 95
Magic P Joint T500	Magic P Joint TS500	60 - 500 x 0,5 - 0,6	510 x 120
Magic P Joint T1000	Magic P Joint TS1000	450 - 1000 x 0,5 - 0,6	760 x 180





# Magic Joint

Straight or branch joint with Magic Gel filling gel for extruded insulation cables up to 1 kV.

Joints for extruded cables F(R)G7OR 0.6/1 kV. Easy installation, composed of two anti-fracture plastic shells, to be filled with non-toxic quick cross linking bicomponent insulation with no shelf life, Magic Gel type. Suitable for installation in traps, channels or directly underground or under water. Non-toxic, safe, light and re-enterable. Thanks to the softness of the insulation, they are able to absorb external shock without cracking or fracturing. The extreme stickiness of the insulation, together with its softness allow it to transmit water pressure for installation even at high depths. Thanks to the materials used, joints are completely non-toxic, safe, re-enterable even after long periods of operation.

**Electrical performance:**

CEI EN 50393 with connectors complying with EN 61238-1 (with testing under water head and water between the cable cores) Class 2 in accordance with CEI 64-8.

**Gel:** UL 94-HB 

**Degree of protection:** IP68

Operating temperature 

Installation temperature:  -15°C / +45°C

- Quick cross linking gel, (only 10 minutes at 23°C)
- Extremely adherent and tight sealing
- Non-toxic and safe
- No shelf life







## Installation sequence

Prepare the joint.



Slip off the separator.



Mix for a minute.



Pour within a minute.



After 10 minutes, Magic joint is ready.





## Magic Joint

Straight joint for 0.6/1 kV extruded cables.

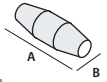

Product	Cable formation and conductor cross sections (n° x mm <sup>2</sup> )				Dimensions (mm)
	1x	2x	3x	4x	
Magic Joint 4	1,5 - 25	1,5 - 4	1,5 - 4	1,5 - 4	160 x 45
Magic Joint 10	2,5 - 50	1,5 - 10	1,5 - 10	1,5 - 10 *	180 x 50
Magic Joint 25	16 - 150	4 - 25	4 - 25	2,5 - 25	215 x 55
Magic Joint 35	16 - 185	16 - 35	16 - 35	16 - 35	232 x 70
Magic Joint 50	50 - 300	16 - 50	16 - 50	16 - 50	266 x 72
Magic Joint 95	120 - 400	25 - 95	25 - 95	25 - 95	330 x 75
Magic Joint 120	240 - 500	70 - 120	70 - 120	50 - 120	365 x 95
Magic Joint 240	400 - 1000	120 - 300	120 - 240	120 - 240	510 x 120
Magic Joint 300	630 - 2000	240 - 400	240 - 300	240 - 300	760 x 180

Product	1x	2x	3x	4x	(mm)
Magic Joint 50	16 - 150	16 - 25	16 - 25	16 - 25	266 x 72
Magic Joint 120	185 - 400	25 - 95	25 - 95	25 - 95	365 x 95
Magic Joint 240	400 - 630	95 - 185	95 - 185	95 - 185	510 x 120
Magic Joint 300	630 - 2000	185 - 300	185 - 300	185 - 300	760 x 180

\* Magic Joint 10 suggested for cable diameters smaller than 16 mm.



## Magic Joint Y

Branch joint for 0.6/1 kV extruded cables.

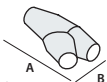

Product	Cable formation and conductor cross sections (n° x mm <sup>2</sup> )								Dimensions A x B (mm)
	1x		2x		3x		4x		
	T	B	T	B	T	B	T	B	
Magic Joint Y 6	4 - 50	4 - 50	4 - 10	4 - 10	2,5 - 6	2,5 - 6	2,5 - 6	2,5 - 6	180 x 90
Magic Joint Y25	50 - 150	50 - 150	10 - 25	10 - 25	6 - 25	6 - 16	6 - 25	6 - 10	220 x 105
Magic Joint Y95	120 - 400	95 - 240	25 - 95	16 - 50	25 - 95	16 - 50	25 - 95	10 - 50	315 x 115
Magic Joint Y240*	240 - 630	240 - 630	95 - 240	50 - 240	95 - 240	50 - 240	95 - 240	50 - 240	600 x 285

T : Through - B : Branch

\* also for aluminium cables.



# Magic Joint Fire

Straight or branch joint with quick cross linking bi-component cast gel for 0.6/1 kV flame retardant cables.

Magic line joints are now also available in the flame retardant version, MAGIC JOINT-FIRE, particularly suitable for installations in places most at risk of fire: available in straight and branch types, they maintain the electrical and sealing characteristics of the traditional Magic line described above, but add a self-extinguishing property, together with their low smoke and toxic gas development and absence of halogen, as required by main international legislation.

- Flame retardant
- Quick cross linking gel
- Extremely adherent and tight sealing
- For 0.6/1 kV extruded cables
- Non-toxic and safe
- No shelf life



## Installation sequence



### Electrical performance:

CEI EN 50393 with connectors complying with EN 61238-1 (with testing under water head and water between the cable cores)  
Class 2 in accordance with CEI 64-8.

### No flame propagation:

CEI 20-35 • IEC 60332-1 HD405-1 (as applicable)  
Low smoke and toxic and corrosive gas emissions

Gel: UL 94-HB 

Casing mix: UL 94-V2

Degree of protection: IP68

 Operating temperature

 Installation temperature: -10°C / +45°C





## Magic Joint Fire

Straight joint for 0.6/1 kV extruded cables.

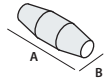

For <b>COPPER</b> cables	Cable formation and conductor cross sections (n° x mm <sup>2</sup> )				Dimensions A x B (mm)
	1x	2x	3x	4x	
<b>Product</b>					
Magic Joint 4-Fire	1,5 - 25	1,5 - 4	1,5 - 4	1,5 - 4	160 x 45
Magic Joint 10-Fire	2,5 - 50	1,5 - 10	1,5 - 10	1,5 - 10 *	180 x 50
Magic Joint 25-Fire	16 - 150	4 - 25	4 - 25	2,5 - 25	215 x 55
Magic Joint 35-Fire	16 - 185	16 - 35	16 - 35	16 - 35	232 x 70
Magic Joint 50-Fire	50 - 300	16 - 50	16 - 50	16 - 50	266 x 72
Magic Joint 95-Fire	120 - 400	25 - 95	25 - 95	25 - 95	330 x 75
Magic Joint 120-Fire	240 - 500	70 - 120	70 - 120	50 - 120	365 x 95
Magic Joint 240-Fire	400 - 1000	120 - 300	120 - 240	120 - 240	510 x 120
Magic Joint 300-Fire	630 - 2000	240 - 400	240 - 300	240 - 300	760 x 180

For <b>ALUMINIUM</b> cables	1x	2x	3x	4x	(mm)
Magic Joint 50-Fire	16 - 150	16 - 25	16 - 25	16 - 25	266 x 72
Magic Joint 120-Fire	185 - 400	25 - 95	25 - 95	25 - 95	365 x 95
Magic Joint 240-Fire	400 - 630	95 - 185	95 - 185	95 - 185	510 x 120
Magic Joint 300-Fire	630 - 2000	185 - 300	185 - 300	185 - 300	760 x 180



## Magic Joint Y Fire

Branch joint for 0.6/1 kV extruded cables.

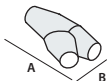

For <b>COPPER</b> cables	Cable formation and conductor cross sections (n° x mm <sup>2</sup> )								Dimensions A x B (mm)
	1x		2x		3x		4x		
<b>Product</b>	T	B	T	B	T	B	T	B	
Magic Joint Y 6-Fire	4 - 50	4 - 50	4 - 10	4 - 10	2,5 - 6	2,5 - 6	2,5 - 6	2,5 - 6	180 x 90
Magic Joint Y25-Fire	50 - 150	50 - 150	10 - 25	10 - 25	6 - 25	6 - 16	6 - 25	6 - 10	220 x 105
Magic Joint Y95-Fire	120 - 400	95 - 240	25 - 95	16 - 50	25 - 95	16 - 50	25 - 95	10 - 50	315 x 115

T: Through - B: Branch



## Magic Joint S Fire

Straight joint for signalling and control.

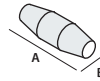

Product	Conductor cross sections (mm <sup>2</sup> )	Cable formation (n° conductors)											Dimensions A x B (mm)				
		5x	7x	10x	12x	16x	19x	24x	40x	75x	100x	250x		500x			
Magic Joint S11 Fire	1,5 2,5	•	•	•	•	•											180 x 50
Magic Joint S12 Fire	1,5 2,5			•	•	•	•	•									215 x 55
Magic Joint S13 Fire	1,5 2,5					•	•	•	•								266 x 72
Magic Joint S14 Fire	1,5 2,5							•	•								330 x 75
Magic Joint S15 Fire	1,5 2,5								•	•							365 x 95
Magic Joint S16 Fire	1,5 2,5									•	•						510 x 120
Magic Joint S17 Fire	1,5 2,5										•	•					760 x 180



## Magic Joint SY Fire

Branch joint for signalling and control.

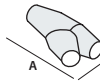

Product	Conductor cross sections (mm <sup>2</sup> )	Cable formation (n° conductors)									Dimensions A x B (mm)						
		5x	7x	10x	12x	16x	19x	24x	40x	75x							
Magic Joint SY1 Fire	1,5 2,5	•	•	•	•	•	•										180 x 90
Magic Joint SY2 Fire	1,5 2,5			•	•	•	•	•									220 x 105
Magic Joint SY3 Fire	1,5 2,5							•	•	•	•						315 x 115



## Magic Joint T Fire

Straight joint for telephone cable.

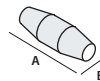

UNSCREENED	SCREENED	N° pairs per conductor cross sections (n° x mm <sup>2</sup> )	Dimensions A x B (mm)
Product	Product		
Magic Joint T16-Fire	Magic Joint TS16-Fire	1 - 16 x 0,5 - 0,6	180 x 50
Magic Joint T25-Fire	Magic Joint TS25-Fire	16 - 25 x 0,5 - 0,6	215 x 55
Magic Joint T35-Fire	Magic Joint TS35-Fire	25 - 35 x 0,5 - 0,6	266 x 72
Magic Joint T40-Fire	Magic Joint TS40-Fire	35 - 40 x 0,5 - 0,6	330 x 75
Magic Joint T64-Fire	Magic Joint TS64-Fire	40 - 64 x 0,5 - 0,6	365 x 95
Magic Joint T500-Fire	Magic Joint TS500-Fire	60 - 500 x 0,5 - 0,6	510 x 120
Magic Joint T1000-Fire	Magic Joint TS1000-Fire	450 - 1000 x 0,5 - 0,6	760 x 180





# Rubber Joint

Straight or branch joint with bicomponent cast quick cross linking rubber insulation for 0.6/1 kW cables.

**Electrical performance:**  
CEI EN 50393 with connectors complying with EN 61238-1 (with testing under water head and water between the cable cores) Class 2 in accordance with CEI 64-8.

**Degree of protection:** IP68

Operating temperature  90°

Installation temperature:  -15°C / +45°C

With new Magic Rubber insulation, designed and developed by Raytech for 0.6/1 kV cables. A new line of accessories with extremely high mechanical characteristics, as well as dielectric and thermal properties. The new line is re-enterable even after long periods of operation, is free of exotherm during cross linking, is extremely fast-acting and has no shelf life. Significant also for its very low emission of toxic and corrosive gases and fumes. Thanks to its exceptional mechanical characteristics, these joints are especially suitable for placement in traps or channels where there is the possibility of handling even after the laying of cables or, however, in cases of heavy abrasion, or mechanical stress within the normal parameters of installation and operation.

- Quick cross linking rubber (only 15 minutes)
- Very high mechanical and elastic characteristics
- For 0.6/1 kV extruded cables
- No shelf life



Installation sequence







## Rubber Joint

Straight joint for 0.6/1 kV extruded cables.

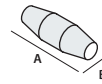

Product	Cable formation and conductor cross sections (n° x mm <sup>2</sup> )				Dimensions A x B (mm)
	1x	2x	3x	4x	
Rubber Joint 4	1,5 - 25	1,5 - 4	1,5 - 4	1,5 - 4	160 x 45
Rubber Joint 10	2,5 - 50	1,5 - 10	1,5 - 10	1,5 - 10 *	180 x 50
Rubber Joint 25	16 - 150	4 - 25	4 - 25	2,5 - 25	215 x 55
Rubber Joint 35	16 - 185	16 - 35	16 - 35	16 - 35	232 x 70
Rubber Joint 50	50 - 300	16 - 50	16 - 50	16 - 50	266 x 72
Rubber Joint 95	120 - 400	25 - 95	25 - 95	25 - 95	330 x 75
Rubber Joint 120	240 - 500	70 - 120	70 - 120	50 - 120	365 x 95
Rubber Joint 240	400 - 1000	120 - 300	120 - 240	120 - 240	510 x 120
Rubber Joint 300	630 - 2000	240 - 400	240 - 300	240 - 300	760 x 180



\* Rubber Joint 10 suggerito per diametri di cavo non superiori a 16 mm.

## Rubber Joint Y

Branch joint for 0.6/1 kV extruded cables.

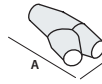

Product	Cable formation and conductor cross sections (n° x mm <sup>2</sup> )								Dimensions A x B (mm)
	1x		2x		3x		4x		
	T	B	T	B	T	B	T	B	
Rubber Joint Y6	4 - 50	4 - 50	4 - 10	4 - 10	2,5 - 6	2,5 - 6	2,5 - 6	2,5 - 6	180 x 90
Rubber Joint Y25	50 - 150	50 - 150	10 - 25	10 - 25	6 - 25	6 - 16	6 - 25	6 - 10	220 x 105
Rubber Joint Y95	120 - 400	95 - 240	25 - 95	16 - 50	25 - 95	16 - 50	25 - 95	10 - 50	315 x 115
Rubber Joint Y240*	240 - 630	240 - 630	95 - 240	95 - 240	95 - 240	95 - 240	95 - 240	50 - 240	600 x 285

T: Through - B: Branch

\* also for aluminium cables.





# Raycast

**Electrical performance:**  
CEI EN 50393 with connectors  
complying with EN 61238-1  
(with testing under water head  
and water between the cable cores)  
Class 2 in accordance with CEI 64-8.

Operating temperature  90°

Installation temperature:  0°C / +45°C

Straight or branch joint with bicomponent epoxy resin insulation for 0.6/1 kV cables.

Straight or branch joints for 0.6/1 kV extruded cables: easily installed, composed of two anti-fracture plastic shells, to be filled with bicomponent epoxy resin such as Rayresin. For installation in traps, channels or directly underground.



### Installation sequence



# Raycast L

Straight joint for 0.6/1 kV extruded cables.

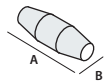

Product	Cable formation and conductor cross sections (n° x mm <sup>2</sup> )				Dimensions A x B (mm)
	1x	2x	3x	4x	
Raycast L10	2,5 - 50	1,5 - 10	1,5 - 10	1,5 - 10 *	180 x 50
Raycast L16/25	16 - 150	4 - 25	4 - 25	2,5 - 25	215 x 55
Raycast L35	16 - 185	16 - 35	16 - 35	16 - 35	232 x 70
Raycast L50	50 - 300	16 - 50	16 - 50	16 - 50	266 x 72
Raycast L95	120 - 400	25 - 95	25 - 95	25 - 95	330 x 75
Raycast L120	240 - 500	70 - 120	70 - 120	50 - 120	365 x 95
Raycast L240	400 - 1000	120 - 300	120 - 240	120 - 240	510 x 120

Product	1x	2x	3x	4x	(mm)
Raycast L50	16 - 150	16 - 25	16 - 25	16 - 25	266 x 72
Raycast L120	185 - 400	25 - 95	25 - 95	25 - 95	365 x 95
Raycast L240	400 - 630	95 - 185	95 - 185	95 - 185	510 x 120

\* Raycast L10 is suggested for cable diameters not exceeding 16 mm.



## Raycast D

Branch joint for 0.6/1 kV extruded cable with 30° output.

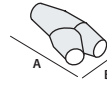

Product	Cable formation and conductor cross sections (n° x mm <sup>2</sup> )								Dimensions A x B (mm)
	1x		2x		3x		4x		
	T	B	T	B	T	B	T	B	
Raycast D6	4 - 50	4 - 50	4 - 10	4 - 10	2,5 - 6	2,5 - 6	2,5 - 6	2,5 - 6	180 x 90
Raycast D16/D25	50 - 150	50 - 150	10 - 25	10 - 25	6 - 25	6 - 16	6 - 25	6 - 10	220 x 105
Raycast D95	120 - 400	95 - 240	25 - 95	16 - 50	25 - 95	16 - 50	25 - 95	10 - 50	315 x 115

T: Through - B: Branch



## Raycast L-S

Straight joint for 0.6/1 kV screened extruded cables.

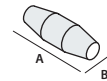

Product	Cable formation and conductor cross sections (n° x mm <sup>2</sup> )				Dimensions A x B (mm)
	1x	2x	3x	4x	
Raycast L10-S	2,5 - 50	1,5 - 10	1,5 - 6	1,5 - 6	180 x 50
Raycast L25-S	16 - 120	4 - 25	4 - 16	2,5 - 16	215 x 55
Raycast L35-S	16 - 185	16 - 35	16 - 25	16 - 25	232 x 70
Raycast L50-S	50 - 240	16 - 50	16 - 50	16 - 50	266 x 72
Raycast L120-S	240 - 500	70 - 120	70 - 120	50 - 95	365 x 95
Raycast L240-S	400 - 1000	120 - 300	120 - 185	120 - 185	510 x 120

Product	1x	2x	3x	4x	(mm)
Raycast L50-S	16 - 150	16 - 25	16 - 25	16 - 25	266 x 72
Raycast L120-S	185 - 400	25 - 95	25 - 95	25 - 95	365 x 95
Raycast L240-S	400 - 630	95 - 185	95 - 185	95 - 185	510 x 120

For ALUMINIUM cables



## Raycast D-S

Branch joint for 0.6/1 kV screened extruded cables.

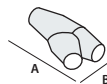

Product	Cable formation and conductor cross sections (n° x mm <sup>2</sup> )								Dimensions A x B (mm)
	1x		2x		3x		4x		
	T	B	T	B	T	B	T	B	
Raycast D6-S	4 - 35	4 - 35	4 - 10	4 - 10	2,5 - 6	1,5 - 6	2,5 - 6	2,5 - 6	180 x 90
Raycast D25-S	35 - 120	35 - 120	10 - 25	10 - 25	6 - 16	6 - 16	6 - 16	6 - 10	220 x 105
Raycast D95-S	95 - 300	70 - 150	25 - 95	16 - 50	16 - 70	16 - 35	16 - 50	10 - 35	315 x 115

T: Through - B: Branch

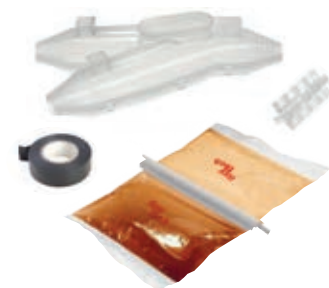





## Raycast L-ARM

Straight joint for tape, wire or plate armoured cables.

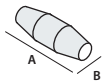

Product	Cable formation and conductor cross sections (n° x mm <sup>2</sup> )			Dimensions A x B (mm)
	2x	3x	4x	
Raycast L10-ARM	1,5 - 10	1,5 - 6	1,5 - 6	180 x 50
Raycast L25-ARM	4 - 25	4 - 16	2,5 - 16	215 x 55
Raycast L35-ARM	16 - 35	16 - 25	16 - 25	232 x 70
Raycast L50-ARM	16 - 50	16 - 50	16 - 50	266 x 72
Raycast L120-ARM	70 - 120	70 - 120	50 - 95	365 x 95
Raycast L240-ARM	120 - 300	120 - 185	120 - 185	510 x 120

  

Product	Cable formation and conductor cross sections (n° x mm <sup>2</sup> )			Dimensions A x B (mm)
	2x	3x	4x	
Raycast L50-ARM	16 - 25	16 - 25	16 - 25	266 x 72
Raycast L120-ARM	25 - 95	25 - 95	25 - 95	365 x 95
Raycast L240-ARM	95 - 185	95 - 185	95 - 185	510 x 120



## Raycast D-ARM

Branch joint for tape, wire or plate armoured cable.

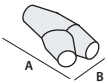

Product	Cable formation and conductor cross sections (n° x mm <sup>2</sup> )						Dimensions A x B (mm)
	2x		3x		4x		
	T	B	T	B	T	B	
Raycast D6-ARM-F	4 - 10	4 - 10	2,5 - 6	2,5 - 6	2,5 - 6	2,5 - 6	180 x 90
Raycast D16-ARM-F	10 - 25	10 - 25	6 - 16	6 - 16	6 - 16	6 - 10	220 x 105
Raycast D95-ARM-F	25 - 70	16 - 50	25 - 70	16 - 35	25 - 50	10 - 35	315 x 115

Product	Cable formation and conductor cross sections (n° x mm <sup>2</sup> )						Dimensions A x B (mm)
	2x		3x		4x		
	T	B	T	B	T	B	
Raycast D6-ARM	4 - 10	4 - 10	2,5 - 6	2,5 - 6	2,5 - 6	2,5 - 6	180 x 90
Raycast D16-ARM	10 - 25	10 - 25	6 - 16	6 - 16	6 - 16	6 - 10	220 x 105
Raycast D95-ARM	25 - 70	16 - 50	25 - 70	16 - 35	25 - 50	10 - 35	315 x 115

T: Through - B: Branch



## Raycast LPS

Straight joint for very deep submersible pumps.

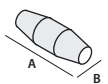

Product	Cable formation and conductor cross sections (n° x mm <sup>2</sup> )				Dimensions A x B (mm)
	1x	2x	3x	4x	
Raycast LPS10	2,5 - 50	1,5 - 10	1,5 - 10	1,5 - 10	180 x 50
Raycast LPS25	16 - 150	4 - 25	4 - 25	2,5 - 25	215 x 55
Raycast LPS95	120 - 400	25 - 95	25 - 95	25 - 95	330 x 75
Raycast LPS240	400 - 1000	120 - 300	120 - 240	120 - 240	510 x 120



## Raycast DPS

Branch joint for very deep submersible pumps.

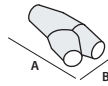

For <b>COPPER</b> cables	Cable formation and conductor cross sections (n° x mm <sup>2</sup> )								Dimensions A x B (mm)
	1x		2x		3x		4x		
Product	T	B	T	B	T	B	T	B	
Raycast DPS6	4-50	4-50	4-10	4-10	2,5-6	2,5-6	2,5-6	2,5-6	180 x 90
Raycast DPS25	50-150	50-150	10-25	10-25	6-25	6-16	6-16	6-10	220 x 105
Raycast DPS95	120-400	95-240	25-95	16-50	25-95	16-50	25-95	10-50	315 x 115

T: Through - B: Branch

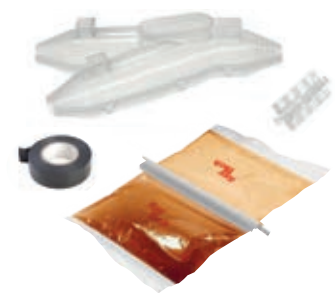

## Raycast SL

Straight joint for signalling and control.

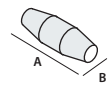

Product	Conductor cross sections (mm <sup>2</sup> )	Cable formation (n° conductors)											Dimensions A x B (mm)		
		5x	7x	10x	12x	16x	19x	24x	40x	75x	100x	250x			
Raycast SL11	1,5 2,5	•	•	•	•	•									180 x 50
Raycast SL12	1,5 2,5			•	•	•	•								215 x 55
Raycast SL13	1,5 2,5					•	•	•	•						266 x 72
Raycast SL14	1,5 2,5							•	•	•					330 x 75
Raycast SL15	1,5 2,5								•	•	•				365 x 95
Raycast SL16	1,5 2,5									•	•	•			510 x 120



## Raycast SD

Branch joint for signalling and control.

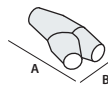

Product	Conductor cross sections (mm <sup>2</sup> )	Cable formation (n° conductors)											Dimensions A x B (mm)		
		5x	7x	10x	12x	16x	19x	24x	40x	75x					
Raycast SD1	1,5 2,5	•	•	•	•	•	•								180 x 90
Raycast SD2	1,5 2,5			•	•	•	•	•							220 x 105
Raycast SD3	1,5 2,5							•	•	•	•				315 x 115



## Raycast TL e TSL

Straight joint for telephone cable.

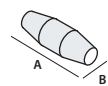

UNSCREENED	SCREENED	N° pairs per conductor cross sections (n° x mm <sup>2</sup> )	Dimensions A x B (mm)
Product	Product		
Raycast TL16	Raycast TSL16	1 - 16 x 0,5 - 0,6	180 x 50
Raycast TL25	Raycast TSL25	16 - 25 x 0,5 - 0,6	215 x 55
Raycast TL35	Raycast TSL35	25 - 35 x 0,5 - 0,6	266 x 72
Raycast TL40	Raycast TSL40	35 - 40 x 0,5 - 0,6	330 x 75
Raycast TL64	Raycast TSL64	40 - 64 x 0,5 - 0,6	365 x 95
Raycast TL500	Raycast TSL500	60 - 500 x 0,5 - 0,6	510 x 120





# Wonder Joint

Straight or branch injectable joint using Wonder Fluid, single component insulating gel. Quick to use and can be installed at any temperature.

Joint equipped with injection valve; insert the cartridge in the gun, connect the nozzle stably on the valve and inject the gel until completely filled. The valve on the container prevents insulation from leaking out, ensuring perfect cleaning and reliability. Can be installed without any special tools: only requires a regular silicone gun.

- Joints insulated with **Wonder Fluid**, fluid, single-component, gel
- Clean installation, re-enterable and inspectable
- Container provided with no-return valve
- Immediately energizable
- Even suitable for high depths
- Non-toxic, with no expiry date



**Electrical performance:**  
 CEI EN 50393 with connectors  
 complying with EN 61238-1  
 (with testing under water head  
 and water between the cable cores)  
 Class 2 in accordance with CEI 64-8.

**Gel:** UL 94-HB

**Degree of protection:** IP68

Operating temperature **90°**

Installation temperature: **-50°C / +60°C**

## Installation sequence





## Wonder Joint L

Straight joint with injected gel insulation for 0.6/1 kV extruded cables.

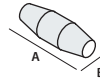

Product	Cable formation and conductor cross sections (n° x mm <sup>2</sup> )				Dimensions A x B (mm)
	1x	2x	3x	4x	
Wonder Joint L4	1,5 - 25	1,5 - 4	1,5 - 4	1,5 - 4	160 x 45
Wonder Joint L10	2,5 - 50	1,5 - 10	1,5 - 10	1,5 - 10	180 x 50
Wonder Joint L25	16 - 150	4 - 25	4 - 25	2,5 - 25	215 x 55



## Wonder Joint Y

Branch joint with injected gel insulation for 0.6/1 kV extruded cables.

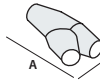

Product	Cable formation and conductor cross sections (n° x mm <sup>2</sup> )								Dimensions A x B (mm)
	1x		2x		3x		4x		
	T	B	T	B	T	B	T	B	
Wonder Joint Y6	4 - 50	4 - 50	4 - 10	4 - 10	2,5 - 6	2,5 - 6	2,5 - 6	2,5 - 6	180 x 90
Wonder Joint Y25	50 - 150	50 - 150	10 - 25	10 - 25	6 - 25	6 - 16	6 - 25	6 - 10	220 x 105

T: Through - B: Branch





# SYSTEM PLUS

Range of straight and branch joints with cast or injection filling, equipped with **screw or Allen screw connection system** for extruded insulation cables up to 1 kV.

Five-core separator for linear junction connectors

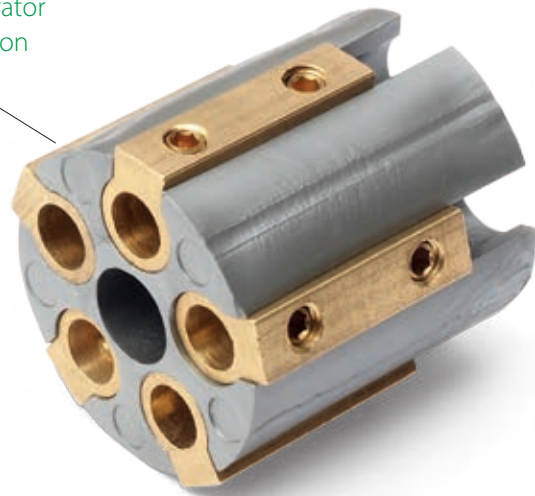

## Wonder Joint System Plus

- Straight or branch joint with valve
- Integrated connection system
- *Wonder Fluid* cartridge



## Magic Power Joint System Plus

- Straight or branch "Y" joint or "T" branch joint
- Integrated connection system
- Single bottle of *Magic Power Gel*

With four-core separator for "T" branch joint





Five-core separator  
with connectors  
for "Y" branch joints

Four-core separator  
with connectors  
for "T" branch joints



**Electrical performance:**

CEI EN 50393 • CEI 20-33  
(with testing under water head and water  
between the cable cores)

**Degree of protection:** IP68

## Magic Joint System Plus

- Straight or branch "Y" joint or "T" branch joint
- Integrated connection system
- Single dose bag of *Magic Gel*

With four-core separator for "T" branch joint

## Raycast System Plus

- Straight or branch "Y" joint or "T" branch joint
- Integrated connection system
- Single dose bag of *Ray Resin*

With four-core separator for "T" branch joint







## Wonder Joint System Plus L

Straight joint with **injected gel**

Five-core spacer + screw connectors.

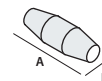

Product	Cable formation and conductor cross sections (n° x mm <sup>2</sup> )				Dimensions A x B (mm)
	2x	3x	4x	5x	
Wonder Joint SP L6	1,5 - 6	1,5 - 6	1,5 - 6	1,5 - 6	180 x 50
Wonder Joint SP L25	4 - 25	4 - 25	4 - 25	4 - 25	215 x 55



## Wonder Joint System Plus Y

Branch joint with **injected gel**

Five-core spacer + screw connectors.

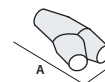

Product	Cable formation and conductor cross sections (n° x mm <sup>2</sup> )								Dimensions A x B (mm)
	2x		3x		4x		5x		
	T	B	T	B	T	B	T	B	
Wonder Joint SP Y6	1,5 - 6	1,5 - 4	1,5 - 6	1,5 - 4	1,5 - 6	1,5 - 4	1,5 - 6	1,5 - 4	180 x 90
Wonder Joint SP Y16	4 - 16	1,5 - 4	4 - 16	1,5 - 4	4 - 16	1,5 - 4	4 - 16	1,5 - 4	220 x 105

T: Through - B: Branch

- Joints insulated with **Wonder Fluid**, single component gel
- Clean installation, re-enterable and inspectable
- Containers provided with no-return valve
- Even suitable for high depths
- Non-toxic and no shelf life
- For 0.6/1 kV extruded cables

Operating temperature **90°**

Installation temperature:  
-50°C / +60°C



## Magic Power Joint System Plus L

Straight joint with **cast gel**

Five-core spacer + screw connectors.

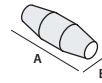

Product	Cable formation and conductor cross sections (n° x mm <sup>2</sup> )				Dimensions A x B (mm)
	2x	3x	4x	5x	
Magic P Joint SP L6	1,5 - 6	1,5 - 6	1,5 - 6	1,5 - 6	180 x 50
Magic P Joint SP L16	4 - 16	4 - 16	4 - 16	4 - 16	215 x 55
Magic P Joint SP L25	4 - 25	4 - 25	4 - 25	4 - 25	215 x 65



## Magic Power Joint System Plus Y

Y branch joint with **cast gel**

Five-core spacer + screw connectors.

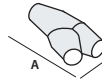

Product	Cable formation and conductor cross sections (n° x mm <sup>2</sup> )								Dimensions A x B (mm)
	2x		3x		4x		5x		
	T	B	T	B	T	B	T	B	
Magic P Joint SP Y6	1,5-6	1,5-4	1,5-6	1,5-4	1,5-6	1,5-4	1,5-6	1,5-4	180 x 90
Magic P Joint SP Y16	4-16	1,5-4	4-16	1,5-4	4-16	1,5-4	4-16	1,5-4	220 x 105

T: Through - B: Branch



## Magic Power Joint System Plus T

T branch joint with **cast gel**

Four-core spacer + screw connectors.

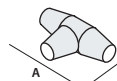

Product	Cable formation and conductor cross sections (n° x mm <sup>2</sup> )						Dimensions A x B (mm)
	2x		3x		4x		
	T	B	T	B	T	B	
Magic P Joint SP T35	6 - 35	1,5 - 10	6 - 35	1,5 - 10	6 - 35	1,5 - 10	305 x 155

T: Through - B: Branch



- Joints insulated with **Magic Power Gel**, the only agglomerating gel
- Re-enterable, removable, inspectable
- For installations even in harsh conditions and high depths
- Extremely adherent and tight sealing
- Non-toxic and no shelf life
- For 0.6/1 kV extruded cables

90° Operating temperature

Installation temperature:  
-15°C / +55°C

**Ray  
tech**



## Magic Joint System Plus L

Straight joint with **cast gel**  
Five-core spacer + screw connectors.

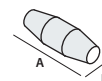

For <b>COPPER</b> cables	Cable formation and conductor cross sections (n° x mm <sup>2</sup> )				Dimensions A x B (mm)
	2x	3x	4x	5x	
<b>Product</b>					
Magic Joint SP L6	1,5 - 6	1,5 - 6	1,5 - 6	1,5 - 6	180 x 50
Magic Joint SP L16	4 - 16	4 - 16	4 - 16	4 - 16	215 x 55
Magic Joint SP L25	4 - 25	4 - 25	4 - 25	4 - 25	215 x 65



## Magic Joint System Plus Y

Y branch joint with **cast gel**  
Five-core spacer + screw connectors.

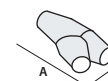

For <b>COPPER</b> cables	Cable formation and conductor cross sections (n° x mm <sup>2</sup> )								Dimensions A x B (mm)
	2x		3x		4x		5x		
<b>Product</b>	T	B	T	B	T	B	T	B	
Magic Joint SP Y6	1,5 - 6	1,5 - 4	1,5 - 6	1,5 - 4	1,5 - 6	1,5 - 4	1,5 - 6	1,5 - 4	180 x 90
Magic Joint SP Y16	4 - 16	1,5 - 4	4 - 16	1,5 - 4	4 - 16	1,5 - 4	4 - 16	1,5 - 4	220 x 105



## Magic Joint System Plus T

T branch joint with **cast gel**  
Five-core spacer + screw connectors.

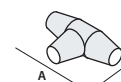

For <b>COPPER</b> cables	Cable formation and conductor cross sections (n° x mm <sup>2</sup> )						Dimensions A x B (mm)
	2x		3x		4x		
<b>Product</b>	T	B	T	B	T	B	
Magic Joint SP T35	6 - 35	1,5 - 10	6 - 35	1,5 - 10	6 - 35	1,5 - 10	305 x 155

- Joints insulated with **Magic Gel**
- Quick cross linking gel (only 10 minutes)
- Extremely adherent and tight sealing
- Non-toxic and no shelf life
- For 0.6/1 kV extruded cables

Operating temperature **90°**

Installation temperature:  
-10°C / +45°C





## Raycast System Plus L

Straight joint with **cast resin**  
complete with spacer and screw connectors.

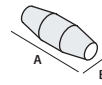

For <b>COPPER</b> cables	Cable formation and conductor cross sections (n° x mm <sup>2</sup> )				Dimensions A x B (mm)
Product	2x	3x	4x	5x	
Raycast SP L6	1,5 - 6	1,5 - 6	1,5 - 6	1,5 - 6	180 x 50
Raycast SP L16	4 - 16	4 - 16	4 - 16	4 - 16	215 x 55
Raycast SP L25	4 - 25	4 - 25	4 - 25	4 - 25	215 x 65



## Raycast System Plus Y

Y branch joint with **cast resin**  
complete with spacer and screw connectors.

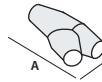

For <b>COPPER</b> cables	Cable formation and conductor cross sections (n° x mm <sup>2</sup> )								Dimensions A x B (mm)
Product	2x		3x		4x		5x		
	T	B	T	B	T	B	T	B	
Raycast SP D6	1,5 - 6	1,5 - 4	1,5 - 6	1,5 - 4	1,5 - 6	1,5 - 4	1,5 - 6	1,5 - 4	180 x 90
Raycast SP D16	4 - 16	1,5 - 4	4 - 16	1,5 - 4	4 - 16	1,5 - 4	4 - 16	1,5 - 4	220 x 105

T: Through - B: Branch



## Raycast System Plus T

T branch joint with **cast resin**  
complete with spacer and screw connectors.

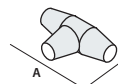

For <b>COPPER</b> cables	Cable formation and conductor cross sections (n° x mm <sup>2</sup> )						Dimensions A x B (mm)
Product	2x		3x		4x		
	T	B	T	B	T	B	
Raycast SP T 35	6 - 35	1,5 - 10	6 - 35	1,5 - 10	6 - 35	1,5 - 10	305 x 155

T: Through - B: Branch



- Joints insulated with **Ray Resin** bicomponent epoxy resin
- For 0.6/1 kV extruded cables

90° Operating temperature

Installation temperature: -0°C / +45°C



# SYSTEM FAST RP

Straight joints with four shear bolt connectors.  
The reliability of Raytech joints coupled  
with convenience and ease of installation.

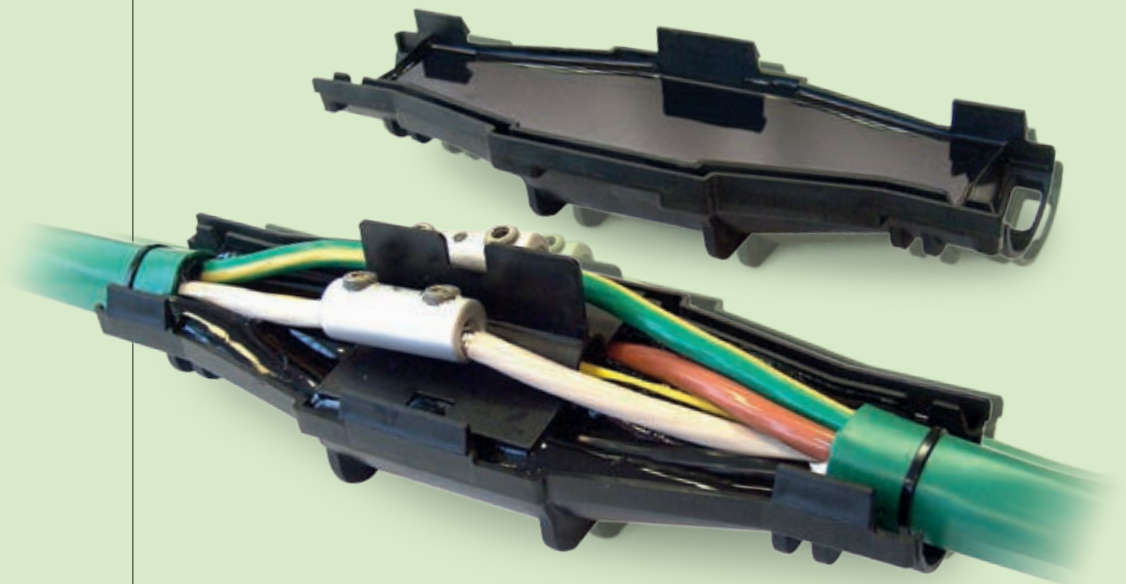



- No more crimping or single screw connectors
- Screw connections break automatically when correct tightening torque is reached, ensuring perfect connection
- Suitable for copper and aluminium conductors (aluminium conductors with minimum section 10 mm<sup>2</sup>)

**Electrical performance:**

CEI EN 50393 • CEI 20-33  
(with testing under water head and water between the cable cores)

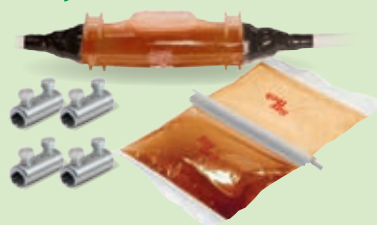
**Rapid Joint RIP 68****Rapid Joint RP****Magic Power Joint RP****Raycast RP****Magic Joint RP****GVL RP**





Operating temperature **90°**

Installation temperature: **-40°C / +50°C**

## Rapid Joint IP68 System Fast RP

Straight joint pre-filled with gel.

Product	Formation n°	Configuration IP68			Configuration IPX8		
		Section mm <sup>2</sup>	Ø cable mm	A x B (mm)	Section mm <sup>2</sup>	Ø cable mm	A x B (mm)
Rapid Joint L6-RIP68/1	o	25 - 50	12 - 18	245 x 60	<del>25 - 50</del>	24	180 x 60
Rapid Joint L6-RIP68/2	oo	1,5 - 10	12 - 18		1,5 - 10	24	
Rapid Joint L6-RIP68/3	ooo	1,5 - 6	12 - 18		1,5 - 10	24	
Rapid Joint L6-RIP68/4	oooo	1,5 - 6	12 - 18		1,5 - 10	24	
Rapid Joint L10-RIP68/1	o	70 - 95	16 - 20	275 x 65	35 - 150	31	210 x 65
Rapid Joint L10-RIP68/2	oo	10 - 16	16 - 20		10 - 25	31	
Rapid Joint L10-RIP68/3	ooo	10	16 - 20		10 - 25	31	
Rapid Joint L10-RIP68/4	oooo	10	16 - 20		10 - 25	31	



Installation temperature: **-40°C / +50°C**

Operating temperature **90°**

## Rapid Joint System Fast RP

Straight joint pre-filled with gel.

Product	Cable formation from 2x a 4x (n° x mm <sup>2</sup> )	Dimensions A x B (mm)
Rapid Joint L 10 RP	1,5 - 10	180 x 60
Rapid Joint L 25 RP	10 - 25	210 x 65
Rapid Joint L 95 RP	35 - 95	320 x 100



Operating temperature **90°**

Installation temperature: **-40°C / +50°C**

## Magic Power Joint System Fast RP

Straight joint with Magic Power Gel.

Product	Cable formation from 2x a 4x (n° x mm <sup>2</sup> )	Dimensions A x B (mm)
Magic P Joint L 35- RP/16	1,5 - 16	232 x 70
Magic P Joint L 35- RP/35	10 - 35	232 x 70
Magic P Joint L 50- RP/50	25 - 50	266 x 72
Magic P Joint L 120- RP/120	35 - 120	365 x 95
Magic P Joint L 240- RP/150	35 - 150	510 x 120



## Magic Joint System Fast RP

Straight joint with Magic Gel.

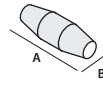

Product	Cable formation from 2x a 4x (n° x mm <sup>2</sup> )	Dimensions A x B (mm)
Magic Joint 35- RP/16	1,5 - 16	232 x 70
Magic Joint 35- RP/35	10 - 35	232 x 70
Magic Joint 50- RP/50	25 - 50	266 x 72
Magic Joint 120- RP/120	35 - 120	365 x 95
Magic Joint 240- RP/150	35 - 150	510 x 120



90° Operating temperature  
 Installation temperature: -10°C / +45°C

## Raycast System Fast RP

Straight joint with Ray Resin epoxy resin.

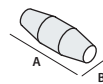

Product	Cable formation from 2x a 4x (n° x mm <sup>2</sup> )	Dimensions A x B (mm)
Raycast L 35- RP/16	1,5 - 16	232 x 70
Raycast L 35- RP/35	10 - 35	232 x 70
Raycast L 50- RP/50	25 - 50	266 x 72
Raycast L 120- RP/120	35 - 120	365 x 95
Raycast L 240- RP/150	35 - 150	510 x 120

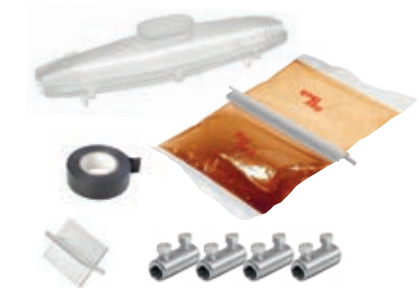

90° Operating temperature  
 Installation temperature: 0°C / +45°C

## GLV System Fast RP

Straight heat-shrink joint.

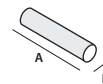

Product	Cable formation 4x (n° x mm <sup>2</sup> )	Dimensions A x B (mm)
GLV 0435- RP/16	6 - 16	650 x 50
GLV 0470- RP/35	25 - 35	650 x 70
GLV 0470- RP/50	25 - 50	650 x 75
GLV 4150- RP/150	50 - 150	800 x 80



90° Operating temperature  
 Installation temperature: -15°C / +45°C



### Shear bolt connectors

Product	Aluminium cross sections (mm <sup>2</sup> )	Copper cross sections (mm <sup>2</sup> )	Breakaway torque (Nm)	Dimensions		
				L	D	d
Ray-TTF 1,5/16	10 - 16	1,5 - 16	4	30	12	6,1
Ray-TTF 10/35	10 - 35	10 - 35	10	36	16	9,0
Ray-TTF 25/50	25 - 50	25 - 50	12	36	18	10,0
Ray-TTF 35/150	35 - 150	35 - 150	30	70	28	17,0

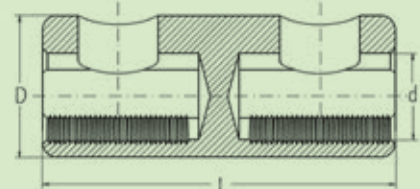



**Electrical performance:**  
CEI EN 50393 with connectors  
complying with EN 61238-1  
(with testing under water head  
and water between the cable cores)  
Class 2 in accordance with CEI 64-8.

**No flame propagation:**  
CEI 20-35 • IEC 60332-1 HD405-1  
(as applicable)

Operating temperature  90°

Installation temperature:  -15°C / +45°C

# Heat-shrink

Straight or branch heat-shrinkable joints  
for extruded insulation cables up to a 1 kV.

## Installation sequence

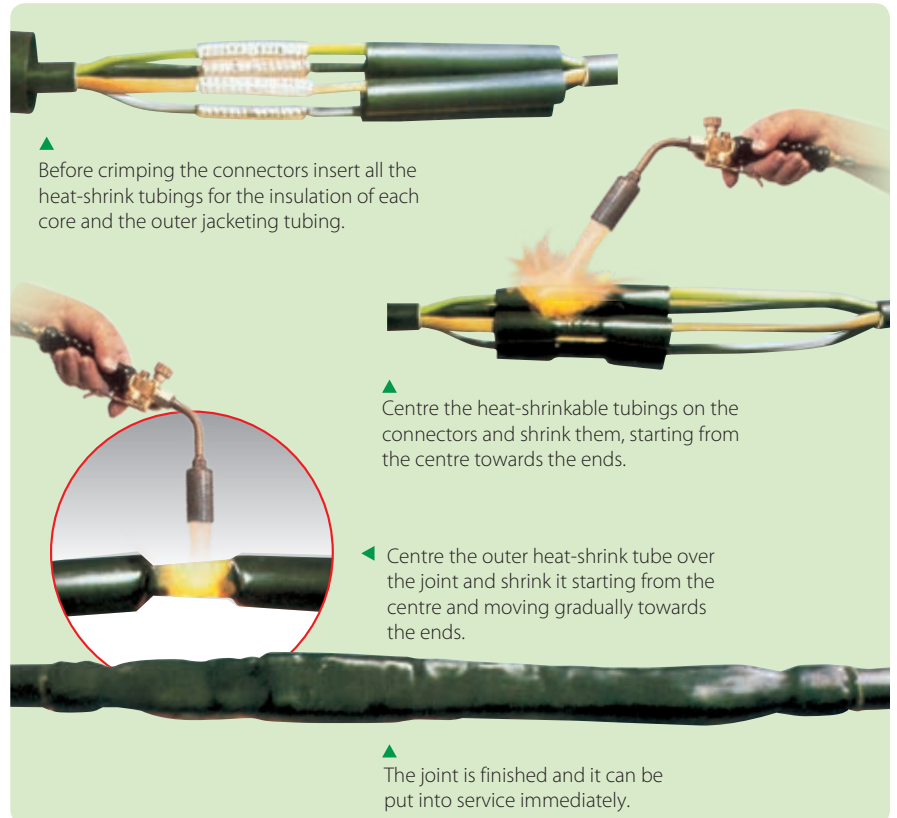





## GDL

Joint for single core cables including concentric neutral.

Product	Conductor cross section mm <sup>2</sup>		Dimensions L (mm)
	from	to	
GDL 92 A1	4	10	300
GDL 92 A2	16	150	300
GDL 92 A3	185	400	300
GDL 92 PA	10	50	300

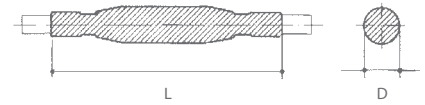

## GLV

Joint for multi core cables (also for submersible pumps).

Product	Conductor cross section mm <sup>2</sup>		Number of phases	Dimensions L (mm) D (mm)	
	from	to		L (mm)	D (mm)
GLV 0306	1,5	6	3	250	18
GLV 0316	10	16	3	400	37
GLV 0335	25	35	3	550	43
GLV 0370	50	70	3	650	52
GLV 3150	95	150	3	800	65
GLV 3300	185	300	3	900	82
GLV 0406	1,5	6	4	250	20
GLV 0416	10	16	4	400	40
GLV 0435	25	35	4	650	45
GLV 0470	50	70	4	650	54
GLV 4150	95	150	4	800	67
GLV 4300	185	300	4	900	84
GLV 2,5 - CP	2,5 complete with connectors		4	300	15

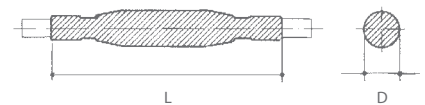

For both copper and aluminium cables. For aerial, underground, submerged installation.

## GLV-N

Joint for multi core cables with concentric neutral.

Product	Conductor cross section mm <sup>2</sup>		Number of phases	Dimensions L (mm) D (mm)	
	from	to		L (mm)	D (mm)
GLV 0306 - N	1,5	6	3	250	18
GLV 0316 - N	10	16	3	400	37
GLV 0335 - N	25	35	3	550	43
GLV 0370 - N	50	70	3	650	52
GLV 3150 - N	95	150	3	800	65
GLV 3300 - N	185	300	3	900	82
GLV 0406 - N	1,5	6	4	250	20
GLV 0416 - N	10	16	4	400	40
GLV 0435 - N	25	35	4	650	45
GLV 0470 - N	50	70	4	650	54
GLV 4150 - N	95	150	4	800	67
GLV 4300 - N	185	300	4	900	84

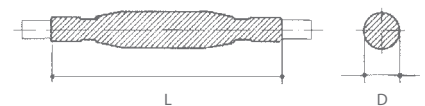

These kits include components for the phase insulation, metallic braiding to replace the neutral and external self-sealing heat-shrinkable tube.

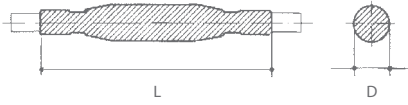

## GLV-ARM

Joint for armoured multi core cables.

Product	Conductor cross section (mm <sup>2</sup> )		Dimensions	
	from	to	L (mm)	D (mm)
GLV 0406-ARM	1,5	6	300	25
GLV 0416-ARM	6	16	400	40
GLV 0450-ARM	25	50	800	60
GLV 4150-ARM	70	150	1000	100
GLV 4300-ARM	185	300	1000	120

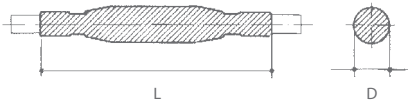

## BOPA

Joint for MV cables for public lighting.

Product	Operating voltage kV	Number of phases	Section (mm <sup>2</sup> )	Dimensions	
				L (mm)	D (mm)
BOPA 3	3	1	1x10	300	50
BOPA 4	3	2	2x10	450	60
BOPA 5	3	3	3x10	450	70
BOPA 3/2	3,6	1 + concentric neutral	1 x 6 + 6 concentric	700	35
BOPA 4/T transition	3	2	2,5 - 10 paper / 10 - 50 extruded	750	40

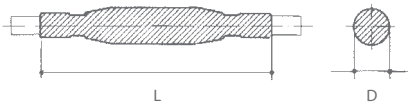

## DJ

LV branch joint.

Product	Single core cables cross section (mm <sup>2</sup> )		Multi core cables cross section (mm <sup>2</sup> )		Dimensions	
	Through	Branch	Through	Branch	L (mm)	D (mm)
DJ01	1 x 4 - 50	1 x 2,5 - 50	4 x 1,5 - 10	2 x 1,5	200	25
DJ02	1 x 50 - 120	1 x 6 - 120	4 x 16 - 25 2 single core cables 1 x 6 - 50	2x1,5 1 two core cable 2 x 2,5	250	40
DJ03	1x150-300	1 x 6 - 300	4 x 25 - 3,5 x 50	4 x 2,5 - 25	400	70



## GLV F/R - GMP F/R

Joint for fire resistant cables (0,6/1 kV).

FOR NAVAL TYPE POWER CABLES

UNARMOURED			ARMOURED		
Product	Cable formation (n° x mm <sup>2</sup> )	L (mm)	Product	Cable formation (n° x mm <sup>2</sup> )	L (mm)
GLV 4004-F/R	4 x 1,5 - 4	300	GLV 4004-ARM-F/R	4 x 1,5 - 4	400
GLV 4016-F/R	4 x 6 - 16	300	GLV 4016-ARM-F/R	4 x 6 - 16	400
GLV 4050-F/R	4 x 25 - 50	400	GLV 4050-ARM-F/R	4 x 25 - 50	500
GLV 4150-F/R	4 x 70 - 150	500	GLV 4150-ARM-F/R	4 x 70 - 150	750

FOR NAVAL TYPE SIGNALLING AND CONTROL CABLES

UNARMOURED			ARMOURED		
Product	Cable formation (n° x mm <sup>2</sup> )	L (mm)	Product	Cable formation (n° x mm <sup>2</sup> )	L (mm)
GMP 007-F/R	4 - 7 x 1,5 - 2,5	300	GMP 007-ARM-F/R	4 - 7 x 1,5 - 2,5	400
GMP 014-F/R	10 - 14 x 1,5 - 2,5	300	GMP 014-ARM-F/R	10 - 14 x 1,5 - 2,5	400
GMP 030-F/R	16 - 30 x 1,5 - 2,5	400	GMP 030-ARM-F/R	16 - 30 x 1,5 - 2,5	500

FOR UNDERGROUND POWER CABLES

UNARMOURED			ARMOURED		
Product	Cable formation (n° x mm <sup>2</sup> )	L (mm)	Product	Cable formation (n° x mm <sup>2</sup> )	L (mm)
GLV 4006-F/R-G7	4 x 1,5 - 6	300	GLV 4006-ARM-F/R-G7	4 x 1,5 - 6	400
GLV 4016-F/R-G7	4 x 6 - 16	300	GLV 4016-ARM-F/R-G7	4 x 6 - 16	400
GLV 4050-F/R-G7	4 x 25 - 50	400	GLV 4050-ARM-F/R-G7	4 x 25 - 50	500
GLV 4150-F/R-G7	4 x 70 - 150	500	GLV 4150-ARM-F/R-G7	4 x 70 - 150	750

FOR UNDERGROUND SIGNALLING AND CONTROL CABLES

UNARMOURED			ARMOURED		
Product	Cable formation (n° x mm <sup>2</sup> )	L (mm)	Product	Cable formation (n° x mm <sup>2</sup> )	L (mm)
GMP 014-F/R-G7	Fino a 14 x 1,5 - 2,5	300	GMP 014-ARM-F/R-G7	Fino a 14 x 1,5 - 2,5	400
GMP 019-F/R-G7	Fino a 19 x 1,5 - 2,5	400	GMP 019-ARM-F/R-G7	Fino a 19 x 1,5 - 2,5	500

## DJ F/R

Branch joint for fire resistant cables (0,6/1 kV).

FOR POWER CABLES

UNARMOURED	ARMOURED	Cable formation (n° x mm <sup>2</sup> )		L
Product	Product	Through	Branch	(mm)
DJ 4016 - F/R	DJ 4016 - ARM-F/R	3 - 4 x 1,5 - 16	3 - 4 x 1,5 - 16	300

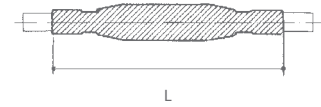

### Electrical performance:

CEI EN 50393 with connectors complying with EN 61238-1 (with testing under water head and water between the cable cores)  
Class 2 in accordance with CEI 64-8.

### Flame resistance:

IEC 60331-21 • CEI 20-36/2-1 (as applicable)

Contact Raytech for information regarding other formations and cable sections



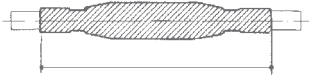

## GMP

Joint kits for multi conductor cables for signalling, command and control.

NON ARMoured cable		N° of conductors		Section mm <sup>2</sup>		External Ø of cable	
Product		from	to	from	to	min (mm)	max (mm)
GMP 007		4	7	1,0	2,5	8	19
GMP 014		8	14	1,0	2,5	12	22
GMP 021		15	21	1,0	2,5	15	27
GMP 040		22	40	1,0	2,5	20	35
GMP 075		41	75	1,0	2,5	26	44
GMP 100		76	100	1,0	2,5	26	60

ARMoured cable		N° of conductors		Section mm <sup>2</sup>		External Ø of cable	
Product		from	to	from	to	min (mm)	max (mm)
GMP 007-A		4	7	1,0	2,5	14	23
GMP 014-A		8	14	1,0	2,5	15	26
GMP 021-A		15	21	1,0	2,5	24	35
GMP 040-A		22	40	1,0	2,5	30	45
GMP 075-A		41	75	1,0	2,5	39	55

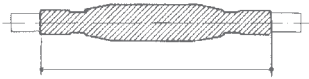

## GMC

Joint kits for multi pair cables for communication, command or control.

NON ARMoured cable		N° of pairs		Section mm <sup>2</sup>		External Ø of cable	
Product		from	to	from	to	min (mm)	max (mm)
GMC 010		5	10	2 x 0,6	2 x 1,0	9	14
GMC 020		11	20	2 x 0,6	2 x 1,0	13	20
GMC 030		21	30	2 x 0,6	2 x 1,0	16	24
GMC 050		31	50	2 x 0,6	2 x 1,0	22	29
GMC 100		51	100	2 x 0,6	2 x 1,0	30	40

ARMoured cable		N° of pairs		Section mm <sup>2</sup>		External Ø of cable	
Product		from	to	from	to	min (mm)	max (mm)
GMC 004-A		1	4	2 x 0,6	2 x 1,0	15	23
GMC 007-A		5	7	2 x 0,6	2 x 1,0	15	26
GMC 019-A		8	19	2 x 0,6	2 x 1,0	24	35
GMC 037-A		20	37	2 x 0,6	2 x 1,0	30	45
GMC 061-A		38	61	2 x 0,6	2 x 1,0	39	55



# Terminals heat-shrink

## TLV

Terminations for armoured and non armoured extruded cables up to 1 kV.

NON ARMoured extruded cables	Extruded cables with WIRE ARMOUR	Section conductor mm <sup>2</sup>		Number of phases
Product	Product	from	to	
TLV 0216	TLV 0216 - AF	4	16	2
TLV 0316	TLV 0316 - AF	4	16	3
TLV 0416	TLV 0416 - AF	4	16	4
TLV 0250	TLV 0250 - AF	25	50	2
TLV 0350	TLV 0350 - AF	25	50	3
TLV 0450	TLV 0450 - AF	25	50	4
TLV 3150	TLV 3150 - AF	70	150	3
TLV 4150	TLV 4150 - AF	70	150	4
TLV 3300	TLV 3300 - AF	185	300	3
TLV 4300	TLV 4300 - AF	185	300	4
	TLV 4500 - AF	500		4

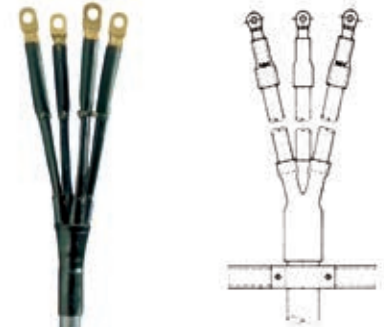

Include sheath to cover phases, sealing of the point of divergence of phases and sealing between phase and cable terminal.

## TLV 500

Terminations for concentric neutral extruded cables up to 1 kV.

Product	Section conductor mm <sup>2</sup>		Number of phases
	from	to	
TLV 0116 - 500	4	16	1
TLV 0216 - 500	4	16	2
TLV 0316 - 500	4	16	3
TLV 0150 - 500	25	50	1
TLV 0250 - 500	25	50	2
TLV 0350 - 500	25	50	3
TLV 2150 - 500	70	150	2
TLV 3150 - 500	70	150	3
TLV 2300 - 500	185	300	2
TLV 3300 - 500	185	300	3







Include sheath to cover the concentric conductor.

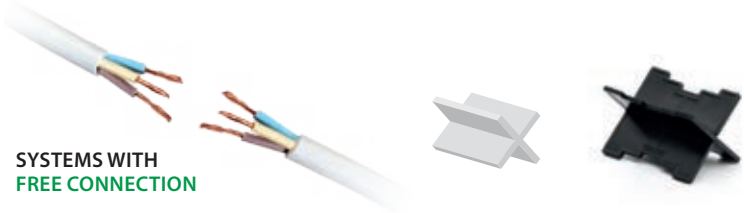

**SYSTEMS WITH  
FREE CONNECTION**



TYPE OF JOINT		Magic Power Joint	Magic Joint	Rapid Joint	Clic Joint	Rubber Joint	Raycast	Wonder Joint	GLV
	PRE-FILLED			●	●				
	FOR CASTING	●	●			●	●		
	INJECTABLE							●	
	HEAT-SHRINK								●
	extra-fast installation			●				●	
	fast installation	●	●		●	●	●		
	straight	●	●	●	●	●	●	●	●
	branch	●	●		●	●	●	●	●
	for copper cable	●	●	●	●	●	●	●	●
	for aluminium cable	●	●	●		●	●		●
	for screened cable	●		●			●		●
	for armoured cable	●		●			●		●
	for signalling and control	●		●			●		●
	for telephone cable	●		●			●		●
	1x single core cable	●	●	●	●	●	●	●	
	2x two-core cable	●	●	●	●	●	●	●	●
	3x three-core cable	●	●	●	●	●	●	●	●
	4x four-core cable	●	●	●	●	●	●	●	●
	5x five-core cable								
	for cables up to 630 mm <sup>2</sup>	●	●				●		●
	flame retardant	●	●	●	●	●		●	●
	complete with separator	●	●	●	●	●	●	●	
	complete with screw connectors								
	for underwater use	●	●	●	●	●	●	●	●
	for high depth	●		●				●	●
	re-enterable	●	●	●	●	●		●	●
	Non-toxic / without shelf life	●	●	●	●	●		●	●





# FILLERS

Insulators and sealing for protecting electrical connections.



## Gel

BICOMPONENT CAST

page  
90



**Magic Power Gel**  
Self-amalgamating bicomponent gel in single bottles



**Magic Gel**  
Bicomponent gel in bottles



**Magic Fluid**  
Bicomponent gel in single dose bags



**Ray Gel**  
Bicomponent gel in bottles for telephone and intercom systems



**Bag Gel**  
Bicomponent gel in bags for telephone and intercom systems

## Rubber

BICOMPONENT PASTE/CAST

page  
105



**Sky Plast**  
Mouldable bicomponent rubber



**Magic Rubber & Rubber Fluid**  
Bicomponent rubber in bottles or single dose bags



# Gel

SINGLE COMPONENT INJECTABLE

page  
96



**Wonder Gel**  
Single coloured component



**Wonder Gel Invisible**  
Single transparent component



**Wonder Fluid**  
Single fluid component



**Monogel**  
Single coloured component



# Gelgum

BICOMPONENT CAST

page  
102



**TechnoGelGum**  
Bicomponent in single bottle

## GelGum Joint

Kit Techno Gel Gum + joints



# Resin

BICOMPONENT CAST

page  
107



## Ray Resin

Bicomponent epoxy resin in single dose bags





# Magic Power Gel

The unique bi-component gel in a single bottle, with superior dielectric, sealing and thermal characteristics, re-enterable and re-usable!

- Very sticky
- Strong self amalgamating characteristics
- Single compact bottle; convenient twin compartment
- Re-usable as well as re-enterable, even after long working periods
- It doesn't give any waste
- Non toxic and safe

## INSULATING and SEALING GEL



## RE-ENTERABLE



## RE-USABLE







### Stickiness

- Exceptional sealing properties in any condition
- Better resistance to pressure
- Effective even in vertical or ceiling applications

### Self-agglomerating

- Once cross linked it perfectly adheres on itself characteristics to get an homogeneous and compact mass
- It can be therefore applied in multiple layers

### Zero waste

- Due to the nature of the product waste is eliminated; even residual product can be saved and used for the next application
- Also any left over product maintains it's high performance characteristics

### Single bottle

- Highly useful
- The most compact packaging
- Less space occupied in the toolbox
- Both components in the same packaging

## Magic Power Gel

Product	Colour	Package type	Quantity
Magic Power Gel	•	1 single, bi-component bottle 1 small basin - 1 mixing spoon	1000 ml
Magic Power Gel 500	•	1 single, bi-component bottle 1 small basin - 1 mixing spoon	500 ml
Magic Power Gel 250	•	1 single, bi-component bottle	250 ml

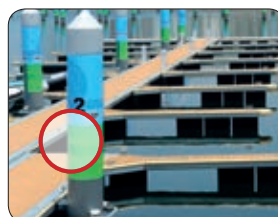



Gel: UL 94-HB **CE** **UL** **US**

**Dielectric strength:**  
>23 kV/mm

**Cross linking time:**  
fast (about 10 min. at 23°C)

**Volume resistivity:**  
>2 . 10<sup>15</sup> Ω cm

**Working temperature:**  
-60°C / +200°C

**Overload temperature for short periods:**  
up to 250°C

**Stabilised for:**  
mould - UV

**Degree of protection:**  
IP68 (in proper casings)

**IP68** | **IMQ**  
OFFICIALLY TESTED

# Magic Gel & Magic Fluid

Bicomponent gel with very high dielectric and thermal characteristics, ideal for connection systems (joint shells or enclosures) for power cables.

The insulating and sealing gel, when cast in suitable casings, ensures an IP68 degree of protection and it is able to replace all types of resins. This is a self-polymer insulation in two practical bottles or in a single use bag, with cold cross linking. Once poured, the insulation, characterized by very low viscosity, surrounds and envelopes any type of material, cross linking in less than 10 minutes. Completely non-toxic, cross linking with a very slow isothermal peak that does not thermally stress the materials it comes into contact with.

- For high temperature applications!
- Quick cross linking (only 10 minutes)
- Re-enterable also after long working periods
- Non-toxic and safe with no shelf life
- Low viscosity



Examples of use



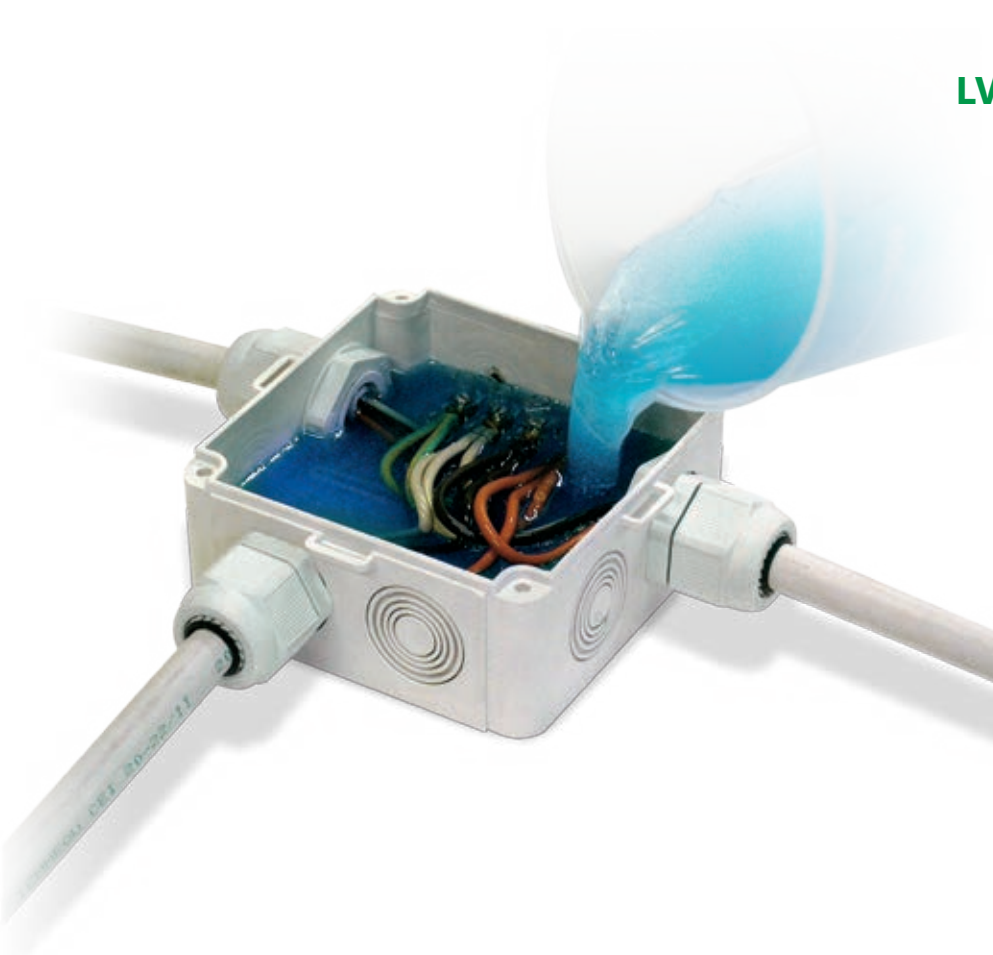

### Magic Gel

Product	Colour	Package type	Total quantity
Magic Gel 300	●	2 bottles	300 ml
Magic Gel 1000	●	2 bottles - 1 small basin - 1 mixing spoon	1000 ml
Magic Gel 2000	●	2 bottles - 1 small basin - 1 mixing spoon	2000 ml
Magic Gel 10000	●	2 tanks - 1 small basin - 1 mixing spoon	10 lt

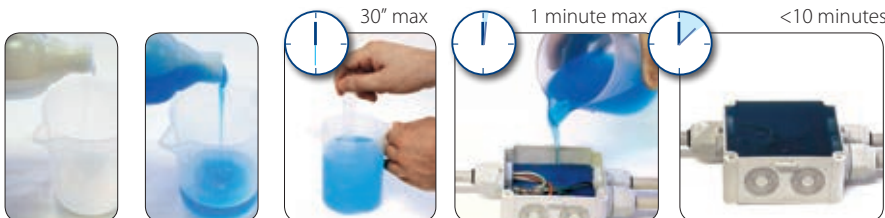

### Magic Fluid

Product	Colour	Package type	Total quantity
Magic Fluid 90	●	Bicomponent single dose bags	90 gr
Magic Fluid 110	●	Bicomponent single dose bags	110 gr
Magic Fluid 170	●	Bicomponent single dose bags	170 gr
Magic Fluid 210	●	Bicomponent single dose bags	210 gr
Magic Fluid 420	●	Bicomponent single dose bags	420 gr
Magic Fluid 550	●	Bicomponent single dose bags	550 gr



### Problem ENERGY

What does a gel for this type of system have to give?

- ✓ **INSULATION:** Elevated voltages (1 kV operating, 4 kV testing)
- ✓ **THERMAL PERFORMANCE:** Operating temperature 90°C, overload temperature 130°C, short circuit temperature 250°C
- ✓ **SEALING:** Installations also possible in humid environments, flooded wells
- ✓ **DEGREE OF PROTECTION:** Must also work with water between the cores of the cable
- ✓ **CERTIFIED SYSTEMS:** The combination of insulation gel + casing must comply with current standards CEI 20-33 and EN 50393

**Solution:** *Magic Gel* meets all your Energy system requirements!





# Ray Gel

Gel: UL 94-HB 

**Dielectric strength:**  
>23 kV/mm

**Cross linking time:**  
fast (about 3 min. at 30°C)

**Volume resistivity:**  
>1,5 x 10<sup>15</sup> Ω cm

**Operating temperature:**  
-60°C / +180°C

**Thermal conductivity:**  
< 0,2 W/m<sup>2</sup>K

**Dielectric constant:**  
< 7

**Degree of protection:**  
IP68 (in proper casings)

**IP68**  
OFFICIALLY  
TESTED | **IMQ**

Insulating, sealing, re-enterable fast cross linking bicomponent silicone gel for telephone and intercom systems and for LED and display protection.

- Quick cross linking
- Antioxidant protection
- Low temperature resistant
- Non-toxic and safe with no shelf life







**RED**

- Specially formulated for UV resistance
- Suitable for "surface" installations
- Ideal for intercom systems



**TRANSPARENT**

- Excellent transparency
- Does not opacify
- Ideal for protecting printed circuit boards, for sealing displays, for insulating and sealing LEDs



Ray Gel / Bag Gel

Product	Colour	Package type	Total quantity
Bag Gel 200-T	○	Bicomponent single dose bags	200 gr
Bag Gel 400-T	○		400 gr
Bag Gel 200-R	●		200 gr
Bag Gel 400-R	●		400 gr
Ray Gel 300-T	○	2 bicomponent bottles	300 gr
Ray Gel 1000-T	○		1000 gr
Ray Gel 300-R	●		300 gr
Ray Gel 1000-R	●		1000 gr
Ray Gel 10K-T	○	2 bicomponent boxes	10 kg
Ray Gel 20K-T	○		20 kg
Ray Gel 10K-R	●		10 kg
Ray Gel 20K-R	●		20 kg

**Problem TELECOM**

What does a gel for this type of system have to give?

- ✓ **SEALING:**  
Installations also possible in humid environments, flooded wells
- ✓ **DEGREE OF PROTECTION:**  
IP68 in proper casing
- ✓ **PREVENTION FROM OXIDATION:**  
Contacts in Telecom connections shouldn't give attenuations (low signal currents)
- ✓ **HIGH INSULATION FLUIDITY:**  
During casting, the the insulation has to fill all interstitial spaces between the cores of the cable
- ✓ **ANTICRACKING:**  
Insulation in the permanently cold joint should not crack at low temperatures
- ✓ **INSULATION:**  
The filler should be an insulating component

**Solution:** Ray Gel meets all your Telecom system requirements





**IP68**  
OFFICIALLY  
TESTED | **IMQ**  
(in proper casings)

# Wonder Gel

Single component insulating gels in cartridge to instantly protect new installations and oversee maintenance of all types of electrical connections.

**Installer's best friends.** Electrical connections, within empty enclosures, are exposed to the risk of short circuit, oxidation and corrosion, at times, resulting in irreparable damages. Without stress and no waiting around, **WonderGel** and **WonderGel Invisible** make your job easier, guaranteeing the protection and safety of systems in compliance to best practice rules to provide the highest quality solution, quick and perfect to get the satisfaction of both you and your clients.

- Ready to use! No mixing required!  
Already cross-linked! No need to wait!
- Resolve issues connected to incorrect insulation or sealing
- Eliminate annoying out of service instances caused by moisture
- Protect your systems from the penetration of insects
- Protect your electrical connections from oxidation and corrosion
- Italian Utility Model 

VIDEO SURVEILLANCE SYSTEMS



CONNECTIONS IN MOIST ENVIRONMENTS



UNDERGROUND CONNECTIONS

***Time and  
space-saver***

**EASY TO APPLY EVEN  
IN AREAS WHICH ARE  
DIFFICULT TO ACCESS!**



***Always at your  
fingertips!***



INSPECTABLE



EXTERNAL SYSTEMS



UNDERGROUND CONNECTIONS



SMALL-SCALE CONNECTIONS

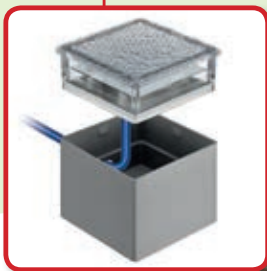

GROUND LUMINAIRES

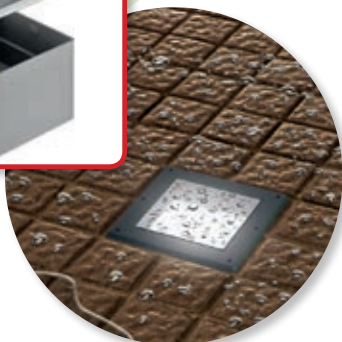

**WHAT IS GEL WONDER?**

- A single component gel
- Extremely sticky
- Stays soft with time
- Never dries
- Non-toxic and safe
- No shelf life



**WHAT DOES GUARANTEE?**

- Maximum insulation and sealing
- Effective and stable adhesion with the passing of time
- High resistance to water pressure
- Degree of protection IP68 when dispensed in suitable casings



**WHY IS IT IN A CARTRIDGE?**

- Always ready to use and at your fingertips
- Can be used with standard guns
- It is measurable
- No waste
- Complete with nozzle
- Extremely rapid to use even in difficult positions
- Compact

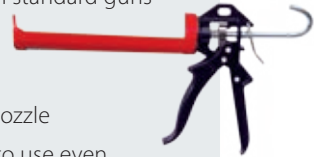





# WonderGel & WonderGel INVISIBLE

## Characteristics

- Single component gel which comes already cross-linked in a cartridge
- No mixing, no waiting time
- Visco-elastic gel which is extremely fluid
- Self-levelling and self-vulcanizing
- Can be applied using standard silicone ratchets
- Easy to measure
- Does not expire and does not harden
- Easy to apply even to inaccessible areas
- Characteristics do not deteriorate with the passing of time
- Re-enterable
- Non-toxic and safe
- Can be applied in all weather conditions, even when raining or in the heat of the summer sun
- Can be applied to powered appliances
- Dielectric strength > 23 kV/mm
- Volume resistivity > 2. 10<sup>15</sup> Ω cm
- Operating temperature from -60 / +200°C
- Overload temperature for brief periods: 250°C
- Gel UL 94-HB

\* Protection degree IP68 in proper casings



## Wonder Gel

Product	Colour	Package type	Total quantity
Wonder Gel	●	Cartridge with measuring nozzle	280 ml
Wonder Gel Invisible	○	Cartridge with measuring nozzle	280 ml

# Gel technology comparison

				
PRODUCT	<b>MAGIC GEL</b> Bi-component gel in 2 bottles	<b>MAGIC POWER GEL</b> Bi-component gel in single, 2 compartment bottle	<b>WONDER GEL</b> Ready-to-use single component gel in a cartridge	
METHOD OF APPLICATION	 MIX AND POUR	 <b>1</b> MIX AND POUR	 <b>2</b> MIX, WAIT & STICK	 INJECT
INSTALLATION TEMPERATURE (°C)	- 5 * -10 ** / +45 -15 ***	- 5 * -10 ** / +55 -15 ***	-40 / +60	-40 / +110
OPERATING TEMPERATURE (°C)	-60 / +200	-60 / +200	-60 / +200 Ready to use in 15 min	-60 / +200 Ready to use
CROSS LINKING TIME (minutes at 25°C)	< 10 min.	ca. 15 min.	-	-
PRINCIPAL CHARACTERISTICS	RE-ENTERABLE	RE-ENTERABLE REUSABLE	STICKY RE-ENTERABLE REUSABLE	INJECTABLE RE-ENTERABLE

\* Poured at -5°C from bottles stored at >10°C.

\*\* Poured at -10°C from bottles stored at >20°C.

\*\*\* Poured at -15°C from bottles stored at -15°C (cross linking within 48 hours).

Raytech gels can be used for the filling and sealing of all junction boxes and are ideal to ensure maximum protection if applied in cable jointing systems of our production.

# Wonder Fluid

Single component insulation fluid gel cartridge.

Gel: UL 94-HB

- Operating temperature:**  
-60°C / +200°C
- Installation temperature:**  
-40°C / +110°C
- Dielectric strength:**  
> 23 kV/mm
- Degree of protection:**  
IP68 (in proper casings)

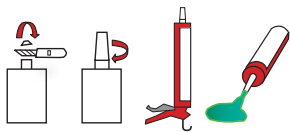

- Ready-to-use fluid gel
- Created for filling new Raytech joint shells with no-return valves
- Suitable for filling trays
- Does not solidify when opened
- No waste
- No shelf life



**IP68**



**IP68**

## Wonder Fluid

Product	Colour	Package type	Total quantity
Wonder Fluid 210	●	Cartridge with measuring nozzle	210 ml
Wonder Fluid 280	●	Cartridge with measuring nozzle	280 ml



# Monogel

Single component transparent insulation gel for generic use.

- Ready to use
- No shelf life



**Gel:** UL 94-HB

**Operating temperature:**

-60°C / +200°C

**Installation temperature:**

-40°C / +110°C

**Dielectric strength:**

> 23 kV/mm

**Degree of protection:**

IP68 (in proper casings)

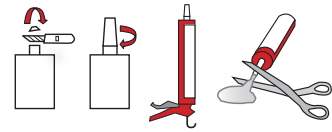

## Monogel

Product	Colour	Package type	Total quantity
Monogel	○	Cartridge with measuring nozzle	300 ml

# Techno Gel Gum

Single bottle two-component insulation with very high dielectric, thermal and sealing characteristics. Waterproof and re-enterable!

TechnoGelGum is a strong hold flexible elastomer whose formula has been optimised for the protection of POWER CABLE, TELECOM CABLE and ELECTRONIC CIRCUIT connections. A new recipe that gives the product a surprising, original texture that combines the characteristics of GEL and RUBBER to emphasise its features. It's elastic and flexible like gel, but also tough and dry like rubber.

**Dielectric strength:**  
≥ 21 kV/mm  
**Cross linking time:**  
fast (about 10 min. at 25°C)  
**Volume resistivity:**  
>2 x 10<sup>14</sup> Ω cm  
**Operating temperature:**  
-60°C / +200°C  
**Overload temperature  
for short periods:**  
up to 250°C  
**Stabilised for:**  
mould-UV  
**Degree of protection:**  
IP68 (in proper casings)

IP68  
OFFICIALLY  
TESTED | IMQ

- For installations up to 1 kV
- Suitable for high temperatures
- Even suitable for high depths under water
- Waterproof > 1 MPa
- UV resistant
- Removable
- Vibration resistant  
can act as a damper
- Suitable for installation in  
salt water (sea) and in  
chlorinated water (pools)
- Non toxic and safe

EXTREMELY FLEXIBLE  
AND WATER-REPELLENT

NEW EXCEPTIONALLY  
STRONG CONSISTENCY

TECHNO  
**GELGUM**

FLEXIBLE LIKE GEL

STRONG LIKE RUBBER

BORN TO BE  
UNIQUE

Ray  
Tech

Not quite a GEL and not quite RUBBER,  
BUT HAS THE BEST FEATURES OF BOTH!



SAFE

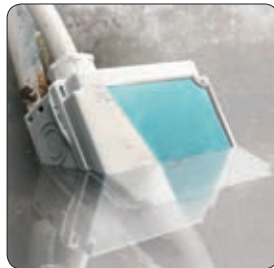

WATERPROOF



RE-ENTERABLE



Product	Colour	Package type	Quantity
Techno Gel Gum	●	1 single, bi-component bottle 1 small basin - 1 mixing spoon	1 kg
Techno Gel Gum 500	●	1 single, bi-component bottle 1 small basin - 1 mixing spoon	500 gr

Installation sequence



Shake before using.



Pour TechnoGelGum into the provided beaker in a 1:1 ratio.



Mix for 1 min. max.



Pour within 1 min. max.



In just 10 minutes the curing is completed.



Ray  
tech



# GelGum JOINT

Kit composed of 5 joint shells in fracture resistant plastic and 1 kg of Techno Gel Gum, bottled two-component waterproof and re-enterable insulation with very high dielectric, sealing and thermal characteristics. Techno Gel Gum is a strong flexible elastomer whose formula has been optimised for the protection of power cables, Telecom cables and electronic circuit connections. A new recipe that gives the product a surprising, original texture that combines the characteristics of gel and rubber to emphasise its features. It's elastic and flexible like gel, but also tough and dry like rubber.



## GelGum JOINT - L

*KIT for line joints*

art. **GELGUM JOINT-L**

*Kit composed of:*

- 1kg of Techno Gel Gum
- + 5 casings
- + a black 19x25, 0.13 mm-thick tape



Cable formation and conductor cross sections (n° x mm<sup>2</sup>)

	Cable formation and conductor cross sections (n° x mm <sup>2</sup> )			
	1x	2x	3x	4x
<b>4 L10 casings (180x50 mm)</b>	2,5 - 50	1,5 - 10	1,5 - 10	1,5 - 10
<b>1 L25 casing (215x55 mm)</b>	16 - 150	4 - 25	4 - 25	2,5 - 25

## GelGum JOINT - Y

*KIT for branch joints*

art. **GELGUM JOINT-Y**

*Kit composed of:*

- 1kg of Techno Gel Gum
- + 5 casings
- + a black 19x25, 0.13 mm-thick tape



Cable formation and conductor cross sections (n° x mm<sup>2</sup>)

	Cable formation and conductor cross sections (n° x mm <sup>2</sup> )							
	1x		2x		3x		4x	
	T	B	T	B	T	B	T	B
<b>4 LY6 casings (180x90 mm)</b>	4-50	4-50	4-10	4-10	2,5-6	2,5-6	2,5-6	2,5-6
<b>1 Y25 casing (220x105 mm)</b>	50-150	50-150	10-25	10-25	6-25	6-16	6-25	6-10

# Sky Plast

Bicomponent rubber in insulating, mouldable, self-extinguishing paste with high dielectric characteristics.

Thanks to Raytech's constant and careful research and development of new technologies comes Sky Plast, absolute technical innovation for covering, protecting, insulating, finishing and fireproofing any electrical and non-electrical component. Once the 2 components have been blended in a ratio of 1:1 (for max 2 min.) until uniform, it cross links quickly at room temperature in less than 5 minutes. After being wrapped around the component to be protected, Sky Plast quickly transforms into a layer of rubber with high dielectric and self-extinguishing characteristics.

- Mouldable, non-toxic and safe paste
- Low smoke and toxic and corrosive gases emission
- Able to replace taping, heat-shrinking, resin finishes
- Flexible and elastic
- Quickly ready for use

### Installation examples



Cable gland sealing

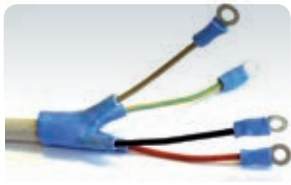

Creation of LV terminals

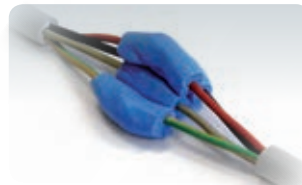

Insulation of multiple connections



Conduit protection



Drop line, bar, transformer through insulation

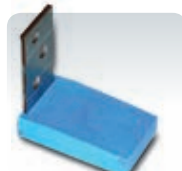

On-site preparation of braces and supports

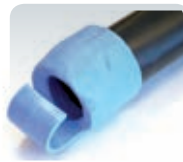

Preparation of deflectors, nozzles, flow deviators



Preparation on-site of expanders for inserts



Preparation on-site of small moulds for reliefs



Preparation of bars, washers, round wire insulators



Preparation on-site of seals

### Sky Plast

Product	Colour	Package type	Total quantity
Sky Plast	●	2 bicomponent cans	500 gr
Sky Plast 250	●	2 bicomponent cans	250 gr

**Dielectric strength:**  
> 23 kV/mm  
**Degree of protection:**  
IP68 (in proper casings)



### Installation sequence

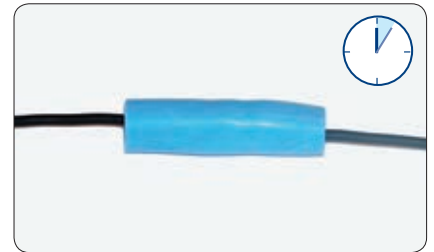
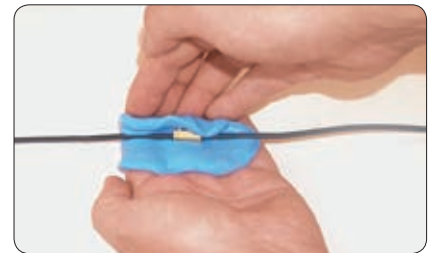

Raytech

# Magic Rubber

Fast cross linking bicomponent rubber.

Bicomponent insulating liquid rubber, extremely conformable and fluid, flexible, elastic and re-enterable. In just a few minutes, transforms into a rubber with very high dielectric, thermal, mechanical and elastic characteristics.

- Cross linking time:**  
15 minutes at 23°C
- Volume resistivity:**  
>2 10<sup>15</sup> Ω cm
- Dielectric strength:**  
> 23 kV/mm
- Specific weight:**  
1,22 approx
- Degree of protection:**  
IP68 (in proper casings)

- For installation up to 1kV
- Low smoke, toxic and corrosive gas emissions
- Ideal also for casts and moulds
- No shelf life



## Magic Rubber & Rubber Fluid

Product	Colour	Package type	Total quantity
Magic Rubber 500	●	2 bicomponent bottles 1 measuring cup - 1 mixing palette	500 gr
Magic Rubber 10	●	2 bicomponent tanks 1 measuring cup - 1 mixing palette	10 kg
Rubber Fluid 200	●	Bicomponent single dose bags	200 gr
Rubber Fluid 350	●	Bicomponent single dose bags	350 gr



Mix the 2 components in a ratio of 1:1.



Mix for max 30".



Pour the product into the casing to be filled.



In just a few minutes, the product transforms into rubber.



# Rayresin

Bicomponent epoxy resin for installations up to 1 kV.

Resin for electrical insulation and for the protection of thermosetting LV and MV accessories. The two components, the base resin and hardener, are mixed in close contact to trigger the cross linking reaction. Excellent bonding to metal, plastic and rubber components.



**Cross linking time:**

20 minutes at 20°C

**Hardness:**

70 Shore D

**Dielectric strength:**

21 kV/mm

**Specific weight:**

1,07 kg/dm<sup>3</sup>

1,7 kg/dm<sup>3</sup> for Rayresin Tan 3,8

**Water absorption:**

0,8% max



## Rayresin

Product	Colour	Package type	Total quantity
Rayresin 170	●	Bicomponent single dose bags	170 gr
Rayresin 210	●	Bicomponent single dose bags	210 gr
Rayresin 420	●	Bicomponent single dose bags	420 gr
Rayresin Tan 3,8	●	Tin with mineral charge	3.8 kg



Remove the separator from the Rayresin bag.



Mix the 2 components (30" max).

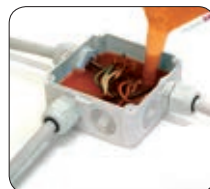

Pour Rayresin in the tray (1" max).



Installation completed.



# KIT IP68

Universal kits for branch or straight through connections complete with the appropriate amount of gel.

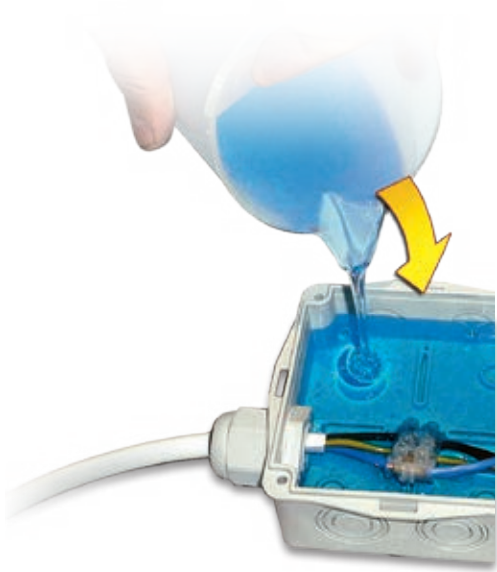

# Power Kit IP68 Solution

CONNECTION KIT WITH POWER GEL

page  
110



# Magic Box

CONNECTION KIT WITH MAGIC FLUID

page  
114





# Wonder Box

**New**

IP68 COMPLETE CONNECTION KIT  
ISOLATED WITH WONDER FLUID

page  
113



# J-Box

BRANCH KITS  
WITH HOOK CLOSING

page  
116



page  
117 Accessories

page  
118 Fittings

page  
119 J-Box - DIY







**Electrical Performance:**

CEI EN 60529

**Degree of protection:** IP68

Class 2 in accordance with CEI 64-8.

**Gel:** UL 94-HB

Operating temperature **90°**

Gel operating temperature **-60°C / +200°C**

**HF Halogen Free**

in accordance with CEI EN 50267 2-2

**IP68** OFFICIALLY TESTED **IMQ**

# Power Kit IP68

The only re-enterable and reusable IP68 kit. Can easily be used for ceiling mounted or recessed applications!

The most versatile, safe solution to fully protect connections in boxes with an IP68 degree of protection. Thanks to Magic Power, the newly developed, fast cross-linking, safe and reliable, extremely sticky self-agglomerating gel with very high dielectric, thermal and elastic characteristics, sealing is guaranteed in all type of installation, including submerged. The Power Kit IP68 solution is the only product of its kind! Not only because the insulation can be used in two different ways, both as a traditional "pour" in the box and as a "cross linked and sticky" product (cross linking first), but also because, thanks to its re-enterability and re-usability, it helps you save time and money!

- Kit complete with perfect IP68 connection
- Insulated with **Magic Power Gel** the innovative self-amalgamating gel
- Can also be used in severe environmental conditions
- Suitable for very high depths
- No waste
- No shelf life

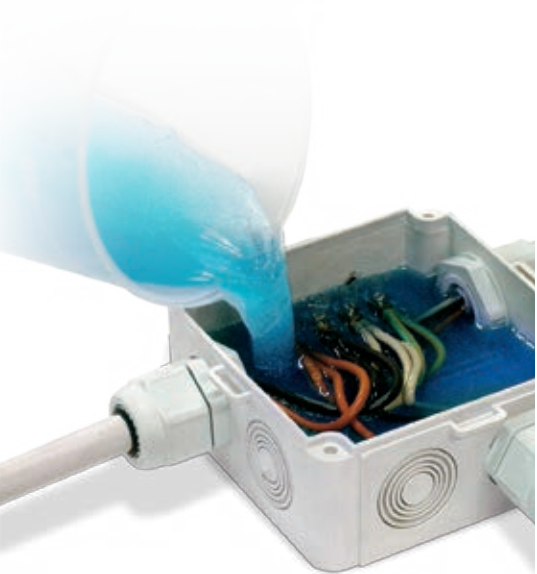

**WHERE CAN YOU USE THE POWER KIT?**

In pools, tanks, submerged pumps, outdoor lighting systems, underground, port piers, marinas, sewer systems, and with temporary connections such as with lights, street vendors, etc.

**HOW DO YOU USE THE POWER KIT?**

The insulation can be poured into the box (Pour!) or, for special applications, cross linked in the measuring beaker and applied around the connection (Stick!). Mix the Magic Power gel in a 1:1 ratio in the supplied measuring beaker. The gel will cross link in less than 15 minutes.

**NO WASTE**

The cross linked gel which remains on the bottom after mixing can be easily removed from the beaker and saved for later use.



Chose the **POUR** or **STICK** method most suited for your needs

**POUR**

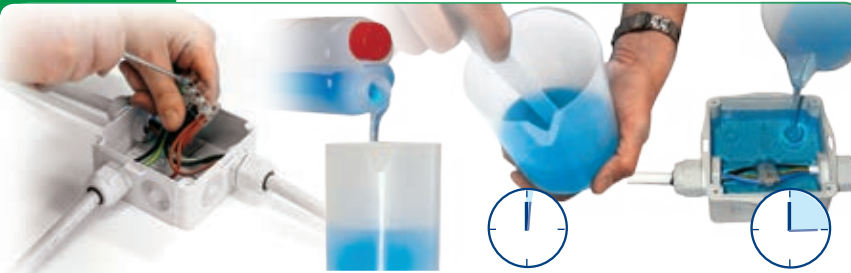

You can use the Magic Power gel supplied in the bicomponent bottle in a 1:1 ratio by simply pouring it after mixing into the box supplied in the kit, to protect and seal internal connections. The gel cross links in just 15 minutes, but the box can be energised immediately.

**RE-ENTER AND RE-USE**



Thanks to Magic Power Gel, the box can be **re-opened, inspected** and **re-insulated** all using the original installed product.

**STICK**



Pour the components in the measuring beaker, mix and leave to cross link (about 15 minutes). Remove the insulation and position it in small parts around the connection so that it is fully covered. Insulation saved from previous mixes can of course be utilised.

**IN A HURRY? ADVERSE WEATHER CONDITIONS? PREPARE YOUR INSULATION BEFORE INSTALLING IT!**

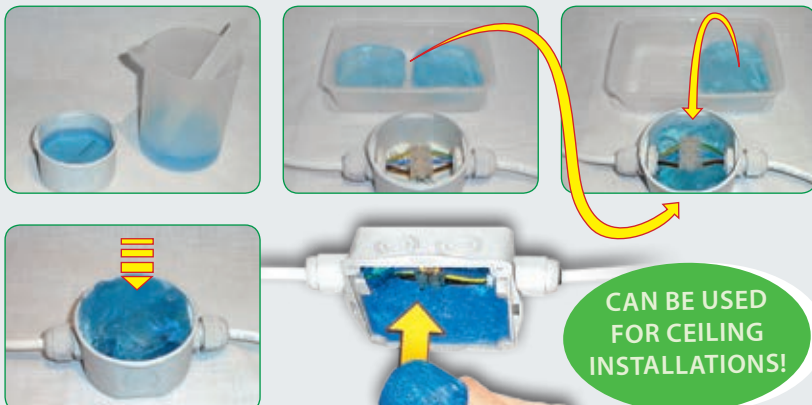



### WHAT ARE THE ADVANTAGES TO USING THE POWER KIT?

- The insulation is extremely sticky and self-amalgamating, with no shelf life, it is non-toxic and it adheres to everything while leaving your hands clean and dry.
- The kit does not cause waste: insulation left over in the measuring beaker can be saved for later use.
- Re-enterable and reusable, saving time and money.
- The supplied box has pre-marked holes.
- Compatible with Magic Gel.
- A slight exothermic reaction (temperature increase of about 3°C) speeds up cross linking in cold weather conditions.
- Even protects boxes mounted on the ceiling to IP68 if using the "stick" method. Could also use left over product from previous installations.
- Insulation can be pre-prepared: at home, at work or in your car and then applying it once cross linked, saving time when you're in a hurry or in adverse weather conditions.

### SOME LEFT OVER? SAVE IT!

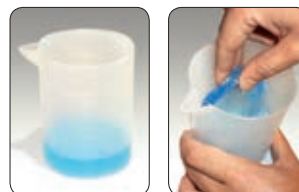

Left over gel that has already cross linked can be easily removed from the measuring beaker and saved for later use.



### Power Kit

Product	Box	Insulating
Power Kit 65	mm Ø 65 x h 35 + 2 cable glands PG16 / caps	Single bicomponent bottle 1 small basin - 1 mixing spoon
Power Kit 80	mm Ø 80 x h 40 + 3 cable glands PG16 / caps	Single bicomponent bottle 1 small basin - 1 mixing spoon
Power Kit 100	mm 100 x 100 x h 50 + 3 cable glands M25 x 1,5 / caps	Single bicomponent bottle 1 small basin - 1 mixing spoon
Power Kit 120	mm 120 x 80 x h 50 + 3 cable glands M25 x 1,5 / caps	Single bicomponent bottle 1 small basin - 1 mixing spoon



# Wonder Box IP68

## Complete IP68 connection kit insulated with Wonder Fluid.

Universal IP68 kit with no shelf life, mechanically robust, non-toxic, suitable for installation in even the most extreme conditions and re-enterable.

Protects from water, moisture, dust and accidental contact caused by insects.



**IP68**  
OFFICIALLY  
TESTED | **IMQ**

### WonderBOX 65

Cod. Wonder Box 65

2 box Ø 65 x h 35 mm

+

4 cable glands PG16 / caps

+

1 single component cartridge



### WonderBOX 80

Cod. Wonder Box 80

1 box Ø 80 x h 40 mm

+

3 cable glands PG16 / caps

+

1 single component cartridge



**Electrical Performance:**  
CEI EN 60529

**90°** Operating temperature

**Gel:** UL 94-HB

**🌡️** Gel operating temperature:  
-60°C / +200°C

**HF** Halogen Free

in accordance with  
CEI EN 50267 2-2





# Magic Box

**Electrical Performance:**  
CEI EN 60529

**Degree of protection:** IP68  
Class 2 in accordance  
with CEI 64-8.

**Gel:** UL 94-HB  US

Operating temperature  90°

Gel operating temperature   
-60°C / +200°C

**HF Halogen Free**

in accordance with  
CEI EN 50267 2-2

**IP68**  
OFFICIALLY  
TESTED 

IP68 Connection kit complete with Magic Fluid insulating gel.

Universal IP68 kit without shelf life, mechanically robust, non-toxic, suitable for installation even in the most extreme conditions, re-enterable, meeting all international standards. Protects from water, moisture, dust and accidental contact caused by small animals.

- Re-enterable even after long periods of operation
- Able to absorb external shock without fracturing
- For installations even at high depths
- Also suitable for vertical filling
- No shelf life
- Non toxic and safe



Magic Box is suitable for any kind of installation, even underground or directly submerged!



Magic Box is always re-enterable, even after long working periods!





Kit box installation sequence

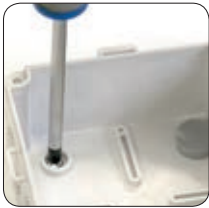

Fix the box and cover the screws with the caps.



Knock out the pre prepared holes.



Install the cable glands.



Insert the cables and connect the wires.

Horizontal installation sequence

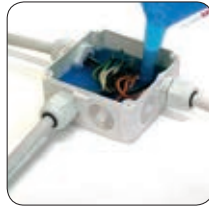

Vertical installation sequence



Examples of application

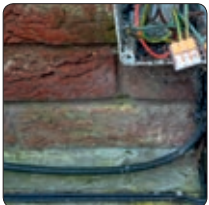

PUBLIC LIGHTING

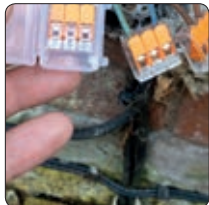

NAVAL SECTOR



OUTDOOR - GARDENS

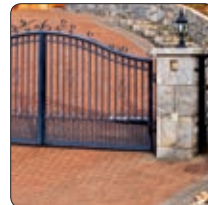

ELECTRIC GATES

Magic Box

Product	Max external Ø housed in input cables (mm)	N° and type of cable glands	Internal kit dimensions (mm)	Composition Kit
Magic Box 65	22	3 x PG16	Ø 65 x h 35	Kit complete with cover
Magic Box 80	22	3 x PG16	Ø 80 x h 40	
Magic Box 100	20	3 x M25 x 1.5	100 x 100 x h 50	3 cable glands
Magic Box 120	20	3 x M25 x 1.5	120 x 80 x h 50	Series of closing plugs
Magic Box 150	26	3 x M25 x 1.5	150 x 110 x h 70	Insulating gel for complete filling
Magic Box 190	26	3 x M25 x 1.5	190 x 140 x h 70	
Magic Box 240	26	3 x M25 x 1.5	240 x 190 x h 90	



**Ray  
tech**





# J-Box

Snap shut closing enclosures with perforated knockouts.

**Electrical Performance:**

CEI 23-48, IEC 60670

**Degree of protection:**

empty IP55  
filled with Gel Raytech IP68

**Halogen free:**

according to CEI EN 50267 2-2

**Self-extinguishing and resistant to abnormal heat and fire:**

Glow wire test a +960°C according to EN 60695-2-11

Enclosure with snap shut cover and perforated knockouts for faster mounting of cable glands. Very high mechanical and flame retardant properties. Non-toxic, re-enterable only by means of a tool. The screwless design prevents screws rusting over time due to moisture and always allows for easy re-entry. Screw caps are also supplied for the wall mounting screws along with 3 cable glands and a stopping plug for vertical filling.

- Can be insulated with **Magic Power Gel, Magic Gel, Wonder Gel (IP68)**
- Re-enterable only with the use of a tool
- Snap-shut closing (without screws)
- Also suitable for vertical filling
- Excellent shock-resistance
- Self-extinguishing
- Halogen Free

Snap-shut closing (without screws)



Pre - drilled walls

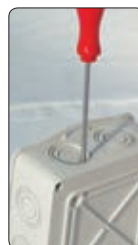



## J-Box

Enclosures with perforated knockouts.

Product	N° max of cables that can be jointed	Ø max predrilling holes (mm)	Ø max possible drilling (mm)	Max dimension housed cable glands (pass)		Dimension (mm)
				PG	METRIC	
J-BOX 65	4	23	23	16	20	Ø 65 x h 35
J-BOX 80	4	23	23	16	20	Ø 80 x h 40
J-BOX100	8	29	29	21	25	100 x 100 x h 50
J-BOX120	6	25	29	21	25	120 x 80 x h 50
J-BOX150	10	29	37	29	32	150 x 110 x h 70
J-BOX190*	10	37	37	29	32	190 x 140 x h 70
J-BOX240*	12	37	37	29	32	240 x 190 x h 90

\* Supplied with extractable hinge for opening book type.  
Note: All boxes include 3 cable glands Ray Pass 16.



## Accessories

### Ray-PRESS

Cable glands.

METRIC pict Product	Metric pict	Assembly hole Ø (mm)	Cable range Ø		Item packaging
			min (mm)	max (mm)	
Ray PRESS-16	M16 x 1.5	16	6	10	50
Ray PRESS-20	M20 x 1.5	20	8	13	50
Ray PRESS-25	M25 x 1.5	25	12	18	20
Ray PRESS-32	M32 x 1.5	32	16	20	20

PG pict Product	PG pitch	Assembly hole Ø (mm)	Cable range Ø		Item packaging
			min (mm)	max (mm)	
Ray PRESS-PG11	11	19	6	9	50
Ray PRESS-PG13.5	13,5	20	9	12	50
Ray PRESS-PG16	16	23	11	14	50
Ray PRESS-PG21	21	29	14	18	20



### Ray-PASS

Rubber flexible grommets.

Product	For pipe maximum external Ø (mm)	Assembly hole Ø (mm)	Item packaging
Ray PASS 16	20	23	50
Ray PASS 21	23,5	29	50
Ray PASS 29	32	38	50





# Connectors

**Temperature of use:**  
-5°C / +50°C  
**Insulation resistance:**  
> 100 MΩ  
**Reference standards:**  
CEI EN 50086-2-1

Self-extinguishing rigid PVC accessories  
V0 - Standard UL94.



## Ray RTC

Tube box connectors IP65 grey RAL 7035.

Product	Tube Ø (mm)	Item packaging
Ray RTC 16	16	50
Ray RTC 20	20	50
Ray RTC 25	25	50
Ray RTC 32	32	25
Ray RTC 40	40	20
Ray RTC 50	50	10



## Ray RGC

Box straight connectors IP65 grey RAL 7035.

Product	Tube Ø (mm)	Item packaging
Ray RGC 16	16	50
Ray RGC 20	20	50
Ray RGC 25	25	25
Ray RGC 32	32	25
Ray RGC 40	40	20
Ray RGC 50	50	10



## Ray CF

Flexible tube box bend IP65 grey RAL 7035.

Product	Tube Ø (mm)	Item packaging
Ray CF 16	16	70
Ray CF 20	20	60
Ray CF 25	25	50
Ray CF 32	32	30
Ray CF 40	40	20
Ray CF 50	50	10





# J-Box KIT IP68 - Do It Yourself

Choose the box, the cable glands and the filler shown in the selection table. In just 3 steps you have a specific IP68 box just for you!

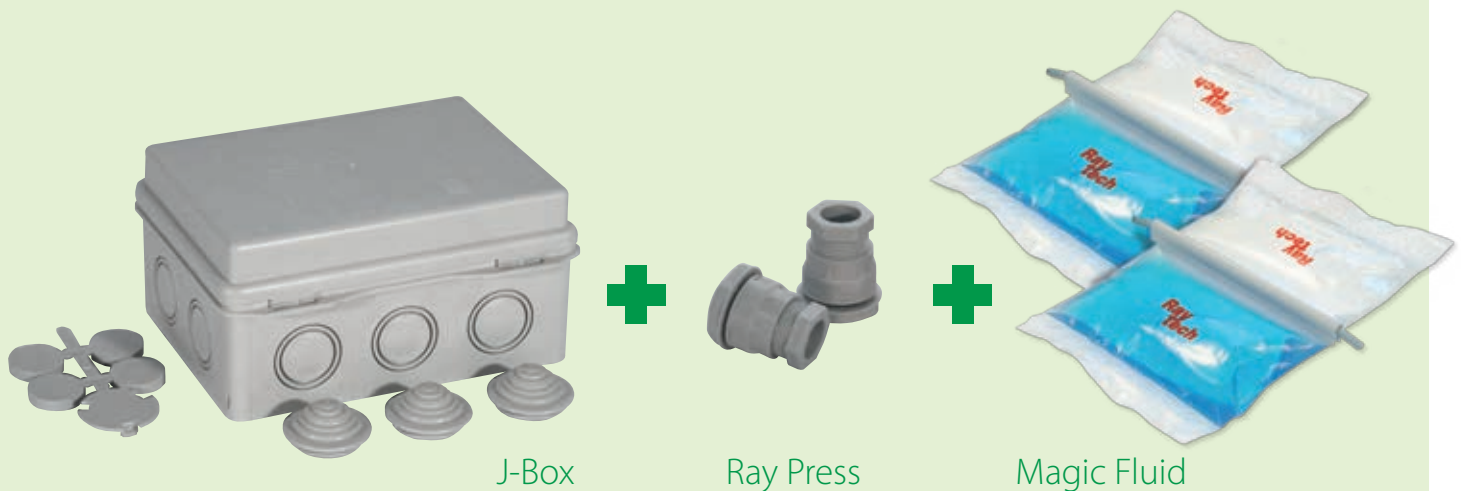

J-Box

Ray Press

Magic Fluid

Box type	Dimension (mm)	Type of cable glands to be housed PG and metric pitch M	Insulating filler Magic Fluid*
J-Box 65	Ø 65 x 35	PG: 7 - 9 - 11 - 13,5 - 16 M: 12 - 16 - 20	1 x Magic Fluid 110
J-Box 80	Ø 80 x 40	PG: 7 - 9 - 11 - 13,5 - 16 M: 12 - 16 - 20	1 x Magic Fluid 210
J-Box 100	100 x 100 x h 50	PG: 7 - 9 - 11 - 13,5 - 16 - 21 M: 12 - 16 - 20 - 25	1 x Magic Fluid 420
J-Box 120	120 x 80 x h 50	PG: 7 - 9 - 11 - 13,5 - 16 - 21 M: 12 - 16 - 20 - 25	1 x Magic Fluid 420
J-Box 150	150 x 110 x h 70	PG: 13,5 - 16 - 21 - 29 M: 20 - 25 - 32	2 x Magic Fluid 420
J-Box 190	190 x 140 x h 70	PG: 13,5 - 16 - 21 - 29 M: 20 - 25 - 32	2 x Magic Fluid 420 1 x Magic Fluid 550
J-Box 240	240 x 190 x h 90	PG: 13,5 - 16 - 21 - 29 M: 20 - 25 - 32	4 x Magic Fluid 550 + 2 x Magic Fluid 210

\*Note: the indicated quantities are for the complete filling of the box.



# SHEATHS

Thin, Medium, Heavy-wall  
heat shrink supplied in  
dispensers, coils, bars,  
wrap around and pieces.

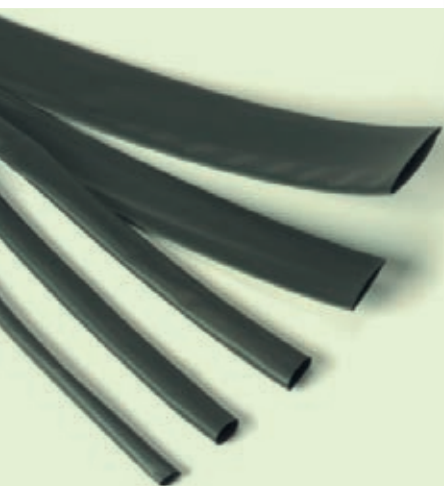



# Heat-shrink sheaths

## THIN-WALL

page  
122



**LST-TEC**  
Sheaths in dispensers  
for commercial use



**RayRoll / MaxiRoll**  
Sheaths in dispensers  
for industrial use

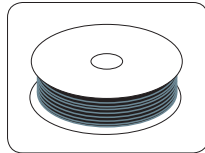

**CGP-TEC**  
Sheaths in coils  
or commercial use

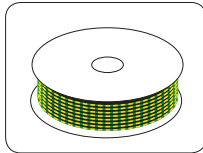

**DCP-TEC**  
Sheaths in coils  
for grounding cables



**RDCT-B**  
Tubes in bars  
for general use

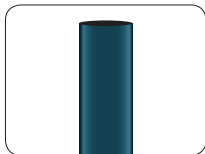

**RGPO-B**  
Tubes in bars  
for general use

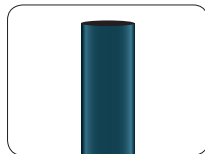

**Ray-Tum**  
Semi-flexible sheath  
in bars



**Thermo Mini Mix**  
Precut sheath kit

### MEDIUM WALL

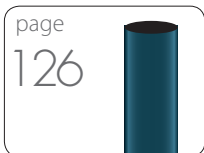

**MTR**

### HEAVY WALL

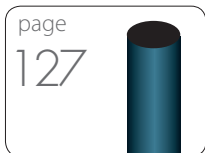

**Ray-CSM**

### WRAP AROUND



**Ray-RSM**  
Winding sheath

### POLE PROTECTION

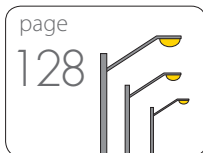

**WPC / LTSPM**  
Sheaths for  
lighting poles



### Colour table

- Black
- Red
- Blue
- Yellow
- White
- ⊙ Transparent
- Yellow Green

# Moulded parts

## CAPS

page  
129

### Self-sealing cap



## TERMINATIONS

page  
129

### LV terminations







Tensile resistance	14,8 MPa
Elongation	460 %
Tensile resistance after ageing	14,5*
Elongation after ageing	480 %*
Dielectric strength	17 kV/mm*
Flammability	VW1*
Minimum shrinkage temperature	70°C

\* (UL 224 test method)

# Thin-wall sheaths

Flexible heat-shrink modified polyolefin sheaths, cross linked by means of radiation. Longitudinal shortening up to 15%. Suitable for insulation and covering of conductors and their connections, bars. etc. Replace self-adhesive, self-amalgamating insulating tapes.

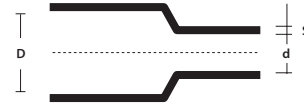

"UL" standard

Operating temperature: -55°C / +120°C

D = Ø min. before shrinkage

d = Ø max. after free shrinkage

S = min. rated thickness after free shrinkage



## LST-TEC

Heat-shrink in dispensers for commercial use.

Product	Colour	D (mm)	d (mm)	S (mm)	Length (m)
LST-TEC 1,6	● ●	1,6	0,8	0,50	10
LST-TEC 2,4	● ●	2,4	1,2	0,55	10
LST-TEC 3,2	● ●	3,2	1,6	0,55	10
LST-TEC 4,8	● ●	4,8	2,4	0,55	9
LST-TEC 6,4	● ●	6,4	3,2	0,65	8
LST-TEC 9,5	● ●	9,5	4,8	0,65	6
LST-TEC 12,7	● ●	12,7	6,4	0,65	6
LST-TEC 19,0	● ●	19,0	9,5	0,80	5
LST-TEC 25,4	● ●	25,4	12,7	0,95	3
LST-TEC-GV 3/1,5	● ●	3	1,5	0,51	7
LST-TEC-GV 4,8/2,4	● ●	4,8	2,4	0,55	10
LST-TEC-GV 6/3	● ●	6	3	0,58	5
LST-TEC-GV 10/5	● ●	10	5	0,64	4
LST-TEC-GV 12/6	● ●	12	6	0,65	7
LST-TEC-GV 19/9	● ●	19	9	0,74	3
LST-TEC-GV 26/13	● ●	26	16	0,89	2,5



## Ray Roll

Heat-shrink in dispensers for industrial use.

Product	Colour	D (mm)	d (mm)	S (mm)	Length (m)
Ray Roll 1,6	●	1,6	0,8	0,50	20
Ray Roll 2,4	●	2,4	1,2	0,55	20
Ray Roll 3,2	●	3,2	1,6	0,55	10
Ray Roll 4,8	●	4,8	2,4	0,55	10
Ray Roll 6,4	●	6,4	3,2	0,65	10
Ray Roll 9,5	●	9,5	4,8	0,65	10
Ray Roll 12,7	●	12,7	6,4	0,65	10
Ray Roll 19,0	●	19,0	9,5	0,80	5
Ray Roll 25,4	●	25,4	12,7	0,95	5

## Maxi Roll

Heat-shrink in maxi dispensers for industrial use.

Product	Colour	D (mm)	d (mm)	S (mm)	Length (m)
Maxi Roll 1,6	●	1,6	0,8	0,50	300
Maxi Roll 2,4	●	2,4	1,2	0,55	300
Maxi Roll 3,2	●	3,2	1,6	0,55	300
Maxi Roll 4,8	●	4,8	2,4	0,55	150
Maxi Roll 6,4	●	6,4	3,2	0,65	75
Maxi Roll 9,5	●	9,5	4,8	0,65	150
Maxi Roll 12,7	●	12,7	6,4	0,65	150
Maxi Roll 19,0	●	19,0	9,5	0,80	75
Maxi Roll 25,4	●	25,4	12,7	0,95	60



## CGP-TEC

Sheath for commercial use.

Product	Colour	D (mm)	d (mm)	S (mm)	Spool (m)
CGP-TEC 1,2/0,6	●●●●○Ⓟ	1,2	0,6	0,45	600
CGP-TEC 1,6/0,8	●●●●○Ⓟ	1,6	0,8	0,45	300
CGP-TEC 2,4/1,2	●●●●○Ⓟ	2,4	1,2	0,50	300
CGP-TEC 3,2/1,6	●●●●○Ⓟ	3,2	1,6	0,50	300
CGP-TEC 4,8/2,4	●●●●○Ⓟ	4,8	2,4	0,50	150
CGP-TEC 6,4/3,2	●●●●○Ⓟ	6,4	3,2	0,65	75
CGP-TEC 9,5/4,8	●●●●○Ⓟ	9,5	4,8	0,65	150
CGP-TEC 12,7/6,4	●●●●○Ⓟ	12,7	6,4	0,65	150
CGP-TEC 19/9,5	●●●●○Ⓟ	19,0	9,5	0,75	75
CGP-TEC 25,4/12,7	●●●●○Ⓟ	25,4	12,7	0,90	60
CGP-TEC 38/19	●●●●○Ⓟ	38,0	19,0	1,00	60
CGP-TEC 51/26	●●●●○Ⓟ	51,0	26	1,15	30
CGP-TEC 76/38	●●●●○Ⓟ	76,0	38,0	1,27	15
CGP-TEC 102/51	●●●●○Ⓟ	102,0	51,0	1,40	15

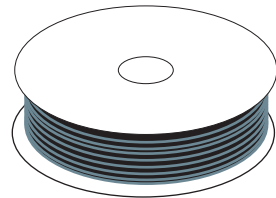

## DCP-TEC

Sheath suitable for coating grounding cables.

Product	Colour	D (mm)	d (mm)	S (mm)	Spool (m)
DCP-TEC 3/1,5	●●	3,0	1,5	0,51	300
DCP-TEC 6/3	●●	6,0	3,0	0,58	75
DCP-TEC 10/5	●●	10,0	5,0	0,64	75
DCP-TEC 12/6	●●	12,0	6,0	0,64	75
DCP-TEC 19/9	●●	19,0	9,0	0,74	75
DCP-TEC 26/13	●●	26,0	13,0	0,89	30
DCP-TEC 38/19	●●	38,0	19,0	1,00	30

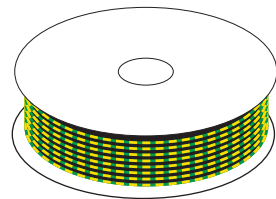



Minimum shrinkage temperature **125°**

Operating temperature: **-55°C / +125°C**

Tensile resistance	14,8 MPa
Elongation	460 %
Tensile resistance after ageing	14,5*
Elongation after ageing	480 %*
Dielectric strength	17 kV/mm*
Flammability	VW1*

\* (UL 224 test method)

## Sheaths in bars

Flexible heat-shrink modified polyolefin sheaths, cross linked by means of radiation. Longitudinal shortening up to 15%. Suitable for insulation and covering of conductors and their connections, bars. etc. Replace self-adhesive, self-amalgamating insulating tapes.

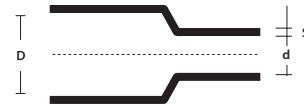
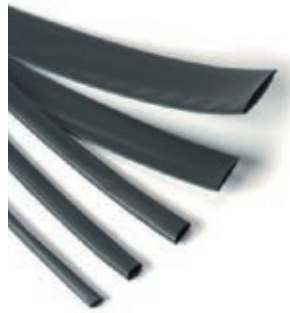

D = Ø min. before shrinkage

d = Ø max. after free shrinkage

S = min. rated thickness after free shrinkage

## RDCT-B

Yellow green tube for general use in bars.



Product	Colour	D (mm)	d (mm)	S (mm)	Bars (m)
RDCT-B 3/1,5		3,0	1,5	0,51	1,2
RDCT-B 6/3		6,0	3,0	0,58	1,2
RDCT-B10/5		10,0	5,0	0,64	1,2
RDCT-B 12/6		12,0	6,0	0,64	1,2
RDCT-B 19/9		19,0	9,0	0,74	1,2
RDCT-B 26/13		26,0	13,0	0,89	1,2

## RGPO-B

Tube for general use in bars.



Product	Colour	D (mm)	d (mm)	S (mm)	Bars (m)
RGPO-B 2,4/1,2		2,4	1,2	0,50	1,2
RGPO-B 3,2/1,6		3,2	1,6	0,50	1,2
RGPO-B 4,8/2,4		4,8	2,4	0,50	1,2
RGPO-B 6,4/3,2		6,4	3,2	0,65	1,2
RGPO-B 9,5/4,8		9,5	4,8	0,65	1,2
RGPO-B 12,7/6,4		12,7	6,4	0,65	1,2
RGPO-B 19/9,5		19,0	9,5	0,75	1,2
RGPO-B 25,4/12,7		25,4	12,7	0,90	1,2
RGPO-B 38/19		38,0	19,0	1,00	1,2
RGPO-B 51/26		51,0	26	1,15	1,2





# Ray-TUM

Sheaths in bars with adhesive.

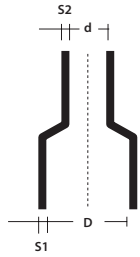

D = Ø min. before shrinkage  
 d = Ø max. after free shrinkage  
 S1 = rated thickness as supplied  
 S2 = min. rated thickness after free shrinkage

Shrinkage ratio 3:1						
Product	Colour	D (mm)	d (mm)	S <sub>2</sub> (mm)	S <sub>1</sub> (mm)	Bars (m)
Ray-TUM-3/1-0	●	3	1	1,00	0,5	1,2
Ray-TUM-6/2-0	●	6	2	1,00	0,5	1,2
Ray-TUM-9/3-0	●	9	3	1,40	0,6	1,2
Ray-TUM-12/4-0	●	12	4	1,75	0,7	1,2
Ray-TUM-19/6-0	●	19	6	2,25	0,8	1,2
Ray-TUM-24/8-0	●	24	8	2,50	1,0	1,2
Ray-TUM-40/13-0	●	40	13	2,50	1,0	1,2

Shrinkage ratio 4:1						
Product	Colour	D (mm)	d (mm)	S <sub>2</sub> (mm)	S <sub>1</sub> (mm)	Bars (m)
Ray-TUM-4/1-0	●	4	1	1,00	0,5	1,2
Ray-TUM-8/2-0	●	8	2	1,00	0,5	1,2
Ray-TUM-12/3-0	●	12	3	1,40	0,6	1,2
Ray-TUM-16/4-0	●	16	4	1,75	0,7	1,2
Ray-TUM-24/6-0	●	24	6	2,25	0,8	1,2
Ray-TUM-32/8-0	●	32	8	2,50	1,0	1,2
Ray-TUM-52/13-0	●	52	13	2,50	1,0	1,2



125° Minimum shrinkage temperature

Operating temperature: -55°C / +120°C

Tensile resistance	ISO 37	9 MPa (min)
Elongation	ISO 37	300 % (min)
Internal wall adhesion	-	60 N x 25 mm (min)
Thermal shock	4 h at 225°C	No-drip No breaking
Thermal ageing	168 h at 225°C	No-drip No breaking
Flexibility at low temperature	4 h at -55°C	No breaking
Dielectric strength	IEC 243	12 MV/m (min)
Resistance to fluids (lubricant oil, hydraulic fluid, diesel)	ISO 37	Tensile resistance 7 Mpa (min)
	24 h	Elongation: 300% (min)
	at 23°C	Adhesion to int. walls: 60 N x 25 mm (min)

# Thermo Mini Mix

Pre-cut heat-shrink sheaths kit.

Ready-for-installation heat-shrink sheaths in a practical, convenient kit sub-divided by diameter. Indispensable for Electrical systems, as a replacement for taped insulation, wiring of all types, switchboards, Hi-Fi, hobbies, DIY.

- Wide range of diameters and colours
- Always ready, quick application
- Flexible



COLOUR BLACK	MIXED COLOURS	Ø before and after shrinkage (mm)	Length of sheath (mm)	Pieces in the kit
Product	Product			
Thermo Mini Mix-N	Thermo Mini Mix-MC	1,0 / 0,5	97	60
		2,0 / 1,0	97	40
		3,0 / 1,5	97	30
		4,5 / 2,25	97	20
		6,0 / 3,0	97	10
		9,0 / 4,5	97	10



125° Minimum shrinkage temperature

Operating temperature: -55°C / +120°C





Minimum shrinkage temperature **125°**

Operating temperature: **-55°C / +125°C**

**HF** Halogen Free

Tensile resistance	14,8 MPa
Elongation	460 %
Tensile resistance after ageing	14,5*
Elongation after ageing	480 %*
Dielectric strength	17 kV/mm*

\* (UL 224 test method)

# Medium-wall sheaths

Heat-shrink modified polyolefin sheaths, cross linked by means of radiation for insulation, sealing and LV component protection. It is in fact used for restoring insulation and for the outer covering of LV cables and wherever optimal mechanical characteristics are required for resistance to impact, abrasion, general weathering including UV radiation, or for use in under water environments. Used for the insulation of bars or naked LV connections with optimal mechanical resistance for sealing, especially if used with hot-melt adhesive, and for anti-corrosion protection. Also replaces self-adhesive and self-amalgamating tapes.

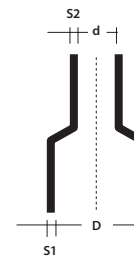

**D** = Ø min. before shrinkage  
**d** = Ø max. after free shrinkage  
**S1** = rated thickness as supplied  
**S2** = min. rated thickness after free shrinkage

## MTR

### WITH OR WITHOUT ADHESIVE

Product	Applications by diameters from (mm)	to (mm)	D (mm)	d (mm)	S <sub>1</sub> (mm)	S <sub>2</sub> (mm)
MTR 10/3*	3,5	9,0	10	3	0,3	1,0
MTR 16/5*	5,5	14,0	16	5	0,3	1,4
MTR 25/8*	8,5	22,0	25	8	0,4	2,0
MTR 35/12*	13,0	32,0	35	12	0,4	2,0
MTR 50/16*	17,5	45,0	50	16	0,5	2,0
MTR 63/19*	21,0	57,0	63	19	0,6	2,4
MTR 75/22*	24,0	68,0	75	22	0,6	2,7
MTR 85/25*	28,0	77,0	85	25	0,6	2,8
MTR 95/29*	32,0	86,0	95	29	0,7	3,1
MTR 115/34*	37,0	104,0	115	34	0,7	3,1
MTR 140/42*	46,0	126,0	140	42	0,7	3,1
MTR 160/55*	55,0	144,0	160	55	0,7	3,2
MTR 180/60*	66,0	162,0	180	60	0,7	3,2

\* Complete the item code adding the length (in mm), adhesive (/172) or without adhesive (/U).

## MTN

### Suitable for submersible pumps

#### WITH ADHESIVE

Product	Applications by diameters from (mm)	to (mm)	D (mm)	d (mm)	S <sub>1</sub> (mm)	S <sub>2</sub> (mm)
MTN 10/3*	3,5	9,0	10	3	0,3	1,0
MTN 16/5*	5,5	14,0	16	5	0,3	1,4
MTN 25/8*	8,5	22,0	25	8	0,4	2,0
MTN 35/12*	13,0	32,0	35	12	0,4	2,0
MTN 50/16*	17,5	45,0	50	16	0,5	2,0
MTN 63/19*	21,0	57,0	63	19	0,6	2,4
MTN 75/22*	24,0	68,0	75	22	0,6	2,7
MTN 85/25*	28,0	77,0	85	25	0,6	2,8
MTN 95/29*	32,0	86,0	95	29	0,7	3,1
MTN 115/34*	37,0	104,0	115	34	0,7	3,1

\* Complete the item code adding the length (in mm).



# Heavy-wall sheaths

RAY-CSM heat-shrink tubular sheath is very thick and has been designed for uses requiring exceptional mechanical characteristics. Its ideal field of application is in underwater or directly underground environments, or where exceptional resistance to abrasion and impact is required, but also outstanding resistance to weathering, including UV radiation, for sealing, especially if used with hot-melt adhesive, and for anti-corrosion protection.

## Ray-CSM

Product	Applications by diameters		D	d	S <sub>1</sub>	S <sub>2</sub>
	from (mm)	to (mm)	(mm)	(mm)	(mm)	(mm)
Ray-CSM 12/3*	3,5	10	12	3	0,8	2,0
Ray-CSM 16/4*	4,5	14	16	4	0,9	2,4
Ray-CSM 24/6*	6,5	22	24	6	1,0	2,7
Ray-CSM 34/8*	9	31	34	8	1,3	4,0
Ray-CSM 48/12*	13	44	48	12	1,5	4,5
Ray-CSM 56/16*	17,5	50	56	16	1,5	4,4
Ray-CSM 70/21*	22	63	70	21	1,4	4,4
Ray-CSM 90/25*	27	81	90	25	1,3	4,3
Ray-CSM 110/30*	33	100	110	30	1,2	4,3
Ray-CSM 130/36*	38	118	130	36	1,2	4,3
Ray-CSM 160/50*	55	144	160	50	1,0	4,3
Ray-CSM 180/50*	55	162	180	50	1,0	4,3

\* Complete the item code adding the length (mm), adhesive (/172).

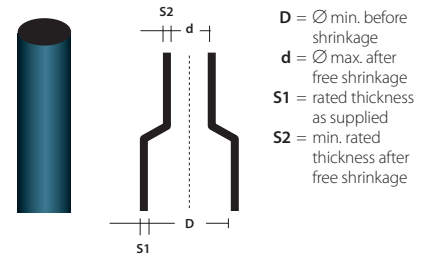

**125°** Minimum shrinkage temperature

**U** Operating temperature: -55°C / +120°C

**HF** Halogen Free

Tensile resistance	ISO 37	12 MPa (min)
Elongation	ISO 37	350 % (min)
Thermal duration	IEC 60216	120°C
Dielectric strength	IEC 60243	1 mm wall
		180 kV/cm
		3.5 mm wall
		120 kV/cm

# Wrap Around

Winding heat-shrink sheath for repairing plastic or metal cable sheaths. It combines the previously seen mechanical, protective and sealing properties of tubular junctions with easy of application and closing. Indispensable when cable cutting is not possible. Does not require pre-insertion, reducing the space necessary for its application.

## Ray-RSM

Product	Ø cable		D	d
	from (mm)	to (mm)		
Ray-RSM 34/10*	12	21	34	10
Ray-RSM 53/13*	15	32	53	13
Ray-RSM 84/20*	23	50	84	20
Ray-RSM 107/29*	34	65	107	29
Ray-RSM 143/36*	42	86	143	36
Ray-RSM 198/55*	62	120	198	55
Ray-RSM 250/98*	111	150	250	98

\* Complete the item code adding the length (mm) and adhesive (/232).

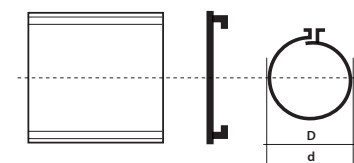

D = Ø minimum before shrinkage  
d = Ø maximum after free shrinkage

**HF** Halogen Free

Tensile resistance	ISO 37	17 MPa (min)
Elongation	ISO 37	350 % (min)
Density	ISO 1183	1,0-1,2 g/cm <sup>3</sup>
Hardness	ISO 868	50-70 Shore D
Thermal duration	IEC 60216	120°C
Flexibility at low temperature	4 h at -40°C ASTM D2671	Non-cracking
Dielectric strength	IEC 60243	1 mm wall
		180 kV/cm
		3.5 mm wall
		120 kV/cm

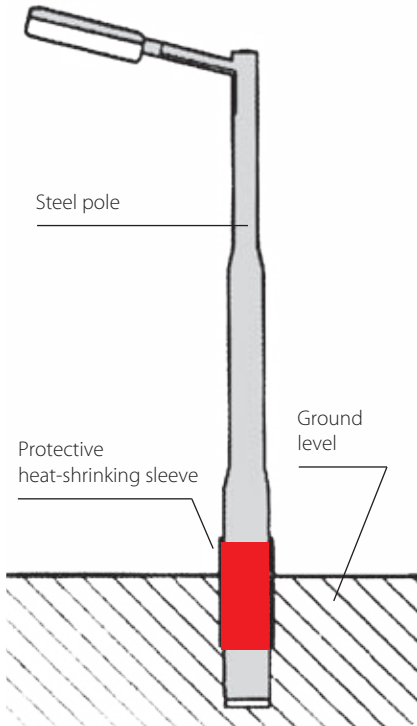

## Anti-corrosion pole protection

On installed poles, the most section vulnerable to corrosion is right above and below ground. This section is attacked by corrosive agents that cause a rapid decay of the metal with a significant reduction of the operating life of the pole. Special heat-shrinking sheaths are suitable for the rust protection of public lighting and electric traction poles, traffic lights and traffic signs. They are composed of very thick cross linked polyolefin. The inside of the tubes and the ends are covered in a suitable thermal fuse adhesive that ensures perfect sealing without allowing moisture to enter.

- Ultra adhesive
- Excellent electrical properties
- Good chemical resistance
- Resistant to mould and micro-organisms
- Constant protection against stray electrical currents
- Easy application
- Long-term stability of all properties



## WPCT

Open ends complete with closing pieces for already installed poles.

Product	End height (mm)	Package roll (m)	Code for closing piece for pole diameter	
			Up to 450 mm	Over 450 mm
WPCT-17X100-RL	450	30	WPCP-IV-4X17	WPCP-IV-6X17
WPCT-24X100-RL	600	30	WPCP-IV-4X24	WPCP-IV-6X24

Closing pieces sold separately



## LTPSM

Tubular sleeve for poles for installation.

Product	Diameter before/after shrinkage (mm)	Sleeve length (mm)
LTPSM 180/58-500	180/58	500
LTPSM 245/80-500	245/80	500





# Self-sealing cap

Self-sealing heat-shrink cap with adhesive for sealing cable heads.

Product	Ø cable		D (mm)	d (mm)	S (±20% mm)	L1 (±10% mm)
	from (mm)	to (mm)				
RayL011	4	8	12	4,0	2,0	40
RayL022	8	17	20	6	2,3	55
RayL033	17	30	35	16	3,0	83
RayL044	30	45	55	26	3,3	103
RayL048	45	65	75	36	3,3	120
RayL055	65	95	100	52	3,8	140
RayL066	95	115	120	60	3,8	150

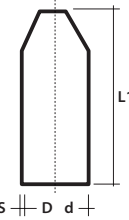

D = Ø min. before shrinkage  
d = Ø max. after free shrinkage  
S-L1 = min. rated size after free shrinkage



## HF Halogen Free

Tensile resistance	ISO 37	12 MPa (min)
Elongation	ISO 37	200 % (min)
Density	ISO 1183	0,9-1,2 g/cm <sup>3</sup>
Hardness	ISO 868	50-70 Shore D
Accelerated ageing (7 days at 150°C) ISO 188	Tensile resistance ISO 37	12 MPa (min)
	Ultimate elongation ISO 37	200% (min)
Flexibility at low temperature	4 h at -40°C ASTM D2671	Non-cracking
Water absorption	ISO 62	0,5% max after 24 h at 23°C

# Self-sealing termination

Product	LV cable conductor (mm <sup>2</sup> )		D1 (mm)	d1 (mm)	S1 ±20% (mm)	D2 (mm)	d2 (mm)	S2 ±20% (mm)	L1 ±10% (mm)	L2 ±10% (mm)
	from	to								
RayK333	4	16	22	8	2	9	3,5	2	55	18
RayK224	25	70	40	16	2	15	7,5	2	125	35
RayK466	95	185	60	23	2,5	25	7,5	2,5	155	45

Product	LV cable conductor (mm <sup>2</sup> )		D1 (mm)	d1 (mm)	S1 ±20% (mm)	D2 (mm)	d2 (mm)	S2 ±20% (mm)	L1 ±10% (mm)	L2 ±10% (mm)
	from	to								
RayW533	4	35	38	17	2,7	14	4,5	2,5	98	23
RayW516	50	150	60	25	3	25	8	2,5	165	50
RayW526	185	300	80	38	3,5	35	11	3,5	185	55
RayW248	185	500	110	50	4,0	46	17,5	3,5	250	65

Product	LV cable conductor (mm <sup>2</sup> )		D1 (mm)	d1 (mm)	S1 ±20% (mm)	D2 (mm)	d2 (mm)	S2 ±20% (mm)	L1 ±10% (mm)	L2 ±10% (mm)
	from	to								
RayK033	4	35	42	15	2,3	14	3,5	1,9	105	26
RayK046	50	70	55	21	3,1	20	5	2,5	150	40
RayK016	95	150	65	26	3,5	26	7	2,9	175	45
RayK026	185	300	102	47	3,9	38	12	3	198	58

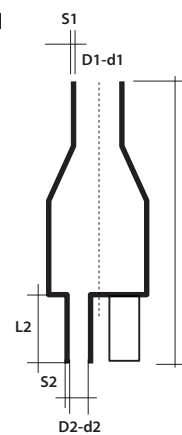

D = Ø min. before shrinkage  
d = Ø max. after free shrinkage  
S1 / S2 = min. rated size after free shrinkage  
L1 / L2 = min. rated size after free shrinkage

## HF Halogen Free

Tensile resistance	ISO 37	10,5 MPa (min)
Elongation	ISO 37	300 % (min)
Density	ISO 1183	10-1,3 g/cm <sup>3</sup>
Hardness	ISO 868	50-70 Shore D
Accelerated ageing (7 days at 150°C) ISO 188	Tensile resistance ISO 37	8,5 Mpa (min)
	Ultimate elongation ISO 37	100% (min)
Flexibility at low temperature	4 h at -40°C ASTM D2671	Non-cracking
Water absorption	ISO 62	0,5% max after 14 days at 23°C



# Insulation tapes

## SELF-ADHESIVE TAPES IN PVC

page  
132



**Rayteam**  
Self-adhesive for general use



**Raytech Super 3-3**  
Self-adhesive for low and high temperatures

**Raytech 2-2**  
Heavy duty self-adhesive

## SELF-AMALGAMATING

page  
134



**Raytech 2.3**  
Insulation tape EPR



**Raytech 23 BT**  
LV insulation tape

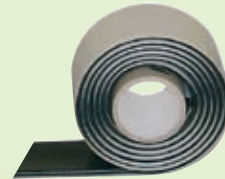

**Raytefill**  
Heavy duty insulation tape



**Raytech 7-0**  
Silicone insulation tape





SPECIAL TAPES

page  
136



MCA-FV  
Fibreglass self-adhesive  
tape



Raycopper  
Copper braid tape

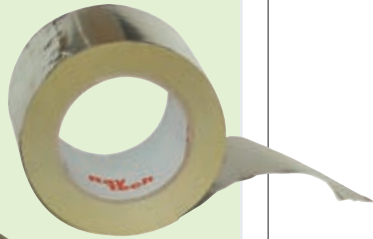

MCA-ALL  
Self-adhesive  
aluminium tape





## Approvals

## Complies with standards

UL 510 - CEI 15-15  
CEI 60454 (EN60454)

## VDE marking



## Rayteam

Self-adhesive for general use.

PVC adhesive tape for electrical applications and mechanical protection for general use. Recommended for insulating low-voltage joints and for covering cables, accessories and products in general. It is self-extinguishing and does not propagate fire. Excellent resistance to ageing, exposure to weather conditions, hydrocarbons and chemical solvents in general.

## 0,13 mm

Product	Width	Thickness	Length
Rayteam 1925/13	19 mm	0,13 mm	25 m
Rayteam 1510/13	15 mm	0,13 mm	10 m

## 0,15 mm

Rayteam 1925	19 mm	0,15 mm	25 m
Rayteam 1510	15 mm	0,15 mm	10 m
Rayteam 2525*	25 mm	0,15 mm	25 m
Rayteam 1525	15 mm	0,15 mm	25 m



Available colours: black, grey, white, red, blue, brown, yellow/green.

\* only black, white and grey. Contact Raytech for other sizes and thicknesses.

Property	Test method	Typical values
Breaking Strength (tensile)	ASTM-D-1000	65N/25 mm width min
Elongation at break	ASTM-D-1000	> 200 %
Adhesion to steel	ASTM-D-1000	6 N/25 mm width
Adhesion to backing	ASTM-D-1000	6 N/25 mm width
Self-extinguishing	ASTM-D-1000	self ext. 4 max
Operating temperature	UL 510	-5°C / 85°C
Electric strength after exposure to damp environment	ASTM-D-1000	40 kV/mm min





## Raytech Super 3-3

Self-adhesive for use at low and high temperatures.

PVC adhesive tape with excellent electrical and mechanical properties for a wide range of working temperatures. This tape is particularly suitable for use at low temperatures and in all weather conditions, including the most extreme. The tape is flame retardant and self-extinguishing. It is recommended as the primary insulation for joints up to 0.6/1 kV, and as the outer covering for joints and other products, and for all applications at low temperatures.

Product	Colour	Width	Thickness	Length
Raytech Super 3-3	●	19 mm	0,18 mm	20 m

Property	Test method	Typical values
Breaking Strength (tensile)	ASTM-D-1000	80N/25 mm width min
Elongation at break	ASTM-D-1000	240% min
Adhesion to steel	ASTM-D-1000	>7 N/25 mm width
Adhesion to backing	ASTM-D-1000	>7 N/25 mm width
Adhesion to backing at -7°C	ASTM-D-1000	>18 N/25 mm width
Self-extinguishing	ASTM-D-1000	self ext. 4 max
Operating temperature	CSA-22.2	-18°C / 105°C
Electric Strength after exposure to damp environment	ASTM-D-1000	51 kV/mm min



### Approvals

UL 510  
CSA 22.2  
ASTMD-3005  
HH-I-595C  
CEI15-15  
CEI 60454 (EN60454)

## Raytech 2-2

Heavy duty thickness auto-adhesive.

PVC adhesive tape for electrical and mechanical purposes even in the most severe conditions (0.25 mm. thick). Particularly suitable for insulating and protecting cables, accessories and other products against adverse weather conditions and industrial solvents, and as a primary low voltage joint insulation. It is self-extinguishing and non flame-propagating. It has excellent wear resistance, even when it is installed and working under very severe conditions.

Product	Colour	Width	Thickness	Length
Raytech Super 2-2	●	19 mm	0,25 mm	20 m

Property	Test method	Typical values
Breaking Strength (tensile)	ASTM-D-1000	125N/25 mm width min
Elongation at break	ASTM-D-1000	>200 %
Adhesion to steel	ASTM-D-1000	>6 N/25 mm width
Adhesion to backing	ASTM-D-1000	>6 N/25 mm width
Self-extinguishing	ASTM-D-1000	self ext. 4 max
Working temperature maximum	CSA-22.2	105°C
Operating temperature	UL 510	-10°C
Electric strength after exposure to damp environment	ASTM-D-1000	40 kV/mm min



### Approvals

UL 510  
CSA 22.2  
ASTM-D-2301  
MIL-I-7798A  
CEI 15-15  
CEI 60454 (EN60454)



Approvals  
ASTM-D-4388  
HH-I-553C/Grade A  
MIL-I-3825 B

## Raytech 2.3

EPR Self-amalgamating low and high voltage tape.

This ethylene-propylene (EPR) self-amalgamating tape is used for insulating and sealing high voltage electrical joints for voltages up to Um 72 kV. It amalgamates rapidly, adapting itself to the product underneath, forming a solid unit without air bubbles. It is particularly resistant to partial discharges (corona), with the characteristics remaining unchanged with time. Joints must be protected with a PVC tape or similar.

Product	Colour	Width	Thickness	Length
Raytech 2.3	●	19 mm	0,76 mm	9 m

Property	Test method	Typical values
Breaking Strength (tensile)	ASTM-D-4325	2.8 MPa min
Elongation at break	ASTM-D-4325	800% min
Amalgamation ability	ASTM-D-4325	2,0 mm
Overload temperature	ASTM-D-4388	130°C
Operating temperature	ASTM-D-4388	90°C
Dielectric strength	ASTM-D-4325	35 kV/mm min
Relative dielectric constant	ASTM-D-4325	2.7
Volume resistivity	ASTM-D-4325	10 <sup>15</sup> Ω cm min
Resistance to ozone	ASTM-D-4325	Positive
Resistance to U.V.	ASTM-D-4325	Positive



Approvals  
UL 510

## Raytech 23 BT

Low voltage Self-amalgamating tape.

This rubber self-amalgamating low voltage tape (0.6/1 kV) is used for insulating and sealing low voltage electrical joints. It amalgamates rapidly, adapting itself to the product underneath, forming a solid unit. The joints must be protected with a PVC tape. The characteristics remain unchanged with time.

Product	Colour	Width	Thickness	Length
Raytech 23 BT	●	19 mm	0,76 mm	6,7 m

Property	Test method	Typical values
Breaking Strength (tensile)	ASTM-D-4325	1.8 MPa min
Elongation at break	ASTM-D-4325	300 % min
Amalgamation ability	ASTM-D-4325	2,0 mm
Overload temperature	ASTM-D-4388	100°C
Operating temperature	ASTM-D-4388	90°C
Dielectric strength	ASTM-D-4325	20 kV/mm min



## Raytefill

Thick low voltage Self-amalgamating tape.

This self-amalgamating thick-wall (3.2mm) has been specially designed for the rapid reconstruction of low-voltage cable insulation, to cover complex shapes (insulating and covering joints between busbars and relative bolts, clamps, etc.) and to seal against possible penetration of humidity. Once applied it becomes a solid, absolutely non-porous mass, with first class electrical qualities and ageing resistance, perfectly suited to the product it is covering.

Product	Colour	Width	Thickness	Length
Raytefill	●	38 mm	3,2 mm	1,5 m

Property	Test method	Typical values
Ultimate elongation	ASTM-D-4325	>1000 %
Amalgamation ability	ASTM-D-4325	2,0 mm
Operating temperature: Continuous	ASTM-D-4388	90°C
Operating temperature: Overload	ASTM-D-4388	95°C
Dielectric strength	ASTM-D-4325	23,0 kV/mm



Approvals  
MIL-I-17695 A

## Raytech 7-0

Self-amalgamating silicone rubber tape.

This self-amalgamating silicone rubber tape is used for covering medium and high voltage terminations on extruded cables up to Um 72 kV, because of its first-rate performance for electrical installations in damp or polluted environments, against corrosion, corona and against ageing. It is used as an insulation up to 180°C due to its excellent heat properties. It can be perfectly adapted to all the shapes to be covered.

Product	Colour	Width	Thickness	Length
Raytech 7-0	●	25 mm	0,51 mm	9,1 m

Property	Test method	Typical values
Elongation at break	ASTM-D-1000	>500%
Resistance to U.V.	ASTM-D-4325	Positive
Resistance to ozone	ASTM-D-4325	Positive
Working temperature maximum	ASTM-D-4388	180°C
Dielectric strength	ASTM-D-4325	>35 kV/mm



Approvals  
ASTM-D-2148  
MIL-I-46852A

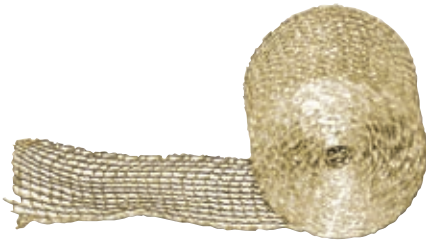

## Raycopper

Tinned copper mesh tape for electrical screening.

Product	Colour	Width	Thickness	Length
Raycopper 1000	Silver	60 mm	0,3 mm	1 m
Raycopper 2000	Silver	60 mm	0,3 mm	2 m
Raycopper 3000	Silver	60 mm	0,3 mm	3 m
Raycopper 5000	Silver	60 mm	0,3 mm	5 m
Raycopper 6000	Silver	60 mm	0,3 mm	6 m

Property	Typical values
Material	Tinned copper mesh tape with high flexibility
Elongation at break	70% min
Breaking Strength (tensile)	35 N/10 mm
Volume resistivity	0,3 cm

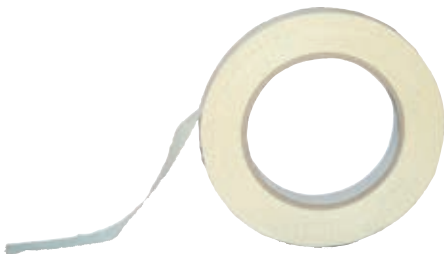
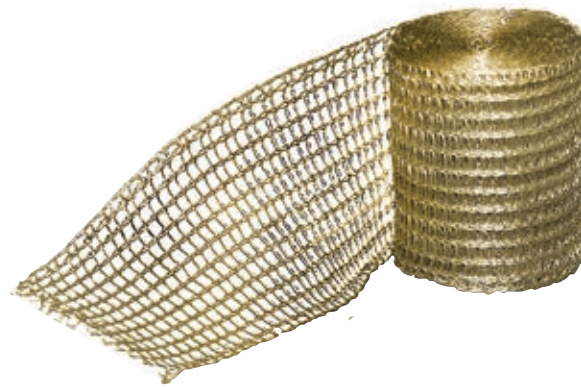

## MCA-FV

Fiberglass adhesive tape.

Self-adhesive mono-directional fibreglass tape with polypropylene support. Suitable for cable fixing on pipes (i.e.: Raytech MCA... cables for electrical tracing), and for any kind of strong fixing. Inextensible, it is suitable for temperatures up to 130°C.

Product	Colour	Width	Thickness	Length
MCA-FV	white	12 mm	0,13 mm	50 m

Property	Test method	Typical values
Breaking Strength (tensile)	AFERA 4004	130 N/cm min
Ultimate elongation	AFERA 4005	5%
Adhesion to steel	AFERA 4001	4 N/cm min
Adhesion to backing	AFERA 4001	3 N/cm min





## MCA-ALL

### Self-adhesive aluminium tape.

Self-adhesive adhesive aluminium tape suitable for fixing on flat surfaces (i.e.: for heating cable fixing on tanks outer surfaces); used also for holes or abrasion repairs on metallic or plastic surfaces. Strong adhesion.

Product	Colour	Width	Thickness	Length
MCA-ALL 75	Aluminium	75 mm	0,06 mm	50 m

Property	Typical values
Breaking Strength (tensile)	1,2 da N/cm min
Elongation at break	5% min
Adhesion to steel	4 N/cm min
Adhesion to backing	4,5 N/cm min
Flame resistance BS476-7	Class 1

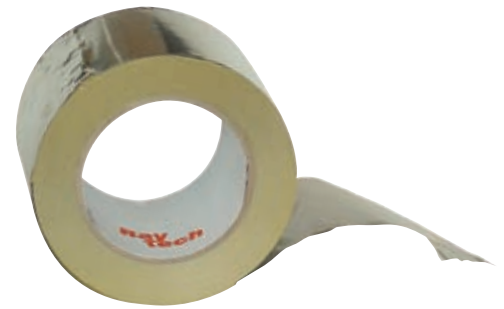

# CABLE PULLERS and LUBRICANTS

## Speedy Line

Raytech, leader in the field of cable accessories, has always based its research and product line on the quality. This is why, also in the field of the pulling tapes and lubricants, it is today offering systems of extremely high reliability and quality, always over the conventional types offered by the market:

- These fixed head, interchangeable nylon fishtapes are constructed with very high mechanical characteristic, long-lasting materials. Speedy Sonda tapes are made of PERLON, a practically non-deformable nylon, protecting the installer from unexpected elongation or breakage of the probe in ducts.
- "Twisted" polyester tapes, self-lubricated, extremely flexible and light, with exceptional mechanical characteristics, able to be inserted into long cable ducts, avoid the need of intermediate cable boxes; allowable bending radius is very small and, once bent, they do not break and released they come back to their original shape.
- Fibreglass tapes, thanks to their "nervous" elasticity together with their strength, are easy to use in any type of conduit.
- Nylon-steel tapes, when an exceptional strength is required.
- The widest range of accessories for all the types.
- Raytech offers the widest range of high sliding, non-toxic lubricants that are easily removable from cables. Choose from lubricant oil, lubricant gel (non-drip, allowing for a savings of up to 3 times compared to conventional types) or lubricant spray (easy application directly into the cable ducts, non-drip and dramatically reducing friction and traction force).



### Characteristics



Product	Positioning	Ease of bending	Pulling resistance
Speedy Nylon and Speedy Sonda	Good	Good	Very good
Polyester Speedy Helix	Very good	Very good	Very good
Fibreglass Speedy Glass	Excellent	Good	Good
Nylon-Steel Speedy Steel	Very good	Excellent	Excellent

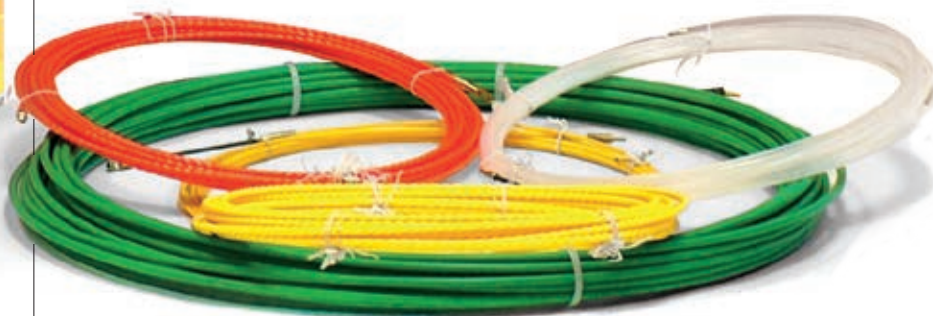

**Speedy Nylon**  
Fixed head Nylon probes

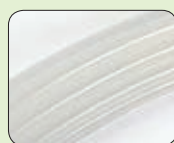

**Speedy Sonda 3**  
Fixed head or interchangeable Nylon Perlon® Ø 3 mm



**Speedy Sonda 4**  
Fixed head or interchangeable Nylon Perlon® Ø 4 mm

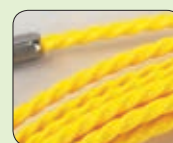

**Speedy Helix 5**  
Polyester Ø 5 mm with eyelet and fixed flexible head



# Speedy Wire Oil - Speedy Wire Gel - Speedy Wire Spray

Lubricants for threading any kind of cable, power, telecom and optical fibre in ducts, smooth or corrugated piping, etc. With a very high lubrication power, especially when compared to products for similar uses, these are easily removable from cables, and require very low installation strength, even in the case of bent conduits.

**Speedy Wire Oil** is a standard, fluid and low viscosity lubricant.

**Speedy Wire Gel**, thanks to its consistency, allows for savings of up to 3 times the amount used compared to other solutions.

**Speedy Wire Spray**, thanks to its canister and dispensing nozzle, allows for suitable guiding of the lubricant, including inside piping and ducts, greatly facilitating application.



Product	Package	Wrapping	Appearance	PH	Density
Speedy Wire Oil	1 L bottle	12-piece pack	Transparent gel	6 - 8	About 1
Speedy Wire Gel	1 L bottle	12-piece pack	Milky liquid	6 - 8	About 1
Speedy Wire Spray	400 ml canister	12-piece pack	White foam	8,5 - 9	About 1,04

# Speedy Nylon

Fixed head Nylon transparent cable pullers.

Product	Ø (mm)	Length (m)	Package
Speedy Nylon 3/5-F	3	5	50
Speedy Nylon 3/10-F	3	10	40
Speedy Nylon 3/15-F	3	15	30
Speedy Nylon 3/20-F	3	20	20
Speedy Nylon 3/25-F	3	25	15
Speedy Nylon 4/5-F	4	5	50
Speedy Nylon 4/10-F	4	10	25
Speedy Nylon 4/15-F	4	15	20
Speedy Nylon 4/20-F	4	20	15
Speedy Nylon 4/25-F	4	25	12

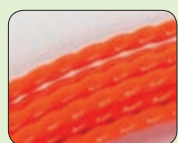
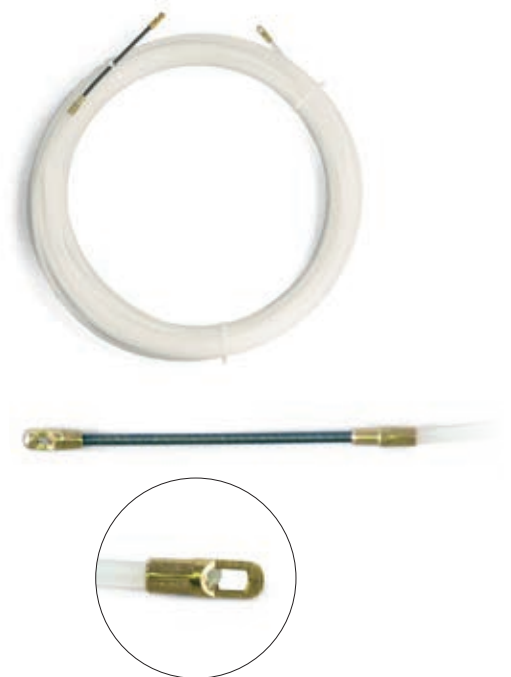

**Speedy Helix 4**  
Polyester Ø 4 mm with eyelet and fixed flexible head

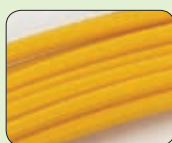

**Speedy Glass**  
Interchangeable head fibreglass probe Ø 3 mm

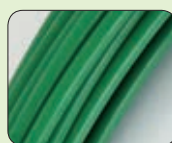

**Speedy Steel**  
Nylon-steel probe Ø 6 mm



**Accessories**



## Speedy Sonda 3

Nylon tape PERLON® Ø 3 mm with fixed or interchangeable head\*.

### Fixed head

Product	Colour	Ø (mm)	Length (m)	Item packaging
Speedy Sonda 3/5 -F	Transparent	3	5	50
Speedy Sonda 3/10 -F		3	10	40
Speedy Sonda 3/15 -F		3	15	30
Speedy Sonda 3/20 -F		3	20	20

### Interc. head

Speedy Sonda 3/5 -I	Transparent	3	5	50
Speedy Sonda 3/10 -I		3	10	40
Speedy Sonda 3/15 -I		3	15	30
Speedy Sonda 3/20 -I		3	20	20

Other dimensions available on request

\* Supplied with flexible head curve guide and pulling eyelet



## Speedy Sonda 4

Nylon tape PERLON® Ø 4 mm with fixed or interchangeable head\*.

### Fixed head

Product	Colour	Ø (mm)	Length (m)	Item packaging
Speedy Sonda 4/5 -F	Transparent	4	5	35
Speedy Sonda 4/10 -F		4	10	25
Speedy Sonda 4/15 -F		4	15	20
Speedy Sonda 4/20 -F	Black **	4	20	18
Speedy Sonda 4/25 -F		4	25	15

### Interc. head

Speedy Sonda 4/5 -I	Transparent	4	5	35
Speedy Sonda 4/10 -I		4	10	25
Speedy Sonda 4/15 -I		4	15	20
Speedy Sonda 4/20 -I	Black **	4	20	18
Speedy Sonda 4/25 -I		4	25	15

Other dimensions available on request

\* Supplied with flexible head curve guide and pulling eyelet

\*\* For the colour black **add N** to the code





## Speedy Helix 5

Polyester tape Ø 5 mm with fixed eyelet and flexible interchangeable head.

Twisted tapes, very strong, extremely flexible and light. They pass the "4 curves test" on both rigid and corrugated pipes, but they can also avoid to have an intermediate box, and even if bent on themselves they do not break.

Product	Colour	Ø (mm)	Length (m)	Item packaging
Speedy Helix 5/10	 Yellow	5	10	1
Speedy Helix 5/15		5	15	1
Speedy Helix 5/20		5	20	1
Speedy Helix 5/25		5	25	1
Speedy Helix 5/30		5	30	1
Speedy Helix 5/50		5	50	1
Speedy Helix 5/60		5	60	1

Other dimensions available on request

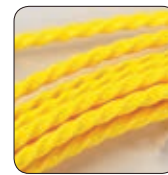

## Speedy Helix 4

Polyester tape Ø 4 mm with interchangeable eyelet and head\*.

Twisted tapes, very strong, extremely flexible and light. They pass the "4 curves test" on both rigid and corrugated pipes, but they can also avoid to have an intermediate box, and even if bent on themselves they do not break.

Product	Colour	Ø (mm)	Length (m)	Item packaging
Speedy Helix 4/10	 Orange	4	10	1
Speedy Helix 4/15		4	15	1
Speedy Helix 4/20		4	20	1
Speedy Helix 4/30		4	30	1

Other dimensions available on request

\* Supplied with flexible head curve guide and pulling eyelet





The tape is complete of repairing kit

## Speedy Glass

Interchangeable head “self-starting”  
fibreglass Ø 3 mm cable pullers\*.

Suitable for light use, even on long lengths, easy to use thanks to their “nervous” elasticity which makes easier their positioning in pipes and conduits.

Interc. head				
Product	Colour	Ø (mm)	Length (m)	Item packaging
Speedy Glass 3/10	 Yellow	3	10	10
Speedy Glass 3/15		3	15	10
Speedy Glass 3/20		3	20	10
Speedy Glass 3/25		3	25	10
Speedy Glass 3/30		3	30	10

Other dimensions available on request

\* Supplied with flexible head curve guide and pulling eyelet



## Speedy Steel

Nylon-steel tape Ø 6 mm complete of all accessories.









Nylon-steel tapes are extremely robust, and are made of an internal core 4 x 1,5 mm steel made, coated with a nylon layer. Particularly suitable for industrial use with heavy duty. Use in installations without voltage.

Product	Colour	Ø (mm)	Length (m)	Item packaging
Speedy Steel 6/20	 Green	6	20	1
Speedy Steel 6/25		6	25	1
Speedy Steel 6/30		6	30	1
Speedy Steel 6/40		6	40	1
Speedy Steel 6/50		6	50	1
Speedy Steel 6/60		6	60	1









Other dimensions available on request

## Accessories





For Speedy Sonda and Speedy Helix cable pullers.

Product	Description	Item packaging	
Speedy TFG	Flexible head curve guide	3	
Speedy TFC	Flexible head with sheave	3	
Speedy OTL	Long pulling eyelet	3	
Speedy OTC	Short pulling eyelet	3	
Speedy BU	Joint bush for fishtapes	3	
Speedy PN	Pin M4 (for tape Ø 4 mm)	3	
Speedy AT	Pulling slot	3	
Speedy CA	Accessories kit	1	

For Speedy Glass cable pullers.

Product	Description	Item packaging	
Speedy REP	Repairing kit	3	
Speedy TFG	Flexible head curve guide	3	
Speedy TFC	Flexible head with sheave	3	
Speedy OTL	Long pulling eyelet	3	
Speedy OTC	Short pulling eyelet	3	
Speedy BU	Joint bush for fishtapes	3	
Speedy PNG	Pin for Speedy Glass tape	3	
Speedy AT	Pulling slot	3	
Speedy CA	Accessories kit	1	

For Speedy Steel cable pullers.

Product	Description	Item packaging	
Speedy MO	Snap link	3	
Speedy TS	Flexible head curve guide	3	
Speedy OL	Clamping device	3	
Speedy RS	Sliding wheel device	3	

Available upon request.

Product	Description	Item packaging	Image
Speedy AS	Reels with support	1	(see A)
Speedy AF	Reels on frame	1	(see B)
Speedy AFS	Steel reels on frame	1	(see C)
Speedy PR Glass	Repairing pliers for Speedy Glass tapes	1	(see D)



(A)



(B)



(C)



(D)



# FIRE STOP BARRIERS



**Fire Stop Bag**  
Fire stop barrier using  
intumescent bags



**Fire Stop Panel**  
Fire stop barrier panels



**Fire Stop Collar**  
Fire stop pipe transit  
collar for plastic pipes



**FSC-TPC**  
Fire stop barrier for  
plastic and/or  
corrugated pipes  
with cables



**FSM**  
Fire stop barriers  
using incombustible  
plaster



**FSCP**  
Fire stop cover for  
fluorescent fittings



**FSCF**  
Fire stop cover  
for spot lights





### Fire Stop Tape

Fire stop barrier in an intumescent tape for plastic corrugated pipes



### Fire Stop Seal

Fire stop barrier with intumescent sealing mastic



### Fire Stop Foam

Fire stop barrier expanding foam



### FSCI

Fire stop barrier for switchgear covering

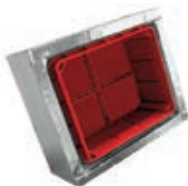

### FSCC

Fire stop cover for boxes



### FSSE

Intumescent fire stop barrier for electrical boxes



### FSCOT110

Metal pipe insulating mat protective barrier



### Approval

**Class** EI 120

Non toxic and asbestos free

In compliance with standard  
EN 1366-3

## Fire Stop Bag

Fire stop barrier in an intumescent bag.

Intumescent incombustible bags which stop the passage of fire through openings in walls. They are available in different sizes and they have to be placed to seal the openings, both in walls and floor slabs. At a temperature of 200°C the material starts to compact sealing the gaps thus avoiding the passage of the flames.

- Made from a fireproof fabric
- Contains intumescent putty seal inside

Product	Bag dimensions (mm)
FSB-11	250 x 100 x 25
FSB-12	250 x 200 x 35
FSB-13	250 x 300 x 35

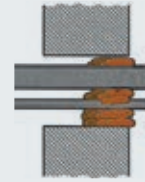

### INSTALLATION

Finish and opening then lay the bags as bricks, staggered and overlapped.

For the application on plasterboard walls please contact Raytech.



### Approval

**Class** EI 120

Non toxic, asbestos and solvent free

In compliance with standard  
EN 1366-3

## Fire Stop Panel

Fire stop barriers in panels.

Incombustible panels treated on the surface with putty to stop the passage of fire through openings in walls. This product allows for the sealing of cavities in walls safely and cost effectively.

- Manufactured from Rockwool
- Coated with putty
- Resistant to mould and bacteria

Product	Dimension (mm)
FSP-11	600 x 600 x 51



### INSTALLATION

Finish and clean the opening edges then cut the panels with a cutters and position them in the opening. The edges and the jointing lines, as well as the interstices among the cables, are sealed and covered with FIRE STOP SEAL FSS sealant..

For the application on plasterboard walls please contact Raytech.



## Fire Stop Collar

Fire stop transit collar for plastic pipes.

Fire stop barrier transit collar for plastic pipes (minimum wall thickness 200mm). Available in a wide range of dimensions to surround pipes that pass through walls.

- Stainless steel outer band
- Contains intumescent putty seal inside

Product	∅ (mm)
FSC 11	from 63 to 110
FSC 12	from 110 to 160
FSC 13	200
FSC 14	250

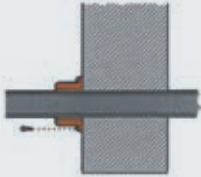

**INSTALLATION**  
No special care is required: the collar, when opened, is positioned around the duct, closed and fastened by means of inserts

For other dimensions and installation please contact Raytech.



### Approval

**Class** EI 120  
Non toxic and asbestos free

In compliance with standard EN 1366-3

## Fire Stop Tape

Fire stop barrier in an intumescent tape for plastic corrugated pipes.

Fire stop barrier in an intumescent tape for the crossing closure of single corrugated pipes. Highly heat-sensitive, intumescent graphite tape with high expansion properties for the protection of corrugated electrical pipes containing cables. Applied on both sides of the pipe crossing through the wall so as to surround the pipe. The heat from a fire causes the tape to expand and fill all possible voids.

Product	Application corrugated pipe diameter range (mm)	Width (mm)	Thickness (mm)	Length (m)
FST-E-25/32	from 25 to 32 *	20	2	10

\*containing cables up to 10 mm<sup>2</sup>

### RECOMMENDATION

The solution is 10m long, and it can be cut at the required length, saving the remaining parts for a future application. Can also be used in conjunction with FSCI, FSSE, FSCC box covering protections.

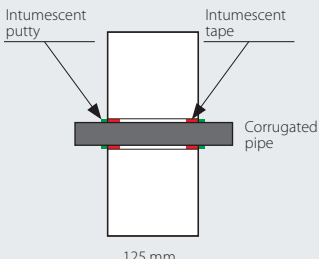

**INSTALLATION**  
Wrap the tape twice around the corrugation, on both sides of the wall, fitting it in the through hole. Seal with FIRE STOP SEAL (FSS) sealant putty. Let dry.



### Approval

**Class** EI 120  
Non toxic and asbestos free

In compliance with standard EN 1366-3



### Approval

**Class** EI 120  
Non toxic and asbestos free  
Does not emit toxic gases  
and dense fumes

In compliance with standard  
EN 1366-3

## Fire Stop Seal

Fire stop barrier in intumescent sealing mastic.

Intumescent mastic to seal and close small voids in walls, also in addition to other types of barriers. It is applied to seal a void or to provide a barrier in a cable duct.

- A polymer compound with fireproof fibres and intumescent in an aqueous solution
- Non-hygroscopic and thixotropic
- Can be applied with a spatula

Product	Package
FSS 310	0,3 kg cartridge
FSS 10	Spatula type, 10 kg drum

**INSTALLATION**  
Once the edges of the opening have been finished and cleaned, the sealant putty is put in place with a spatula in the case of boxed product, or with a spatula or silicone gun for cartridge product.

For other dimensions or the application on plasterboard walls please contact Raytech.

## Intumescent sealant putty for corrugated pipes.

Putty containing highly heat-sensitive graphite, specifically for corrugated electrical pipes containing cables. Crossing can contain up to two 25mm corrugated pipes paired in the same hole with cable with cross-section up to 10mm<sup>2</sup>.

Product	Package
FSS-E-300	0,3 lt cartridge

**INSTALLATION**  
The putty must be applied on both sides of the piping crossing through the wall.



### Approval

**Class** EI 120  
Non toxic and asbestos free  
Does not emit toxic gases  
and dense fumes

In compliance with standard  
EN 1366-3

## Fire Stop Foam

Fire stop barriers in expanding foam.

Single-component expandable sealant foam for filling and fire sealing of small crossing gates on cable duct channels that have been previously compartmented with FSB bags and small gaps. Each canister covers a volume of approximately 20 L.

- Made from a fire resistant polyurethane based foam
- Graphite fortified
- Hardens upon contact with air
- Suitable for the protection of plasterboard walls or slabs

Product	Package
FSF 700	Spray can of 750 ml

**INSTALLATION**  
After the edges of the openings have been cleaned, shake the can for at least 30 seconds, then turn upside down and spray the product.







## FSC-TPC

Fire stop barrier for plastic and/or corrugated pipes with cables.

Protection designed to be built into the wall after pipes have been installed. Can be installed in locations where the construction support is damaged and there is an annular space around the services. It is possible to protect mixed corrugated plastic pipes in the same crossing.

- For PE/PP, PVC, Abs pipes containing electrical cables or other services
- Pipes can be grouped and protected in bundles

Product	For pipes with diameter up to mm
FSC-TPC 050	50
FSC-TPC 060	60
FSC-TPC 090	90
FSC-TPC 120	125

### INSTALLATION

Clean the pipe. Open the sleeve longitudinally, place it around the pipe and clamp it on it using special metal tabs. Push the collar towards the centre of the wall.

Fix with FSS putty in the event of installation on a special crossover pipe.

Contact Raytech regarding through openings or installation on inclined piping.



### Approval

#### Class EI 120

Non toxic and asbestos free  
Does not emit toxic gases and dense fumes

In compliance with standard EN 1366-3

## FSM

Fire stop barriers in incombustible plaster.

Protective coating to seal and prevent fire propagation in wall cavities; it can be applied manually or sprayed. It can be easily mixed in big quantities with suitable mixer (e.g. concrete mixer).

- Made from mineral fibres
- Simply mix with water and with or without cement mixes
- For gates on walls or slabs

Product	Package
FSM 20	20 kg bag

### INSTALLATION

After the edges of the openings have been finished and cleaned, the incombustible plaster is mixed with water, then applied manually, with a trowel or a pump, and left to dry in air. Water quantity: about 0,85 lt/kg (volume 1 kg = about 2,5 dm<sup>3</sup>).

For other applications please contact Raytech.



### Approval

#### Class EI 120

Non toxic and asbestos free  
Does not emit toxic gases and dense fumes

In compliance with standard EN 1366-3

## FSCP

Fire stop barriers for ceiling lights.

Fireproof barriers for fluorescent lights in suspended ceilings. Maintains conditions of fire resistance of ceilings and suspended ceilings. Slightly reduces the temperature in the space between the ceiling and the ceiling panel.

- Made from non-toxic mineral fibres
- Prevents propagation
- Flexible, light and self-supporting, easy to install and to remove

Product	Dimension (mm)	Weight (kg)
FSCP 600	720 x 750 x 150	1,7 about
FSCP 1200	1330 x 720 x 140	3,5 about



### INSTALLATION

No special care is required. The protection must be placed on the ceiling light grid adhering to the panel.



### Approval

#### Class EI 120

Non toxic and in compliance with standard EN 1365-2 • 1363-1



### Approval

**Class EI 120**  
Non toxic

It expands up to 5 times

In compliance with standard  
EN 1365-2 • 1363-1

## FSCF

### Fire stop hoods for downlighters.

Fireproof dome shaped hood for downlighters in suspended ceilings. Maintains conditions of fire resistance of ceilings and suspended ceilings. Prevents fire propagation and slightly reduces the temperature in the void between the ceiling and the suspended ceiling.

- Made from non-toxic mineral fibres
- Resistant to fire and expandable compounds
- Prevents lamp overheating
- Flexible, light and self-supporting
- Easy to install and to remove

Product	Dimension (mm)	Type
FSCF 250	250 x 280	Cone-shaped
FSCF 350	350 x 230	Dome-shaped

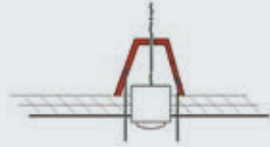

**INSTALLATION**  
No special care is required. The protection must be placed on the spotlight, adhering to the panel.

For other dimensions please contact Raytech.



### Approval

**Class EI 120**  
Non toxic

In compliance with standard  
EN 1364-1

## FSCI

### Fire stop barrier to cover switchgear.

Intumescent, fireproof barrier to cover switches and to maintain the fire resistance of walls. Compatible with standard enclosures. Reduces the temperature of cavities within plaster-board walls.

- Made with fireproof fibres and intumescent materials
- Protects from fire propagation

Product	Dimension (mm)
FSCI 150	150 x 150

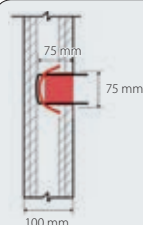

**INSTALLATION**  
No special care is required. The protection must be placed on the box, adhering to the wall.



### Approval

**Class EI 120**  
Non toxic

In compliance with standard  
EN 1364-1

## FSSE

### Intumescent fire stop barrier for electrical boxes.

Intumescent barrier for the fire protection of electrical system components built into walls.

- Inserted in electrical boxes
- Protection with high expansion properties
- Guarantees wall conditions in the event of a fire

Product	For electric boxes
FSSE 01	Up to three modules (type 503)
FSSE 02	Up to six modules (type 506)

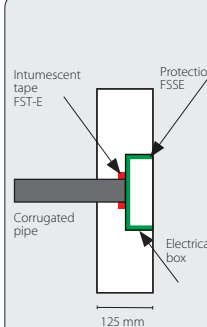

**INSTALLATION**  
The protections are inserted inside the box before the insertion of modules. Protect corrugated pipes crossing walls with FST-E-25/32



## FSCC

Fire stop barriers for covering enclosures.

Fire protection system for electrical enclosures and junction boxes. These protect plaster-board wall compartments from heat and fire propagation.

- Made from calcium silicate
- Contains enclosure

Product	External dimension (mm)	Internal dimension (mm)
FSCC 150	150 x 120 x 75	110 x 80 x 55

### INSTALLATION

After the opening edges have been finished and cleaned, the protection is properly placed and fixed to the wall by means of screws and putty.

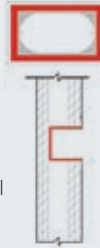

### Approval

#### Class EI 120

Non toxic and asbestos free  
Does not emit toxic gases and dense fumes

In compliance with standard EN 1364-1

## FSCOT110

Metal pipe insulating mat protective barrier.

The FSCOT110 barrier is made up a flexible and easily conformable, highly fire resistant insulating mat. It is clad with an aluminium sheet and protects insulated or non-insulated metal piping in wall crossings. The product is cut and modelled with ease, wrapped in a single layer around the pipe, and then closed with aluminised tape. Protects metal piping crossing walls or slabs, preventing longitudinal transmission of heat and fusion of any insulating material.

- Composed of fibres free of any resins or organic binders
- For wall thicknesses of at least 125 mm

Product	Colour	Width	Thickness	Length
FSCOT110	Aluminium	1 m	20 mm	5 m

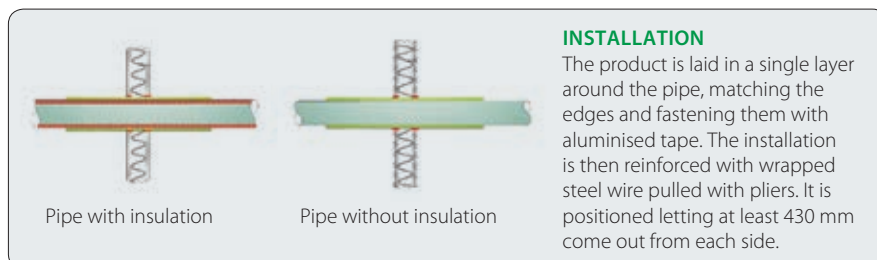

### INSTALLATION

The product is laid in a single layer around the pipe, matching the edges and fastening them with aluminised tape. The installation is then reinforced with wrapped steel wire pulled with pliers. It is positioned letting at least 430 mm come out from each side.



### Approval

#### Class EI 120

Non toxic and asbestos free

In compliance with standard EN 1366-1 • EN 1366-3 • EN 1366-5



# SPECIALS

## Galactic Line

KITS FOR THE CONNECTION, MAINTENANCE AND PROTECTION OF ELECTRICAL SYSTEMS

page  
154



**Galactic Mammut Security**  
Straight joint pre-filled with gel



**Galactic Protection**  
Bicomponent rubber for printed circuit protection against animal intrusion



**Galactic Animal Barrier**  
Mouldable rubber paste to prevent animal intrusion



**Galactic Water Stop**  
Ready to use single component gel for generic use

## Rubber Line

page  
160



**Ray RTV**  
Fast cross linking bicomponent silicone rubber



**Gasket Kit**  
Kit for the packaging of rubber profiles





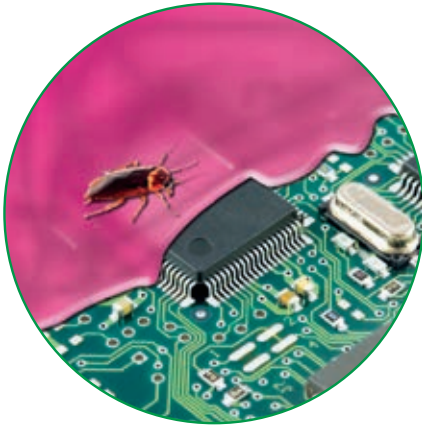

**Galactic Nano Joint**  
Straight and derived  
single pole joint  
complete with pre-filled gel  
snap connector



**Galactic Separator**  
Spacer and  
connector kit



**Galactic Cleaner Professional**  
Extraordinary detergent  
for all types of use

# Indispensable

page  
163



**Shiny Solar**  
Solution for solar and photovoltaic  
panel maintenance



Clamps

Clamp accessories





# Galactic Mammut Security

Straight joint pre-filled with gel.

Galactic Mammut Security is an extremely compact accessory that is suitable for resolving insulation and sealing problems. Make reliable strip connector connections using the components found within the kit. Supplied with connectors for up to 3 core 4mm cables. Suitable for all types of domestic and industrial uses. Make safe temporary or uninsulated connections already in place. For quick repairs of damaged cable and extension cords. Suitable for outdoor use, in panels, within the kitchen etc. Non-toxic, no shelf life, easily re-enterable. Once closed the internal connectors are immediately protected. Galactic Mammut is essential in any area where water is present.



- No more tangled wires or uncovered connectors!
- A safe, reliable and quick solution

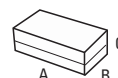

Product	Cable formation	Dimension A x B x C (mm)
Galactic Mammut Security	Cables 3 x 1 to 4 mm <sup>2</sup> 3 insulated conductors with ground from 1 to 4 mm <sup>2</sup>	61 x 35 x 28

**Package:**  
3-piece blister pack

**Electrical performance:**  
CEI EN 50393 as applicable  
(testing under water head  
of the accessory installed in a box)

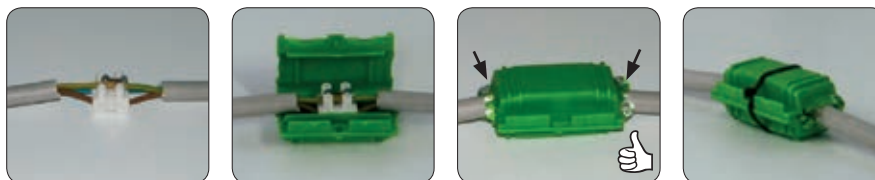

## BEFORE



## AFTER



# Galactic Protection

Bicomponent rubber for printed circuit protection including against animal intrusion.

Protection for printed circuits which are especially exposed to dust, animal intrusion (insects, snails, snakes, etc., e.g. in automatic gate trays). Opaque but slightly translucent allows cover forming a protective film. It can be removed (adheres without sticking) even on a small area to access the underlying component. The replaced component is then covered with new filler material which adheres perfectly to the previous material. Composed of bicomponent rubber with no shelf life and insulating and resistant to UV rays and ageing.

Product	Description	Rubber colour	Total quantity (ml)
Galactic Protection	bicomponent rubber	●	300

## Installation sequence

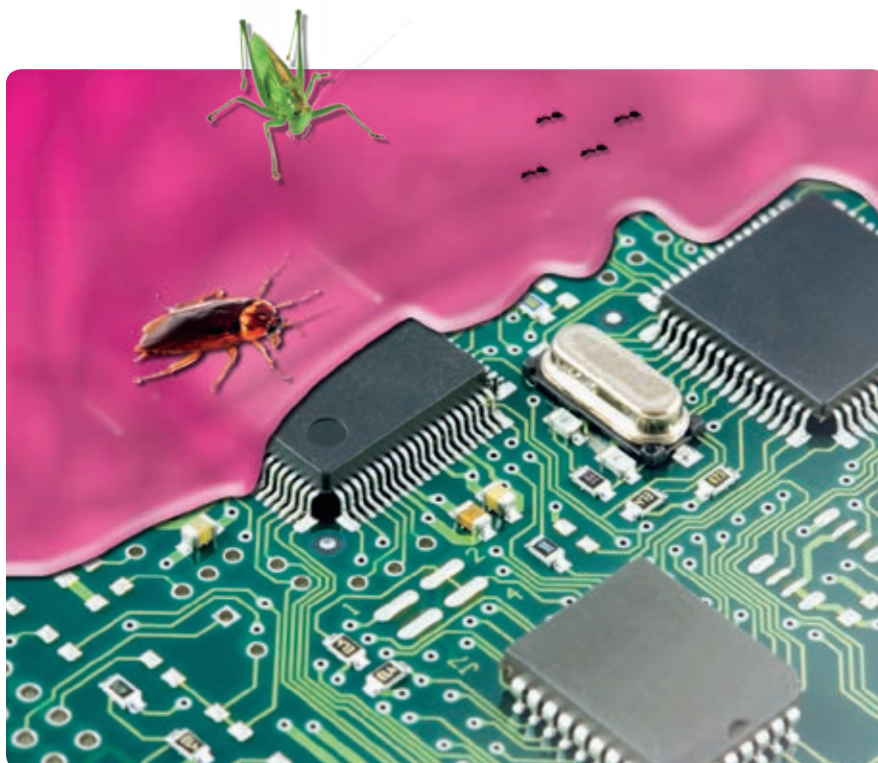

### Kit composition:

2 vials bicomponent product





# Galactic Animal Barrier

Mouldable bicomponent rubber paste to prevent animal intrusion.

Galactic Animal Barrier is a bicomponent paste with no shelf life that can be easily be moulded before cross linking is complete. It can be applied to entries to protect against intrusion (conduits, cable ducts and pipes etc). It cross links quickly to form an effective barrier against small insects however it is easily removable. Ideal for electric gate type installations.



**Kit composition:**  
2 cans (bicomponent)

Product	Description	Rubber colour	Total quantity (g)
Galactic Animal Barrier	bicomponent rubber	●	250

## Installation sequence

2 minutes max

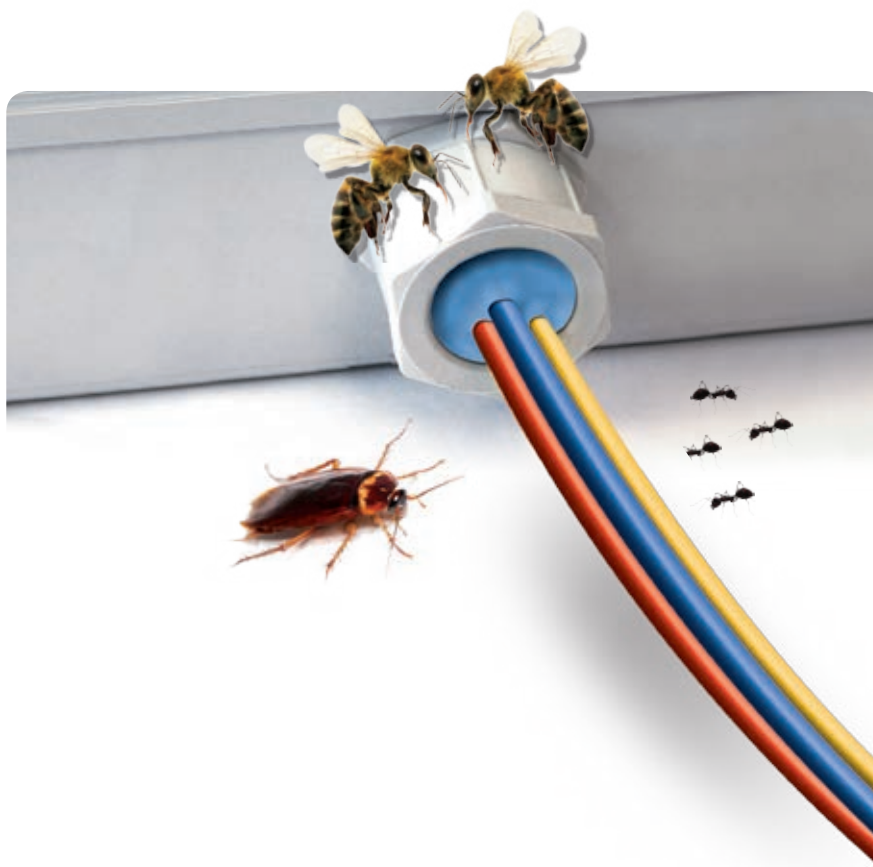



# Galactic Water Stop

Ready to use single component gel.

The Galactic Water Stop single component gel is a soft, extremely sticky product supplied in convenient, ready to use packages: just tear open the quantity needed and place it at the entry point to protect from infiltration. Thanks to its stickiness, it provides stable and effective sealing over time. Easily removable and re-enterable, allowing repeated access to the protected component without leaving traces. Non-drip so it can also be installed vertically or on the ceiling. Highly sealant, lends itself to the insulation of small connections, or for the protection of particularly exposed connections (connections to external car battery terminals, etc.). This product can be applied wherever there may be leakages from pipes, corrugated pipes, channels, etc., or where there is a need for rapid and efficient insulation.

Product	Description	Gel colour	Package (g)
Galactic Water Stop	single component gel	transparent	2 x 100

## Application example



Corrugated pipe entry protection



Removal



**Kit composition:**  
2 cans, 100 g each



**Kit composition:**  
3 complete Galactic NanoJoint

**Electrical performance:**  
CEI EN 50393 as applicable  
(testing under water head  
of the accessory installed in a box)

# Galactic Nano Joint

Pre-filled straight and branch single pole joint complete with lever arm connector.

Single core gel joint for straight and branch connection for insulated cables and conductors up to 4 mm<sup>2</sup>, complete with snap connector: simply strip the conductor and close the casing.

- Safe, quick, non-toxic, re-enterable
- For submersible use
- Connector with voltage detection window
- Connections without crimping or screws

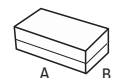

Product	Cable formation (n° x mm <sup>2</sup> )	Dimension A x B x C (mm)
Galactic Nano Joint 4	1 x 0,08 - 4	61 x 35 x 28

## Installation sequence

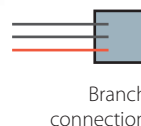
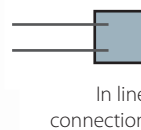

# Galactic Separator

Spacer and connector kit.

Kit includes 5 pole separators, 5 screw connectors and a roll of insulation tape. Once installed the connectors are separated by the wrap around casing. They can then be used in any enclosure which can be filled with Magic Gel, Ray Gel, Magic Rubber or Ray RTV.

Product	Maximum conductor cross section (n° x mm <sup>2</sup> )
Galactic Separator 6	5 x 1 a 6
Galactic Separator 16	5 x 2,5 a 16

Galactic Separator 6

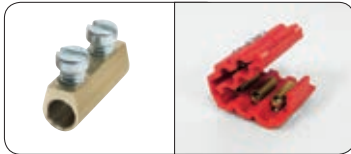

Galactic Separator 16

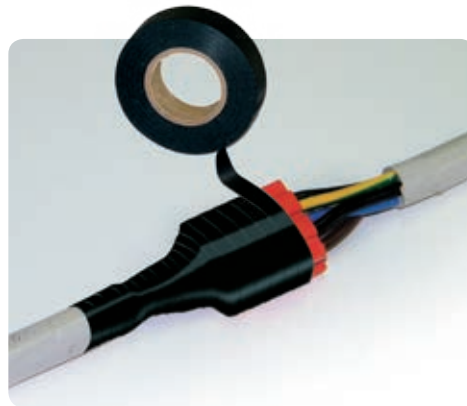
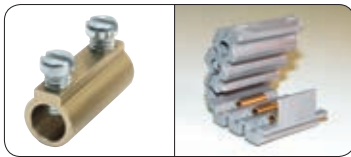

### Galactic Separator 6:

- 6 wrap-around separators (red) for connections up to 5 conductors
- 30 x 6 mm<sup>2</sup> screw connectors
- 1 Rayteam tape

### Galactic Separator 16:

- 3 wrap-around separators (grey) for connections up to 5 conductors
- 15 x 16 mm<sup>2</sup> screw connectors
- 1 Rayteam tape

# Galactic Cleaner

Extraordinary detergent for all types of use.

Extremely effective, able to remove grease, encrustations and smog without damaging the surfaces on which it is applied. Wipe glass with a dry cloth. Do not apply to painted sheet metal.

- For many applications, cleans, de-greases, protects
- With excellent results even in impossible conditions

Product	Description	Quantity (ml)
Galactic Cleaner	Spray bottle	750



### Mode of use:

spray the product, leave a few minutes, rinse or remove with a cloth.





# Ray RTV

Fast cross linking bicomponent silicone rubber with high mechanical, thermal and elastic characteristics.

Ray-RTV cross links quickly at room temperature, transforming into a rubber with high mechanical, thermal and elastic characteristics. Available in single dose bags, bottles, tanks and boxes, in standard 30 Shore A hardness for black and 15 Shore A for pink. Fast cross linking (less than 8 minutes at 30°C) and easily re-enterable

- Highly resistant, non-stick, insulating and sealing
- No shelf life

- Density:** about 1.24 gr/cm<sup>3</sup> (black)  
1.05 gr/cm<sup>3</sup> (pink)
- Cross linking:** (pot life) at + 30°C: <8 minutes
- Viscosity:** 4000-6000 max MPas
- Elongation at break:** 350 %
- Tensile strength:** 2,8 MPa
- Operating temperature:** -60°C / +200°C
- Overload temperature:** +250°C
- Thermal conductivity:** 0,2 W/m<sup>2</sup>K
- Dielectric strength:** >21 kV/mm
- Volume resistivity:** >1,5 x 10 exp 15 Ω cm







Installation sequence



Applications Examples



Product	Colour	Weight	Shore A hardness	Package type
Bag-RTV 200-N	●	200 g	30	Single dose bag 
Bag-RTV 350-N	●	350 g	30	
Bag-RTV 200-R	●	200 g	15	
Bag-RTV 350-R	●	350 g	15	
Ray-RTV 1000-N	●	1000 g	30	Cans 
Ray-RTV 1000-R	●	1000 g	15	
Ray-RTV 10K-N	●	10 kg	30	Boxes 
Ray-RTV 20K-N	●	20 kg	30	
Ray-RTV 400K-N	●	400 kg	30	
Ray-RTV 10K-R	●	10 kg	15	
Ray-RTV 20K-R	●	20 kg	15	
Ray-RTV 400K-R	●	400 kg	15	

Other colours, hardness and cross linking times (pot life) are available upon request for tanks of 400 Kg. Ray-RTV is available in bags up to 600 g.

**Kit composition**

- 1 mould for elastic washers, insulating gaskets and rubber profiles
- 2 bottles of two-component liquid rubber

**Advantages**

- Use directly on site, usable in all weather conditions, easy installation, easy separation from the moulds

Note: max thickness: 3 mm



Side A



Side B



# Gasket Kit

Kit to produce rubber gaskets and profiles.

Kit for the assembly of elastic washers, insulating gaskets and rubber profiles, UV resistant and anti-aging, with working temperature up to 200°C and 30 Shore A hardness, suitable for any electrical, plumbing, or sealing work. The articles produced are suitable for the sealing of outdoor lamps, for the sealing and insulation of screwed and bolted components, for any maintenance, replacement or shimming work. Easy to use, the liquid component is poured and the pieces are ready in minutes, at room temperature and with no exothermic reaction. Easily removed from the mould. Rapid cross-linking at room temperature (<15 min). Elevated dielectric, mechanical, elastic and thermal properties.

- Without shelf life and re-enterable
- Low emission of smoke and toxic and corrosive gases
- Flexible and elastic over time

Product	Description	Rubber colour	Package (g)
Gasket Kit	Mould + Bicomponent liquid rubber	●	360

**FLAT GASKETS**

Ø External (mm)	Ø Internal (mm)
30	22
25,5	17
24	18
22	16,5
21	15
18	12
14	8
11	6
10	7
8	4

**RODS**

Ø (mm)
30
25
20
15
10

**PROFILES**

L x L (mm)
130 x 6
130 x 5
130 x 4
130 x 3
130 x 2

**GASKETS FOR TAPS**

Ø External (mm)	Ø Internal (mm)
22	4,5
15,8	4,5
14	4,5

**ANTISLIP**

L x L (mm)
30 x 30
25 x 25
20 x 20
15 x 15
10 x 10

**CORRUGATED**

L x L Ø - hole (mm)
30 x 30 - Ø hole 4,5

**Installation sequence**

Pour the 2 components in a 1:1 ratio in a beaker and mix.

Pour the product into the desired mould (30 sec max).

Remove the object from the mould.

<15 minutes at +23°C

# Shiny Solar

Solution for solar and photovoltaic panel maintenance.

Shiny Solar is a product for photovoltaic and solar module maintenance, for easy removal of grease, limestone and crystallised deposits, dust, smog, excrement, etc. A photovoltaic panel can reduce generated power by up to 15% for non-polluted areas and 25% for highly polluted areas, Regular use of Solar Shiny keeps systems running efficiently. Extremely effective and easy to apply, with no shelf life. To maintain system efficiency, proceed with 2-3 applications/year for medium-polluted areas. The degreasing and anti-static protection contained in the product allows excellent results even with rinsing with hard water (even higher than 30°F). Rapid application: treatment of a 6 kW system (approximately 50 m<sup>2</sup>), thanks to the fact that degreasing, cleaning and application of the anti-static protection are all part of one single operation, requires less than 20 minutes. Shiny Solar respects panel components, the aluminium frame, gaskets and protective glass. A single package of Shiny Solar can treat installed photovoltaic panel power from 10 to 15 kW, equal to a surface of about 80-120 m<sup>2</sup>. The order data table shows the power and surfaces which can be treated with different packages.

- For easy removal of grease, limestone and crystallised deposits, dust, smog, excrement, etc.
- Contains anti-static protection

Product	Product contents	Efficiency (kW/ surfaces treated per package)	
		Power in kW	Surfaces (m <sup>2</sup> )
Shiny Solar	750 ml	10 - 15	80 - 120
Shiny Solar 5	5 lt	70 - 100	530 - 800
Shiny Solar 1000	1000 lt	14.000 - 20.000	106.000 - 160.000
Shiny Brush SB4	brush microfiber		

## Application example



Spray the product evenly on the solar or photovoltaic panel or on the surface to be cleaned and protected.

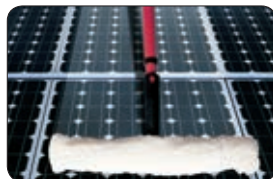

Let stand for a few minutes, depending on the level of dirt to be cleaned, then wipe with a soft, non-abrasive, slightly damp pad or sponge.



Rinse with water or remove product with a paper towel. Repeat for especially dirty surfaces.



## Advantages

The 750 ml and 5 lt kits are supplied together with a professional sprayer, with an adjustable spray jet nozzle with a range in the latter case of up to 3 m.

For proper application of the product even in hard to reach areas, a microfiber brush mounted on a telescopic arm which projects up to 4 m is available.



Shiny Brush SB4



Self extinguishing  
according to UL94

Halogen free  
Excellent resistance to basis, oils, fats,  
hydrocarbons, chemicals, chlorinated  
solvents

Operating temperature:   
-40°C / +85°C

Installation temperature:   
-10°C / +60°C

## Cable ties

Tilted tip for easy insertion into clamping head. Rounded corners for greater safety. Quick sliding thanks to a low material friction coefficient. Good UV resistance thanks to its black colour.

Essential for:

- Electrical installations
- Industrial applications
- Panels
- Special applications

Colour <b>White</b>	Colour <b>Black</b>	Width (mm)	Length (mm)	Appl. diameter		Strength	
<b>Product</b>	<b>Product</b>			min	max	(Kg)	(n)
Ray-fasc B 22/75	Ray-fasc N 22/75	2,2	75	0.75	15	6.12	60
Ray-fasc B 25/98	Ray-fasc N 25/98	2,5	98	1	21	8.16	80
Ray-fasc B 25/135	Ray-fasc N 25/135	2,5	135	1	32	8.16	80
Ray-fasc B 26/160	Ray-fasc N 26/160	2,6	160	1	40	8.16	80
Ray-fasc B 26/200	Ray-fasc N 26/200	2,6	200	2	52	8.16	80
Ray-fasc B 36/140	Ray-fasc N 36/140	3,6	140	2	35	13.26	130
Ray-fasc B 36/200	Ray-fasc N 36/200	3,6	200	2	50	13.26	130
Ray-fasc B 36/290	Ray-fasc N 36/290	3,6	290	2	80	13.26	130
Ray-fasc B 36/370	Ray-fasc N 36/370	3,6	370	2	103	13.26	130
Ray-fasc B 48/178	Ray-fasc N 48/178	4,8	178	2	45	22.44	220
Ray-fasc B 48/200	Ray-fasc N 48/200	4,8	200	3	50	22.44	220
Ray-fasc B 48/250	Ray-fasc N 48/250	4,8	250	3	68	22.44	220
Ray-fasc B 48/290	Ray-fasc N 48/290	4,8	290	3.5	79	22.44	220
Ray-fasc B 48/360	Ray-fasc N 48/360	4,8	360	3.5	103	22.44	220
Ray-fasc B 48/390	Ray-fasc N 48/390	4,8	390	3.5	106	22.44	220
Ray-fasc B 48/430	Ray-fasc N 48/430	4,8	430	3.5	115	22.44	220
Ray-fasc B 78/180	Ray-fasc N 78/180	7,8	180	3.5	45	55.08	540
Ray-fasc B 78/240	Ray-fasc N 78/240	7,8	240	3.5	63	55.08	540
Ray-fasc B 78/300	Ray-fasc N 78/300	7,8	300	4	80	55.08	540
Ray-fasc B 78/365	Ray-fasc N 78/365	7,8	365	8	100	55.08	540
Ray-fasc B 78/450	Ray-fasc N 78/450	7,8	450	35	130	55.08	540
Ray-fasc B 78/540	Ray-fasc N 78/540	7,8	540	35	158	55.08	540
Ray-fasc B 78/750	Ray-fasc N 78/750	7,8	750	35	220	55.08	540

100-piece pack



## Cable tie support

Fastening with standard inserts for cable ties with widths up to 9 mm. UV resistant.

Product	Dimension (mm)			
	A	B	C	D
Ray-fasc S	9,4	5	23	17,6

100-piece pack

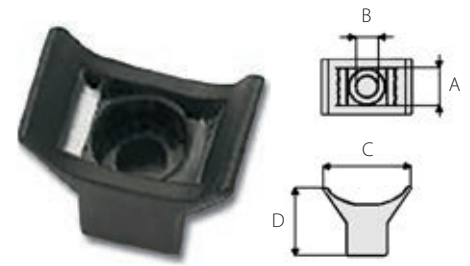

## Bi-Directional adhesive fixing device

Self adhesive, can be used on all materials. Suitable for cable ties up to 4.8 mm. Made from ABS with rubber based adhesive foam. UV resistant.

Colour <b>White</b>	Colour <b>Black</b>	Tie width (mm)	Dimension (mm)				
Product	Product		A	B	C	F	H
Ray-fasc BBA36	Ray-fasc NBA36	3,6	19	4,1	19	4	5
Ray-fasc BBA48	Ray-fasc NBA48	4,8	27	4,8	27	6	6,5

100-piece pack

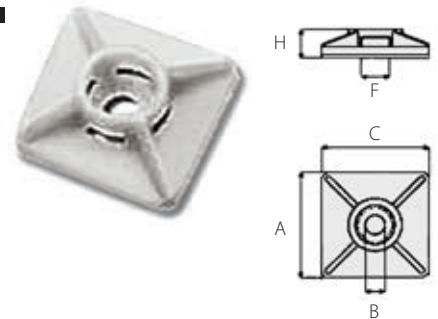

## Bayonet-Joint support

Push fit support for cable ties up to 7.8mm. Can be used on sheet surfaces with up to 3.2 mm thick. 6.2mm O/D hole required. Polyamide 6.6.

Product	Dimension (mm)						Ø Hole (mm)
	A	B	C	D	E	F	
Ray-fasc SI	10	10,6	8,1	3,2	8	7,1	6,2

100-piece pack

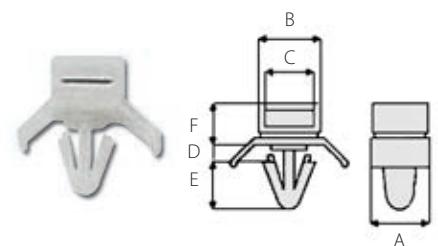





# Certified Medium Voltage Laboratory





A

### COLD-SHRINK



TERMINATIONS  
JOINTS

page 171

### HEAT-SHRINK

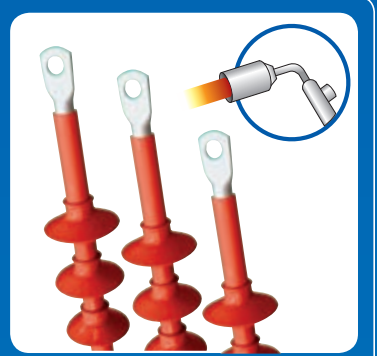

TERMINATIONS  
JOINTS

180



# Medium Voltage



HEAT-SHRINK 72 kV

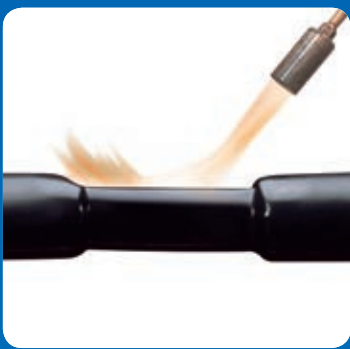

TERMINATIONS  
JOINTS

196



SEPARABLE  
CONNECTORS



PLUG  
SCREW

198



SHEATHS AND TAPES  
FOR INSULATION

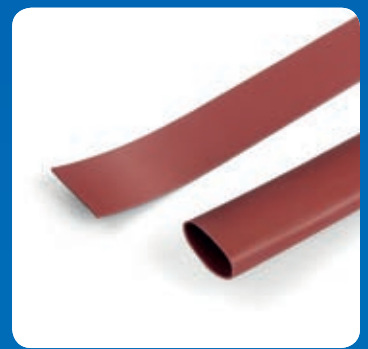

SHEATHS UP TO 36 kV  
TAPES UP TO 36 kV

200



# COLD-SHRINK

## Terminations

COLD-SHRINK FOR INDOOR AND OUTDOOR USE



Terminations for **indoor use**

For extruded cables  
up to 2/20 kV (Um 24 kV)



Terminations for **outdoor use**

For extruded cables  
up to 12/20 kV (Um 24 kV)



Terminations for **indoor/outdoor use**

For extruded cables  
up to 18/30 kV (Um 36 kV)

## Joints

COLD-SHRINK

**New**



Joints

For extruded cables up to 18/30 kV (Um 36 kV)



**Electrical performance:**  
CEI 20-24 • CEI 20-62/1 • HD 629-1

**Ranges of application:**  
For single core cables type



Extruded wire



Extruded tube AL

For voltages from 6/10 kV (U<sub>max</sub> 12 kV)  
to 12/20 kV (U<sub>max</sub> 24 kV)

## Cold-shrink terminations for **indoor use**

Silicone rubber terminations with electric field control.  
For extruded cables up to **12/20 kV (U<sub>m</sub> 24 kV)**.

Cold-shrink technology is based on pre-dilated insulating sheaths on a removable spiral support, which is removed without tools during installation to allow for complete covering of the cable insulation. The Raytech silicone sheath, supplied pre-expanded, is flame retardant, is highly anti-tracking, has very high elastic characteristics, is able to maintain pressure on the cable during operation, is water-repellent and is extremely sturdy. Raytech terminations are suitable for indoor, very compact applications, with a smooth structure and complete with all components. Each kit contains 3 single core indoor terminations. The components are cold-installed without tools, unwinding the pigtail wire.

- Rapid installation for lower labour costs
- Highly reliable and safe for operators
- Installing without heating and without tools

For cables (A)RG7H1R  
insulation thickness  
**FULL**

Product	Nominal voltage U <sub>max</sub> (kV)	∅ on insulation (mm)	∅ on external sheath (mm)	Conductor cross section (mm <sup>2</sup> )	Length without cable lug (mm)
AUTO 10 / 120-I	12	15,3 - 20,2	24,6 - 29,6	50 - 120	320
AUTO 10 / 240-I		18,7 - 25,6	28,0 - 35,8	95 - 240	320
AUTO 10 / 630-I		28,2 - 37,8	38,5 - 49,4	300 - 630	320
AUTO 15 / 70-I	17,5	16,3 - 19,2	25,6 - 28,7	35 - 70	320
AUTO 15 / 240-I		19,2 - 27,8	28,7 - 38,1	70 - 240	320
AUTO 15 / 630-I		27,8 - 40,0	38,1 - 52,1	240 - 630	320
AUTO 20 / 50-I	24	17,3 - 19,5	27,8 - 29,0	25 - 50	320
AUTO 20 / 185-I		19,5 - 27,4	29,0 - 37,8	50 - 185	320
AUTO 20 / 630-I		29,8 - 42,0	40,2 - 54,2	240 - 630	320

For cables RG7H1M1  
insulation thickness  
**LOW**

Product	Nominal voltage U <sub>max</sub> (kV)	∅ on insulation (mm)	∅ on external sheath (mm)	Conductor cross section (mm <sup>2</sup> )	Length without cable lug (mm)
AUTO 20 / 50-I	24	17,0 - 19,0	23,3 - 25,3	25 - 70	320
AUTO 20 / 185-I		21,0 - 28,0	26,7 - 34,5	95 - 240	320
AUTO 20 / 630-I		28,0 - 41,0	34,6 - 48,3	240 - 630	320

To select the correct termination:  
cable code, section in mm<sup>2</sup>, nominal voltage, for indoor and outdoor installation.



## Cold-shrink terminations for outdoor use

Silicone rubber outdoor terminations with electric field control and bell-shaped insulators. For extruded cables up to **12/20 kV (U<sub>m</sub> 24 kV)**.

The Raytech silicone sheath, supplied pre-expanded, is flame retardant, is highly anti-tracking, has very high elastic characteristics, is able to maintain pressure on the cable during operation, is water-repellent and is extremely sturdy. With pre-dilated silicone fins on a spiral support for modular installation of the outdoor accessory for upside-down installation. Raytech terminations are suitable for external, very compact applications, complete with all components. Each kit contains 3 single core outdoor terminations. The components are cold-installed without tools, unwinding the pigtail wire.

- Rapid installation for lower labour costs
- Highly reliable and safe for operators
- Installing without heating and without tools

Product	Nominal voltage U <sub>max</sub> (kV)	Ø on insulation (mm)	Ø on external sheath (mm)	Conductor cross section (mm <sup>2</sup> )	Length without cable lug (mm)
For cables (A)RG7H1R insulation thickness <b>FULL</b>					
AUTO 10 / 120-E	12	15,3 - 20,2	24,6 - 29,6	50 - 120	410
AUTO 10 / 240-E		18,7 - 25,6	28,0 - 35,8	95 - 240	410
AUTO 10 / 300-E		28,0 - 29,0	35,5 - 39,0	300	410
AUTO 10 / 630-E		28,3 - 37,8	38,5 - 49,4	300 - 630	420
AUTO 15 / 70-E	17,5	16,3 - 19,2	25,6 - 28,7	35 - 70	410
AUTO 15 / 240-E		19,2 - 27,8	28,7 - 38,1	70 - 240	410
AUTO 15 / 300-E		30,0 - 31,0	38,0 - 41,0	300	410
AUTO 15 / 630-E		30,4 - 40,0	40,2 - 52,1	300 - 630	420
AUTO 20 / 50-E	24	17,3 - 19,5	27,8 - 29,0	25 - 50	410
AUTO 20 / 185-E		19,5 - 27,4	29,0 - 37,8	50 - 185	410
AUTO 20 / 240-E		27,5 - 31,0	35,7 - 41,0	185 - 240	410
AUTO 20 / 630-E		29,8 - 42,0	40,2 - 54,2	240 - 630	420

Product	Nominal voltage U <sub>max</sub> (kV)	Ø on insulation (mm)	Ø on external sheath (mm)	Conductor cross section (mm <sup>2</sup> )	Length without cable lug (mm)
For cables RG7H1M1 insulation thickness <b>LOW</b>					
AUTO 20 / 50-E	24	17,0 - 19,0	23,3 - 25,3	25 - 70	410
AUTO 20 / 185-E		21,0 - 28,0	26,7 - 34,5	95 - 240	410
AUTO 20 / 240-E		28,0 - 31,5	34,6 - 42,0	240 - 300	410
AUTO 20 / 630-E		31,0 - 41,0	37,4 - 48,3	300 - 630	420

To select the correct termination: cable code, section in mm<sup>2</sup>, nominal voltage, for indoor and outdoor installation.



#### Electrical performance:

CEI 20-24 • CEI 20-62/1 • HD 629-1

#### Ranges of application:

For single core cables type

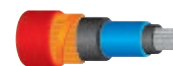

Extruded wire



Extruded tube AL

For voltages from 6/10 kV (U<sub>max</sub> 12 kV) to 12/20 kV (U<sub>max</sub> 24 kV)



**Electrical performance:**  
CEI 20-24 • CEI 20-62/1 • HD 629-1

**Ranges of application:**  
For single core cables type



Extruded tube AL



Extruded wire



#### INSTALLATION TIPS:

- Follow the dimensions stated in the installation instructions.
- Be careful not to cut through the insulation on the primary cable when removing the semi-conductive.
- The semiconductor cable must not have spikes or irregular profiles in the cutting zone.
- Carefully clean cable insulation.
- Install the correct cable terminal.

## Cold-shrink terminations for indoor/outdoor use

Silicone rubber terminations with electric field control. For extruded cables up to **18/30 kV (Um 36 kV)**.

The Raytech silicone sheath, supplied pre-expanded, is flame retardant, is highly anti-tracking, has very high elastic characteristics, is able to maintain pressure on the cable during operation, is water-repellent and is extremely sturdy. With pre-dilated silicone fins on a spiral support for modular installation of the accessory, for upside-down installation. Suitable for outdoor and indoor, very compact applications, complete with all components. Each kit contains 3 single core indoor terminations. The components are cold-installed without tools, unwinding the pigtail wire.

- Rapid installation for lower labour costs
- Highly reliable and safe for operators
- Installing without heating and without tools

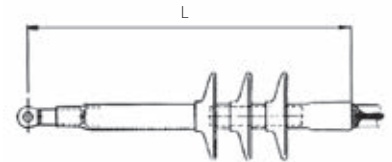

### FOR INDOOR USE

For cables (A)RG7H1R insulation thickness <b>FULL</b>					
Product	Nominal voltage U <sub>max</sub> (kV)	∅ on insulation (mm)	∅ on external sheath (mm)	Conductor cross section (mm <sup>2</sup> )	Dimensions L (mm)
AUTO 30/95-I	36	22,3 - 27,9	33,5 - 38,5	25 - 95	410
AUTO 30/120-I		29,4 - 31,0	37,3 - 41,2	120 - 150	410
AUTO 30/400-I		30,6 - 40,3	39,0 - 51,3	150 - 400	410

For cables RG7H1M1 insulation thickness <b>LOW</b>					
Product	Nominal voltage U <sub>max</sub> (kV)	∅ on insulation (mm)	∅ on external sheath (mm)	Conductor cross section (mm <sup>2</sup> )	Dimensions L (mm)
AUTO 30/95-I	36	25,0 - 27,0	31,2 - 33,4	50 - 120	410
AUTO 30/120-I		28,0 - 29,0	32,3 - 35,0	150 - 185	410
AUTO 30/400-I		28,0 - 40,0	34,6 - 47,9	150 - 500	420

### FOR OUTDOOR USE

For cables (A)RG7H1R insulation thickness <b>FULL</b>					
Product	Nominal voltage U <sub>max</sub> (kV)	∅ on insulation (mm)	∅ on external sheath (mm)	Conductor cross section (mm <sup>2</sup> )	Dimensions L (mm)
AUTO 30/95-E	36	22,3 - 27,9	33,5 - 38,5	25 - 95	680
AUTO 30/120-E		29,4 - 31,0	37,3 - 41,2	120 - 150	680
AUTO 30/400-E		30,6 - 40,3	39,0 - 51,3	150 - 400	680

For cables RG7H1M1 insulation thickness <b>LOW</b>					
Product	Nominal voltage U <sub>max</sub> (kV)	∅ on insulation (mm)	∅ on external sheath (mm)	Conductor cross section (mm <sup>2</sup> )	Dimensions L (mm)
AUTO 30/95-E	36	25,0 - 27,0	31,2 - 33,4	50 - 120	680
AUTO 30/120-E		28,0 - 29,0	32,3 - 35,0	150 - 185	680
AUTO 30/400-E		28,0 - 40,0	34,6 - 47,9	150 - 500	680

## Three-core cold-shrink terminations for indoor/outdoor use

Terminations for armoured and non armoured extruded cables up to **36 kV**.

Hybrid technology that provides heat-shrink trifurcation and cold-shrink termination

### FOR INDOOR USE

For <b>NON ARMoured</b> cables	For <b>ARMoured</b> cables	U <sub>max</sub> 12 kV sez. (mm <sup>2</sup> )	U <sub>max</sub> 17,5 kV sez. (mm <sup>2</sup> )	U <sub>max</sub> 24 kV sez. (mm <sup>2</sup> )
Product	Product			
AUTO 20/50-I-3	AUTO 20/50-I-3ARM	50 - 120	35 - 70	25 - 50
AUTO 20/185-I-3	AUTO 20/185-I-3ARM	95 - 240	70 - 240	50 - 185
AUTO 20/630-I-3	AUTO 20/630-I-3ARM	300 - 500	240 - 400	240 - 300

For <b>NON ARMoured</b> cables	For <b>ARMoured</b> cables	Voltage U <sub>max</sub> (kV)	Conductor cross section (mm <sup>2</sup> )
Product	Product		
AUTO 30/95-I-3	AUTO 30/95-I-3ARM	36	25 - 95
AUTO 30/240-I-3	AUTO 30/240-I-3ARM		120 - 240

### FOR OUTDOOR USE

For <b>NON ARMoured</b> cables	For <b>ARMoured</b> cables	U <sub>max</sub> 12 kV sez. (mm <sup>2</sup> )	U <sub>max</sub> 17,5 kV sez. (mm <sup>2</sup> )	U <sub>max</sub> 24 kV sez. (mm <sup>2</sup> )
Product	Product			
AUTO 20/50-E-3	AUTO 20/50-E-3ARM	50 - 120	35 - 70	25 - 50
AUTO 20/185-E-3	AUTO 20/185-E-3ARM	95 - 240	70 - 240	50 - 185
AUTO 20/630-E-3	AUTO 20/630-E-3ARM	300 - 500	240 - 400	240 - 300

For <b>NON ARMoured</b> cables	For <b>ARMoured</b> cables	Voltage U <sub>max</sub> (kV)	Conductor cross section (mm <sup>2</sup> )
Product	Product		
AUTO 30/95-E-3	AUTO 30/95-E-3ARM	36	25 - 95
AUTO 30/240-E-3	AUTO 30/240-E-3ARM		120 - 240

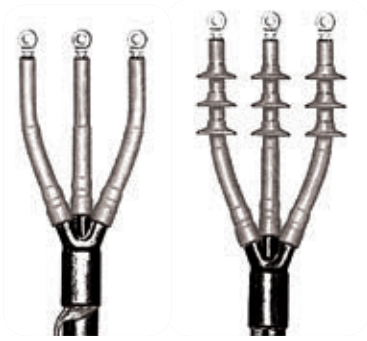

**Electrical performance:**  
CEI 20-24 • HD 629-1

Note: for three-core cables, insulation thickness low, please contact Raytech



Three-core extruded cable, wire screened

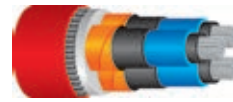

Three-core extruded cable, tape screened, armoured



**Electrical performance:**  
CEI 20-24 • CEI 20-62/1 • HD 629-1

**Ranges of application**  
For single core cables type



Extruded wire



Extruded tapes

For voltages from 6/10 kV (U<sub>max</sub> 12 kV)  
to 12/20 kV (U<sub>max</sub> 24 kV)

## Single core cold-shrink joints

Suitable for outdoor, underground and even underwater applications. Very compact and complete with all components. Each kit contains 1 single core joint. Each joint component is pre-dilated on a spiral support and is extremely easy to remove for fast, safe installation without the use of any tools or heating.

### Monoblock joints for extruded cables up to 12/20 kV (U<sub>m</sub> 24 kV).

Product	Nominal voltage U <sub>max</sub> (kV)	∅ on insulation (mm)	∅ on external sheath (mm)	Conductor cross section (mm <sup>2</sup> )	Length (mm)
For cables (A)RG7H1R insulation thickness <b>FULL</b>					
JMAUTO 20 / 95-1	12	17 - 23	26 - 33	70 - 150	550
JMAUTO 20 / 240-1		22 - 32	33 - 42	185 - 400	600
JMAUTO 20 / 400-1		32 - 36	42 - 48	400 - 630	600
JMAUTO 20 / 95-1	17,5	17 - 23	26 - 33	50 - 150	550
JMAUTO 20 / 240-1		22 - 32	33 - 42	150 - 300	600
JMAUTO 20 / 400-1		32 - 36	42 - 48	400 - 500	600
JMAUTO 20 / 95-1	24	17 - 23	26 - 33	25 - 95	550
JMAUTO 20 / 240-1		22 - 32	33 - 42	120 - 240	600
JMAUTO 20 / 400-1		32 - 36	42 - 48	300 - 400	600

Product	Nominal voltage U <sub>max</sub> (kV)	∅ on insulation (mm)	∅ on external sheath (mm)	Conductor cross section (mm <sup>2</sup> )	Length (mm)
For cables RG7H1M1 insulation thickness <b>LOW</b>					
JMAUTO 20 / 95-1	24	17 - 23	26 - 33	25 - 120	550
JMAUTO 20 / 240-1		22 - 32	33 - 42	120 - 300	600
JMAUTO 20 / 400-1		32 - 36	42 - 48	300 - 500	600

### Installation sequence



1 Cables are prepared and connected



4 The metal shield is rebuilt



2 Position at the centre of the connection



5 The outer protective sheath is positioned and installed

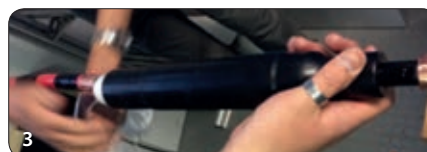

3 The spiral support is removed



6 The joint is ready and can be used immediately





# Single core cold-shrink singleblock joints 30 kv

Raytech joints for 30 kV (U<sub>max</sub> 36 kV) voltage are singleblock type. They are characterised by a pre-assembled body, composed of an elastomeric sleeve containing side deflector electrodes and the central electrode inside (Faraday cage), on which the metal shield for cable shielding continuity and the external protection sheath are already set.

**This allows for**

- Reduced overall size of the joint
- Smaller dig size
- Shorter installation times
- Easier installation
- Increased reliability
- Reduced possibility of error

The joints are suitable for all types of indoor, outdoor, underground and even submerged installation.

## Singleblock joints for extruded cables up to 18/30 kV (U<sub>m</sub> 36 kV).

Product	Nominal voltage U <sub>max</sub> (kV)	∅ on insulation (mm)	∅ on external sheath (mm)	Conductor cross section (mm <sup>2</sup> )	Length (mm)
JMAUTO 30 / 95-1	36	25 - 29	31,2 - 38,3	50 - 95	750
JMAUTO 30 / 185-1		27 - 31	33,4 - 42	120 - 185	750

JMAUTO 30/-1 joints are suitable for all extruded cable types.

### Installation sequence



1 The body of the joint carries the integrated shield and outer sheath



3 Position at the centre of the connection and collapsed on the cable removing the inner support



2 The joint is fitted on the connected cable



4 The joint is completed and can be used immediately



**Electrical performance:**  
CEI 20-24 • CEI 20-62/1 • HD 629-1

**Ranges of application**  
For single core cables type



Extruded wire



Extruded tapes

For voltages 18/30 kV (U<sub>max</sub> 36 kV)



## Raytech self-retractable joints for medium voltage cables

Raytech cold shrink joints are retractable. The body of the joint, which includes integrated elements for controlling the electric field (side deflector electrodes + central electrode which makes up a Faraday cage around the connector), is composed of an insulating elastomer singleblock with very high dielectric, mechanical, elastic and thermal retentive characteristics suitable to withstand stresses during expansion, storage, installation and the life of the joint.



In its laboratories and on its production lines, Raytech has developed a sophisticated profile spiral support on which joints can dilate. The support, extruded on Raytech dies, formed to the diameter of application on special automated packaging lines, is fitted into the body of the joint.



The particular shape and profile of the support section allow for safe expansion of the joint body, avoiding harmful stresses for the duration in storage but also above all easy, light removal during installation without tearing or dangerous stresses.

Type tests are performed in the company's laboratories in accordance with standard CENELEC HD 629-1 and operating experience has demonstrated its extreme reliability and ease of assembly.

## Medium voltage testing details for terminals and joints up to 36 kV.

TEST	TEST METHOD (VOLTAGES IN kV)	MAXIMUM VOLTAGE PER CABLE UM (kV)					RESULTS
		7,2	12	17,5	24	36	
INDUSTRIAL FREQUENCY AC	a) 1 min. (dry)	27	35	45	55	75	Neither perforations nor discharges
	b) 1 min. (in the rain)	27	35	45	55	75	
	c) 4 h.	14	24	36	48	73	
PARTIAL DISCHARGES	PE, XLPE, EPR, PVC (voltages in kV)	4,5	7,5	10,9	15	22,5	< 3 pC
		7,2	12	17,5	24	-	< 20 pC
IMPULSE	a) 10 positive 10 negative 1,2/50 $\mu$ s (voltages in kV)	60	75	95	125	170	Neither perforations nor discharges
	b) 10 positive 10 negative 1,2/50 $\mu$ s (voltages in kV)	70	95	110	150	200	
THERMAL CYCLES WITH APPLIED VOLTAGE	a) 63 cycles of 5 h. of heating, 3 h. of air cooling	-	-	-	-	-	Neither perforations nor discharges
	b) 63 cycles of 5 h. of heating, 3 h. of water cooling (1 m of water head)	-	-	-	-	-	
	Extruded cable and non-migrant mixture paper cable	9	15	22	30	45	
	Migrant mixture paper cable	6,5	11	15	22	32	
THERMAL SHORT-CIRCUIT TEST	a) short-circuit of 1s f/f at maximum temperature specified for the cable	-	-	-	-	-	No visible damage
	b) short-circuit of 1s f/t at maximum temperature specified for the cable	-	-	-	-	-	
DIRECT CURRENT	30 min	28	48	72	96	144	Neither perforations nor discharges
MOISTURE TEST WITH APPLIED VOLTAGE	a) 100 h. in saturated air	4,5	7,5	10,9	15	22,5	Neither perforations nor discharges, nor visible carbonisation nor erosion
	b) 1000 h. in saturated air	4,5	7,5	10,9	15	22,5	
DYNAMIC SHORT-CIRCUIT TEST	63 kA - Standard	-	-	-	-	-	No visible damage
	125 kA - High Current	-	-	-	-	-	
IMPACT	Fall from a height of 2 m at a weight of 4 kg, 6 times (only reinforced joints)	-	-	-	-	-	
SALT SPRAY WITH APPLIED VOLTAGE	1h of sealing salinity 224 kg/m <sup>3</sup> (voltages in kV)	4,5	7,5	10,9	15	22,5	No discharge

### TESTING SEQUENCE

**Indoor terminations** 1a,2,3a, 4a,2,5, 4a, 1c, 3a,6,7a, 8

**Outdoor terminations** 1b, 2, 3b, 4a,2, 5,4a, 2, 1c,3b, 6,7b, 8, 10

**Joints** 9, 1a,2,3b,4a,2,5, 4b,2,5, 4b,2,1c,3b, 6,8

# HEAT-SHRINK

## Terminations



HEAT-SHRINK FOR INDOOR AND OUTDOOR USE



Single core terminations for **indoor use**  
For extruded cables up to 36 kV



Single core terminations for **outdoor use**  
For extruded cables up to 36 kV

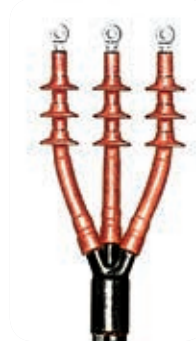

Three-core terminations for **indoor/outdoor use**  
For extruded cables up to 36 kV



ENEL **certified** terminations

## Joints

HEAT-SHRINK

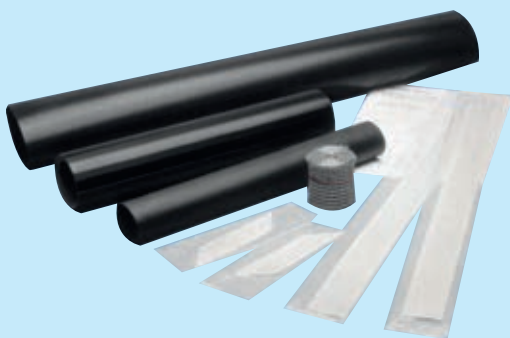

- Single core joints
- Three-core joints
- Transition joints
- ENEL **certified** joints

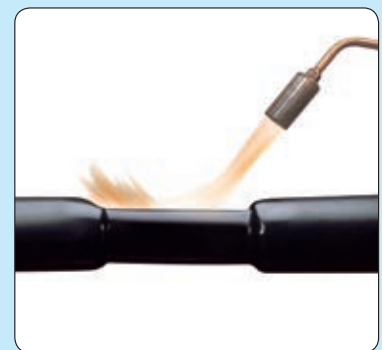

Three-core extruded cable (A) RG7H10R



Three-core paper cable (A) RC1HLOR(X)



Single core extruded cable (A) RG7H1R(X)



Single core paper cable (A) RC1HLR(X)

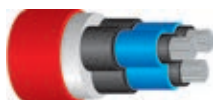



# Heat-shrink terminations

Indoor and outdoor use terminations for single core, three-core armoured and non armoured cables.

Heat-shrink terminations are immediately energizable, fast to package and reliable. High shrinkage ratios serve to broaden the ranges of application and reduce the number of kits to be put into stock.

The first problem to solve with medium voltage accessories is avoiding the concentration of voltage on the shield cutting line. The use of polymers charged with metal oxides with non-linear characteristics has allowed for optimal distribution of the electrical field without enlarging the terminal. The field control element can be a sheath to be applied directly on the cable head or an extruded layer made with external covering sheath.

- Extremely simple
- Do not require special labour
- Can be installed in all conditions
- No shelf life

### WITHOUT FIELD CONTROL

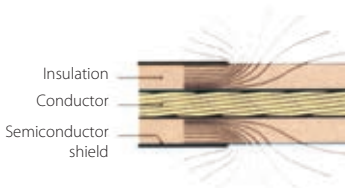

### WITH FIELD CONTROL TUBE

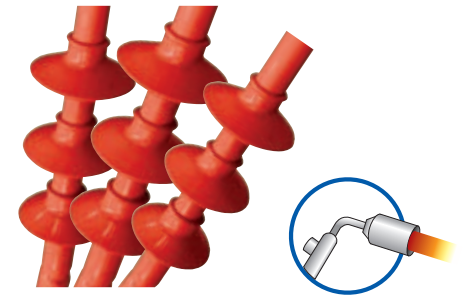
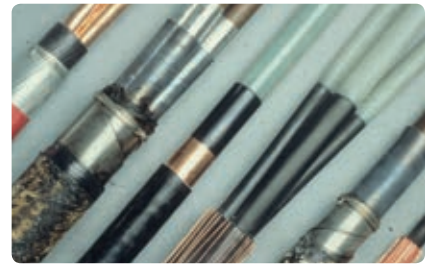
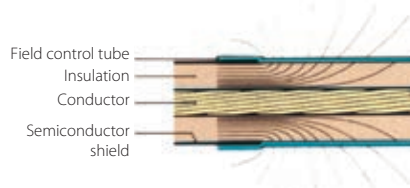

## MV TERMINATIONS

### HOW TO IDENTIFY AND ORDER COMPLEMENTARY ACCESSORIES

Accessory	Abbreviation to add to the product code		Example
Grounding braid for aluminium tube shields	<b>/H5</b>		THVE 20/A-RC/H5
Grounding braid with roll spring (only for single core)	<b>/24</b>	For cables (mm <sup>2</sup> ) up to 25	THVE 20/A-RC/24
	<b>/25</b>	from 35 to 95	THVE 20/B-RC/25
	<b>/26</b>	from 120 to 300	THVE 20/C-RC/26
	<b>/27</b>	from 400 to 630	THVE 20/C-RC/27
Copper cable terminal	<b>-C</b>	+ Conductor cross section	THVE 20/A-RC-C50
Aluminium cable terminal	<b>-CA</b>	+ Conductor cross section	THVE 20/A-RC-CA50
Shear bolt lug	<b>-CPR</b>	+ Conductor cross section	THVE 20/A-RC-CPR50
Multiple choice	With cable lug and grounding accessory, add codes		THVE 20/A-RC/24-C50



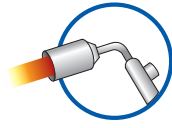

# Heat-shrink terminations for **indoor use**

Terminations for **SINGLE CORE** extruded cables up to **36 kV**.



**Electrical performance:**  
CEI 20-24 • CEI 20-62/1

**Kit composition:**  
Three single core terminations



Single core cable extruded wires



Single core cable extruded tapes

### FOR NON ARMoured CABLES

For cables (A)RG7H1R insulation thickness **FULL**

Product	Voltage U <sub>max</sub> (kV)	Conductor cross section (mm <sup>2</sup> )	Length without cable lug (mm)
THVE 6/A-RC	7,2	25 - 120	210
THVE 6/B-RC		150 - 400	210
THVE 6/C-RC		500 - 630	210
THVE 15/A-RC	12	25 - 95	320
THVE 15/B-RC		120 - 300	320
THVE 15/C-RC		400 - 630	320
THVE 15/A-RC	17,5	25 - 50	320
THVE 15/B-RC		70 - 300	320
THVE 15/C-RC		400 - 800	320
THVE 20/A-RC	24	25 - 50	320
THVE 20/B-RC		70 - 240	320
THVE 20/C-RC		240 - 630	320
THVE 30/A-RC	36	35 - 95	430
THVE 30/B-RC		120 - 185	430
THVE 30/C-RC		240 - 500	430

For shielded aluminium tube cables, add terminal abbreviation **H5**

For cables RG7H1M1Afumex insulation thickness **LOW**

Product	Voltage U <sub>max</sub> (kV)	Conductor cross section (mm <sup>2</sup> )	Length without cable lug (mm)
THVE 20/A-RC	24	25 - 120	320
THVE 20/B-RC		95 - 300	320
THVE 20/C-RC		240 - 630	320
THVE 30/A-RC	36	50 - 185	430
THVE 30/B-RC		120 - 240	430
THVE 30/C-RC		240 - 630	430



FOR CABLES ARMoured WITH WIRES OR ALUMINIUM TAPE

For Umax cables <b>7,2 kV</b>		Voltage Umax (kV)	Conductor cross section (mm <sup>2</sup> )	Length without cable lug (mm)
Product				
THVI 6/0-ARM		7,2	25 - 70	460
THVI 6/A-ARM			95 - 120	460
THVI 6/B-ARM			150 - 400	460
THVI 6/C-ARM			500 - 630	460

For Umax cables from <b>12 to 24 kV</b>		Umax 12 kV sect. (mm <sup>2</sup> )	Umax 17,5 kV sect. (mm <sup>2</sup> )	Thickness <b>FULL</b>	Thickness <b>LOW</b>	Length without cable lug (mm)
Product				Umax 24 kV sect. (mm <sup>2</sup> )	Umax 24 kV sect. (mm <sup>2</sup> )	
THVI 20/A-ARM		25 - 95	25 - 50	25 - 50	25 - 120	600
THVI 20/B-ARM		120 - 300	70 - 300	70 - 240	95 - 300	600
THVI 20/C-ARM		400 - 800	400 - 800	240 - 630	240 - 630	600

For Umax cables <b>36 kV</b>		Voltage Umax (kV)	Conductor cross section (mm <sup>2</sup> )	Length without cable lug (mm)
Product				
THVI 30/A-ARM		36	35 - 95	730
THVI 30/B-ARM			120 - 185	730
THVI 30/C-ARM			240 - 500	730

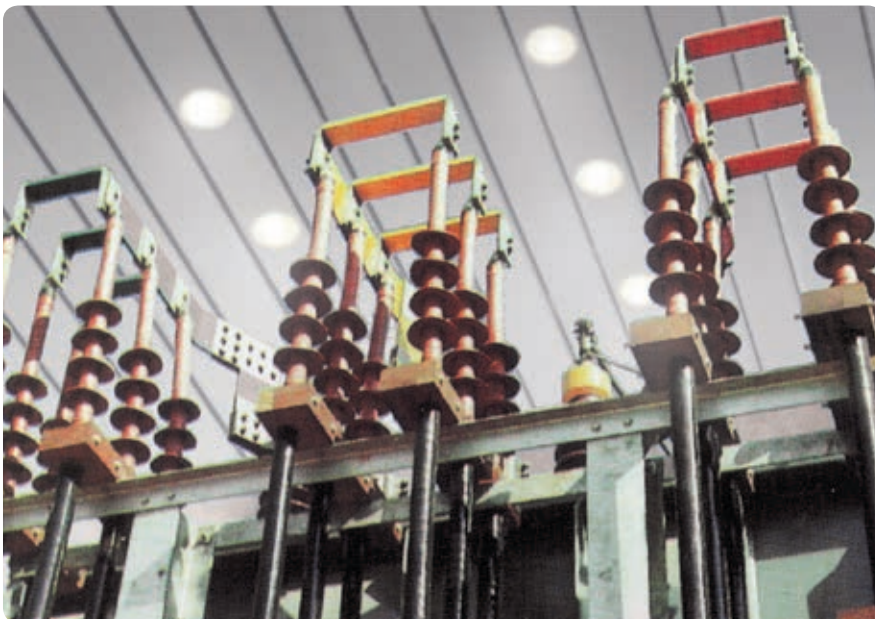

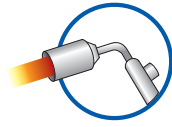

## Heat-shrink terminations for **outdoor use**

Terminations for **SINGLE CORE** extruded cables up to **36 kV**.



**Electrical performance:**  
CEI 20-24 • CEI 20-62/1

**Kit composition:**  
Three single core terminations



Single core cable extruded wires



Single core cable extruded tapes

### FOR NON ARMoured CABLES

For cables (A)RG7H1R  
insulation thickness **FULL**

Product	Voltage U <sub>max</sub> (kV)	Conductor cross section (mm <sup>2</sup> )	Length without cable lug (mm)
THVE 6/120-E	7,2	25 - 120	340
THVE 6/400-E		150 - 400	340
THVE 6/630-E		500 - 630	340
THVE 15/50-E	12	25 - 95	450
THVE 15/300-E		120 - 300	450
THVE 15/800-E		400 - 630	450
THVE 15/50-E	17,5	25 - 50	450
THVE 15/300-E		70 - 300	450
THVE 15/800-E		400 - 800	450
THVE 20/25-E	24	25 - 50	520
THVE 20/240-E		70 - 240	520
THVE 20/630-E		240 - 630	520
THVE 30/95-E	36	35 - 95	720
THVE 30/185-E		120 - 185	720
THVE 30/500-E		240 - 500	720

For shielded aluminium tube cables, add terminal abbreviation **H5**

For cables RG7H1M1Afumex  
insulation thickness **LOW**

Product	Voltage U <sub>max</sub> (kV)	Conductor cross section (mm <sup>2</sup> )	Length without cable lug (mm)
THVE 20/25-E	24	25 - 120	520
THVE 20/240-E		95 - 300	520
THVE 20/630-E		240 - 630	520
THVE 30/95-E	36	50 - 185	720
THVE 30/185-E		120 - 240	720
THVE 30/500-E		240 - 630	720



## FOR CABLES ARMORED WITH WIRES OR ALUMINIUM TAPE

For Umax cables <b>7,2 kV</b>	Voltage Umax (kV)	Conductor cross section (mm <sup>2</sup> )	Length without cable lug (mm)
Product			
THVO 6/70-ARM	7,2	25 - 70	600
THVO 6/120-ARM		95 - 120	600
THVO 6/400-ARM		150 - 400	600
THVO 6/630-ARM		500 - 630	600

For Umax cables from <b>12</b> to <b>24 kV</b>	Umax		Thickness <b>FULL</b>	Thickness <b>LOW</b>	Length without cable lug (mm)
	12 kV sect. (mm <sup>2</sup> )	17,5 kV sez. (mm <sup>2</sup> )	Umax 24 kV sect. (mm <sup>2</sup> )	Umax 24 kV sect. (mm <sup>2</sup> )	
THVO 20/25-ARM	25 - 95	25 - 50	25 - 50	25 - 120	800
THVO 20/240-ARM	120 - 300	70 - 300	70 - 240	95 - 300	800
THVO 20/630-ARM	400 - 800	400 - 800	240 - 630	240 - 630	800

For Umax cables <b>36 kV</b>	Voltage Umax (kV)	Conductor cross section (mm <sup>2</sup> )	Length without cable lug (mm)
Product			
THVO 30/95-ARM	36	35 - 95	1020
THVO 30/185-ARM		120 - 185	1020
THVO 30/500-ARM		240 - 500	1020



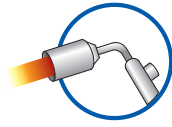

## Three-core heat-shrink terminations for indoor/outdoor use

Terminations for armoured and non armoured extruded cables up to **36 kV**.

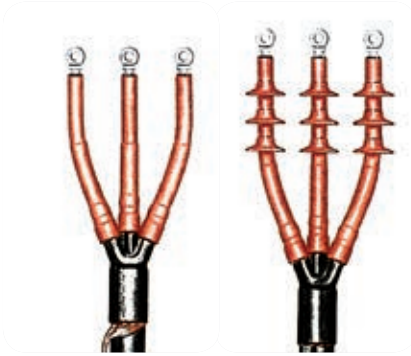

**Electrical performance:**  
CEI 20-24 • HD 629-1

Note: contact Raytech regarding smaller cable insulation thickness



Three-core cable extruded wires



Three-core cable extruded tapes

### FOR INDOOR USE

For <b>NON ARMoured</b> cables	For <b>ARMoured</b> cables	Voltage U <sub>max</sub> (kV)	Conductor cross section (mm <sup>2</sup> )	
Product	Product			
THVI 6/0-3	THVI 6/0-3-ARM	7,2	25 - 35	
THVI 6/A-3	THVI 6/A-3-ARM		50 - 120	
THVI 6/B-3	THVI 6/B-3-ARM		150 - 400	
THVI 6/C-3	THVI 6/C-3-ARM		500	

For <b>NON ARMoured</b> cables	For <b>ARMoured</b> cables	U <sub>max</sub> 12 kV sez. (mm <sup>2</sup> )	U <sub>max</sub> 17,5 kV sez. (mm <sup>2</sup> )	U <sub>max</sub> 24 kV sez. (mm <sup>2</sup> )
Product	Product			
THVI 20/A-3	THVI 20/A-3-ARM	25 - 95	25 - 50	25 - 50
THVI 20/B-3	THVI 20/B-3-ARM	120 - 300	70 - 300	70 - 240
THVI 20/C-3	THVI 20/C-3-ARM	400 - 500	400	300

For <b>NON ARMoured</b> cables	For <b>ARMoured</b> cables	Voltage U <sub>max</sub> (kV)	Conductor cross section (mm <sup>2</sup> )	
Product	Product			
THVI 30/A-3	THVI 30/A-3-ARM	36	35 - 95	
THVI 30/B-3	THVI 30/B-3-ARM		120 - 185	
THVI 30/C-3	THVI 30/C-3-ARM		240	

### FOR OUTDOOR USE

For <b>NON ARMoured</b> cables	For <b>ARMoured</b> cables	Voltage U <sub>max</sub> (kV)	Conductor cross section (mm <sup>2</sup> )	
Product	Product			
THVO 6/35-3	THVO 6/35-3-ARM	7,2	25 - 35	
THVO 6/120-3	THVO 6/120-3-ARM		50 - 120	
THVO 6/400-3	THVO 6/400-3-ARM		150 - 400	
THVO 6/500-3	THVO 6/500-3-ARM		500	

For <b>NON ARMoured</b> cables	For <b>ARMoured</b> cables	U <sub>max</sub> 12 kV sez. (mm <sup>2</sup> )	U <sub>max</sub> 17,5 kV sez. (mm <sup>2</sup> )	U <sub>max</sub> 24 kV sez. (mm <sup>2</sup> )
Product	Product			
THVO 20/25-3	THVO 20/25-3-ARM	25 - 95	25 - 50	25 - 50
THVO 20/240-3	THVO 20/240-3-ARM	120 - 300	70 - 300	70 - 240
THVO 20/630-3	THVO 20/630-3-ARM	400 - 500	400	300

For <b>NON ARMoured</b> cables	For <b>ARMoured</b> cables	Voltage U <sub>max</sub> (kV)	Conductor cross section (mm <sup>2</sup> )	
Product	Product			
THVO 30/95-3	THVO 30/95-3-ARM	36	35 - 95	
THVO 30/185-3	THVO 30/185-3-ARM		120 - 185	
THVO 30/240-3	THVO 30/240-3-ARM		240	



## ENEL certified heat-shrink terminations

For single core type indoor and outdoor use.

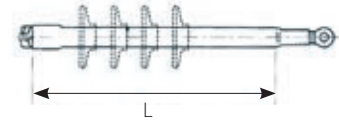

### Elicord type extruded cable (ARG7H5EXY 12/20 kV)

Product	Type	ENEL serial number	Conductor cross section (mm <sup>2</sup> )	L (mm)
THVE 20/150-I/U	With 2 INTERNAL sheaths	273047	35 ÷ 150	365
IXSU-F-5131-IT02	Single INTERNAL tube	273047	35 ÷ 150	365
THVE 20/150-E/U	With 2 EXTERNAL sheaths	273066	35 ÷ 150	450
OXSU-F-5131-IT02	Single EXTERNAL tube	273066	35 ÷ 150	450

#### Electrical performance:

CEI 20-24 • CEI 20-62/1  
ENEL tables: DJ 4456/3 • DJ 4476/2  
ENEL certification: DJ 4853 • DJ 4854



Single core cable AL extruded tube

### Extruded cable for underground installation ([A] RG7H1R 12/20 kV)

Product	Type	ENEL serial number	Conductor cross section (mm <sup>2</sup> )	L (mm)
IXSU-F-5121-IT01	Single INTERNAL tube	273045	25	360
THVE 20/185-I/U	With 2 INTERNAL sheaths	273046	50 - 185	360
IXSU-F-5131-IT01	Single INTERNAL tube	273046	50 - 185	360
THVE 20/240-I/U	With 2 INTERNAL sheaths	273048	240	360
IXSU-F-5151-IT01	Single INTERNAL tube	273049	400 - 630	360
THVE 20/185-E/U	With 2 EXTERNAL sheaths	273065	50 - 185	450
OXSU-F-5131-IT01	Single EXTERNAL tube	273065	50 - 185	450

#### Electrical performance:

CEI 20-24 • CEI 20-62/1  
ENEL tables: DJ 4456  
ENEL certification: DJ 4853 • DJ 4854



Single core cable extruded wires

### Insulated cable made of paper impregnated with stabilised mixture ([A] RC 1HLRX 12/20 kV)

Product	Type	ENEL serial number	Conductor cross section (mm <sup>2</sup> )	L (mm)
THVP 20/240-I/U	INTERNAL	273042	50 - 240	370
THVP 20/240-E/U-N1	EXTERNAL	273083	50 - 240	600

#### Electrical performance:

CEI 20-24 • CEI 20-62/1  
ENEL tables: DJ 4453 • DJ 4473  
ENEL certification: DJ 4854 • DJ 4851



Single core cable paper lead

### Extruded cable for underground installation with aluminium tube shield (ARE4H5EX 12/20 kV)

Product	Type	ENEL serial number	Conductor cross section (mm <sup>2</sup> )	Ø (mm) insulation		L (mm)
				min	max	
IXSU-F-5131-IT04	INTERNAL	273040	70 - 185	19	27	350
OXSU-F-5131-IT03	EXTERNAL	273064	70 - 185	19	27	450

#### Electrical performance:

CEI 20-24 • CEI 20-62/1  
ENEL tables: DJ4456/6 • DJ4476/7  
ENEL certification: DJ4853



Single core cable AL extruded tube



### Identification data of appropriate **termination**

#### TERMINATION

<input type="radio"/> For <b>indoor use</b>	<input type="radio"/> <b>Single core</b>	<input type="radio"/> <b>Copper conductor</b>
<input type="radio"/> For <b>external use</b>	<input type="radio"/> <b>Three-core</b>	<input type="radio"/> <b>Aluminium conductor</b>



#### NOMINAL VOLTAGE

<input type="radio"/> <b>6 kV</b> (U <sub>max</sub> 7,2)
<input type="radio"/> <b>10 kV</b> (U <sub>max</sub> 12)
<input type="radio"/> <b>15 kV</b> (U <sub>max</sub> 17)
<input type="radio"/> <b>20 kV</b> (U <sub>max</sub> 24)
<input type="radio"/> <b>30 kV</b> (U <sub>max</sub> 36)

#### CABLE INSULATION

<input type="radio"/> Extruded cable	<input type="radio"/> Full
	<input type="radio"/> Low
<input type="radio"/> Low insulation thickness	
<input type="radio"/> Belted cable	
<input type="radio"/> 3 lead paper	
<input type="radio"/> 1 lead paper with shielded phases	

#### ARMOUR

<input type="radio"/> <b>Non armoured</b>
<input type="radio"/> Armoured <b>wire</b>
<input type="radio"/> Armoured <b>tape</b>

#### SHIELD

<input type="radio"/> <b>Copper wire</b>
<input type="radio"/> <b>Copper tapes</b>
<input type="radio"/> <b>Aluminium tube</b>
<input type="radio"/> <b>Lead sheath</b>

#### CABLE SECTION

<input type="radio"/> <b>25 mm<sup>2</sup></b>
<input type="radio"/> <b>35 mm<sup>2</sup></b>
<input type="radio"/> <b>50 mm<sup>2</sup></b>
<input type="radio"/> <b>70 mm<sup>2</sup></b>
<input type="radio"/> <b>95 mm<sup>2</sup></b>
<input type="radio"/> <b>120 mm<sup>2</sup></b>
<input type="radio"/> <b>150 mm<sup>2</sup></b>
<input type="radio"/> <b>185 mm<sup>2</sup></b>
<input type="radio"/> <b>240 mm<sup>2</sup></b>
<input type="radio"/> <b>300 mm<sup>2</sup></b>
<input type="radio"/> <b>400 mm<sup>2</sup></b>
<input type="radio"/> <b>500 mm<sup>2</sup></b>
<input type="radio"/> <b>630 mm<sup>2</sup></b>

#### TYPE

<input type="radio"/> <b>Self-shrinking</b>
<input type="radio"/> <b>Heat-shrink</b>

#### INCLUDES GROUNDING BRAID

<input type="radio"/> <b>Yes</b>
<input type="radio"/> <b>No</b>



#### INCLUDES CABLE TERMINAL

<input type="radio"/> <b>Yes</b>
<input type="radio"/> <b>No</b>





# Heat-shrink joints

The preparation of cables and the installation techniques for medium voltage joints are identical to those for terminations. Even cable made with paper impregnated with non-migrant mixture up to 36 kV uses the same basic design. In this way, the heat-shrink system sets new standards regarding the effectiveness, reliability and simplicity of cable installation. The performance and ease of installation of heat-shrink materials are not affected by stocking, even if long and in adverse environmental conditions. A low number of "kits" per cable type covers the entire range of sections, allowing use with any type of connector, regardless of the type of conductor (round or sectoral) and different shields.

### Electrical field distribution

When the cable shield is cut, the electrical field is controlled by a material that has already been experimented in terminations: the electrical gradient control tube. This tube is made of non-linear impedance insulating material that is able to control the electrical field both at the end of the cable shield and on the metal connector. As with the terminations, thanks to the heat-shrink components, the range of joints includes practically all the configurations of the existing cables, as well as the joints mixed between different types of cable. The kit references that appear on the selection tables are those that are most used by national installers for cable applications up to 36 kV. In the described cases, please contact Raytech regardless of the type of cable.

### HOW TO IDENTIFY AND ORDER COMPLEMENTARY ACCESSORIES

Accessory	Abbreviation to add to the product code	Example
Copper connectors	-C + Conductor cross section	GHVE 20/185-C95
Aluminium connectors	-CA + Conductor cross section	GHVE 20/185-CA95
Shear bolt connectors	-CPR + conductor cross section	GHVE 20/185-CPR95

### Installation sequence

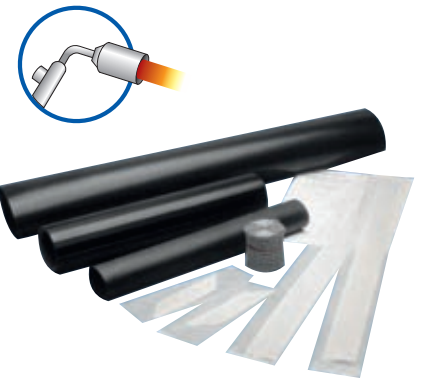
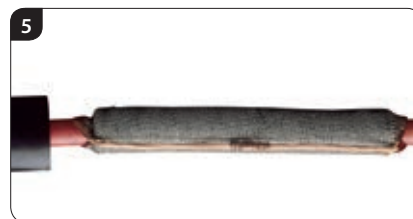
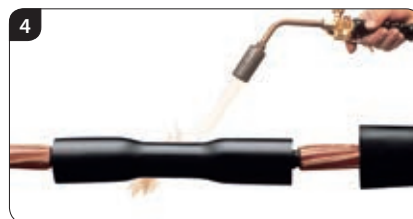

VOLTAGE DISTRIBUTION (PERCENT)  
HEAT-SHRINKABLE JOINT

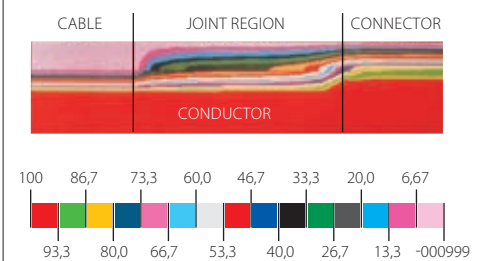

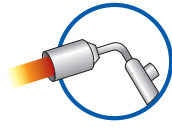

## Single core heat-shrink joints

High reliability and superior electrical, mechanical and sealing properties make these joints the ideal solution for all types of cables and installation.

### Single core heat-shrink joints for extruded insulation cables with copper wire shield

type (A)RG7H1R(X), (A)RE4H1E(X), (A)RG7H1M1(X)

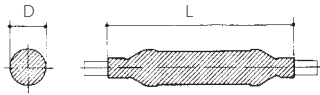

Electrical performance:  
CEI 20-24 • HD 629-1



Product	Voltage U <sub>max</sub> (kV)	Conductor cross section		L max (mm)	D max (mm)
		from (mm <sup>2</sup> )	a (mm <sup>2</sup> )		
GHVE 15/50-1	7,2 - 17,5	25	50	700	75
GHVE 15/300-1	7,2 - 17,5	70	300	700	80
GHVE 15/630-1	7,2 - 17,5	400	630	1000	100
GHVE 20/240-1	24	25	240	700	80
GHVE 20/630-1	24	240	630	1000	100
GHVE 30/240-1	36	35	240	1000	90
GHVE 30/500-1	36	300	500	1000	100

### Single core heat-shrink joints for extruded insulation cables with aluminium tube shield

type (A)RG7H5R(X), (A)RE4H5E(X), (A)RG7H5M1(X)

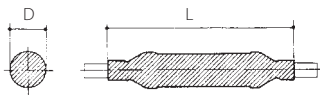

Electrical performance:  
CEI 20-24 • HD 629-1



Product	Voltage U <sub>max</sub> (kV)	Conductor cross section		L max (mm)	D max (mm)
		from (mm <sup>2</sup> )	a (mm <sup>2</sup> )		
GHVE 15/50-1-H5	17,5	25	50	700	75
GHVE 15/300-1-H5	17,5	50	300	700	80
GHVE 15/630-1-H5	17,5	400	630	1000	100
GHVE 20/240-1-H5	24	25	240	700	80
GHVE 20/630-1-H5	24	240	630	1000	100
GHVE 30/240-1-H5	36	35	240	1000	90
GHVE 30/500-1-H5	36	300	500	1000	100

### Heat-shrink terminations for single core extruded insulation cables armoured with aluminium wires

type (A)RG7H1RFR(X), (A)RE4H1EFE(X)

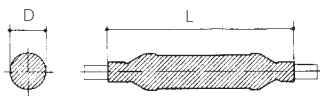

Product	Voltage U <sub>max</sub> (kV)	Conductor cross section		L max (mm)	D max (mm)
		from (mm <sup>2</sup> )	a (mm <sup>2</sup> )		
GHVE 20/240-1-ARM	24	25	240	1700	80
GHVE 20/630-1-ARM	24	240	630	1700	100
GHVE 30/240-1-ARM	36	35	240	1850	100
GHVE 30/500-1-ARM	36	300	500	1850	110

### Single core heat-shrink joints for insulated cables made of paper impregnated with mixture type (A)RC1HLR(X)

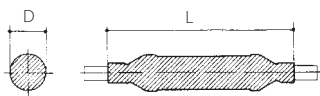

Electrical performance:  
CEI 20-24 • HD 629-2



Product	Voltage U <sub>max</sub> (kV)	Conductor cross section		L max (mm)	D max (mm)
		from (mm <sup>2</sup> )	a (mm <sup>2</sup> )		
GHVP 20/70-1	24	35	70	1000	75
GHVP 20/240-1	24	50	240	1000	75
GHVP 20/400-1	24	300	400	1000	80

Supplies do not include connectors which must be requested separately.

## Three core heat-shrink joints

High reliability and superior electrical, mechanical and sealing properties make these joints the ideal solution for all types of cables and installation.

### Three core heat-shrink joints for extruded insulation cables type (A)RG7H1OR, (A)RE4H1OR

Product	Voltage U <sub>max</sub> (kV)	Conductor cross section from (mm <sup>2</sup> ) a (mm <sup>2</sup> )		L max (mm)	D max (mm)
GHVE 15/50-3	7,2 - 17,5	25	50	1500	105
GHVE 15/300-3	7,2 - 17,5	70	300	1500	110
GHVE 15/630-3	7,2 - 17,5	400	630	1600	130
GHVE 20/240-3	24	25	240	1500	110
GHVE 20/630-3	24	300	630	1600	140
GHVE 30/240-3	36	50	240	1800	120
GHVE 30/300-3	36	300		1900	150

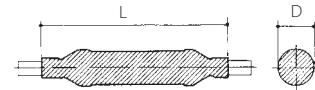
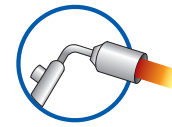

**Electrical performance:**  
CEI 20-24 • HD 629-1



### Three core heat-shrink joints for insulated armoured cables with galvanic continuity of armour

Product	Voltage U <sub>max</sub> (kV)	Conductor cross section from (mm <sup>2</sup> ) a (mm <sup>2</sup> )		L max (mm)	D max (mm)
GHVE 15/50-ARM	7,2 - 17,5	25	50	1500	75
GHVE 15/300-ARM	7,2 - 17,5	70	300	1500	110
GHVE 15/630-ARM	7,2 - 17,5	400	630	1600	130
GHVE 20/240-ARM	24	25	240	1500	110
GHVE 20/630-ARM	24	300	630	1600	140
GHVE 30/240-ARM	36	50	240	1800	120
GHVE 30/300-ARM	36	300		1900	150

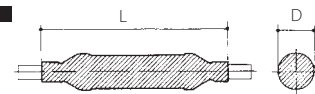

**Electrical performance:**  
CEI 20-24 • HD 629-1



Supplies do not include connectors which must be requested separately  
Note: contact Raytech for three core armoured cables with low insulation thickness

### Three core heat-shrink joints for insulated cables made of paper impregnated with mixture type (A)RC1HLOR (3 lead)

Product	Voltage U <sub>max</sub> (kV)	Conductor cross section from (mm <sup>2</sup> ) a (mm <sup>2</sup> )		L max (mm)	D max (mm)
GHVP 20/70-3	24	35	70	1600	130
GHVP 20/240-3	24	95	240	1600	140
GHVP 20/400-3	24	300	400	1600	150

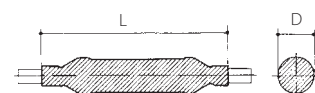

**Electrical performance:**  
CEI 20-24 • CEI 20-62/2



Supplies do not include connectors which must be requested separately

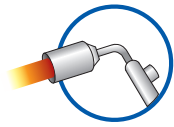

## Transition joints between single **core cables**

Transition joints between **single core** paper insulated cable and extruded cable

respectively type (A)RG7H1R(X) and single pole cable made of paper impregnated with mixture type (A)RC1HLRX

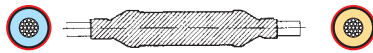

**Electrical performance:**  
CEI 20-24 • CEI 20-62/2



Product	Voltage U <sub>max</sub> (kV)	Conductor cross section (mm <sup>2</sup> )		ENEL serial number
		paper cable	extruded cable	
GHVE 20/25-1-T	24		25	-
GHVE 20/240-1-T	24	50 - 240	35 - 185	271074
GHVE 20/400-1-T	24		240 - 400	-

Supplies do not include connectors which must be requested separately

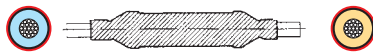

**Electrical performance:**  
CEI 20-24 • CEI 20-62/2



Transition joints between **single core** paper insulated cable and extruded cable with aluminium sheet screen

type (A)RC1HLRX and type ARG7H5EXY

Product	Voltage U <sub>max</sub> (kV)	Conductor cross section (mm <sup>2</sup> )		ENEL serial number
		paper cable	extruded cable	
GHVE 20/240-1-TE	24	50 - 240	35 - 150	270118

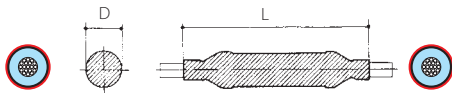

**Electrical performance:**  
CEI 20-24 • HD 629-1



Transition joints between **single core** extruded cable with wire screen and extruded cable with aluminium foil screen

type (A)RG/H1R(X) or (A)RG7H1M1 and extruded single core cable type ARG7H5EXY

Product	Voltage U <sub>max</sub> (kV)	Conductor cross section		L max (mm)	D max (mm)
		from (mm <sup>2</sup> )	to (mm <sup>2</sup> )		
GHVE 20/240-1X-TE	24	25	240	1000	75



# Transition joints between multi core cables

Transition joints between **3-core** paper insulated cable and **3 single core** extruded cables respectively type (A) RC1HLOR and (A) RG7H1R(X)

Product	Voltage U <sub>max</sub> (kV)	Conductor cross section (mm <sup>2</sup> )	
		paper cable	extruded cable
GHVT 20/25-1X-3H	24	25	25
GHVT 20/240-1X-3H	24	50 - 240	35 - 185
GHVT 20/400-1X-3H	24	300 - 400	240 - 400

Supplies do not include connectors which must be requested separately

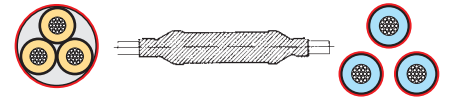
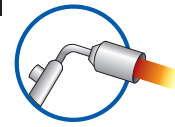

**Electrical performance:**  
CEI 20-24 • CEI 20-62/2

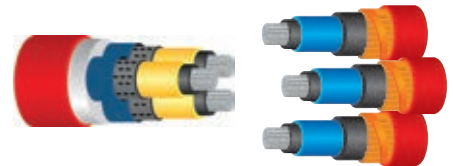

Transition joints between **3-core** extruded cable and **3 single core** paper insulated cables respectively type (A) RG7H10R and (A) RC1HLRX

Product	Voltage U <sub>max</sub> (kV)	Conductor cross section	
		from (mm <sup>2</sup> )	to (mm <sup>2</sup> )
GHVT 20/70-3X-1H	24	25	70
GHVT 20/240-3X-1H	24	95	240
GHVT 20/400-3X-1H	24	300	400

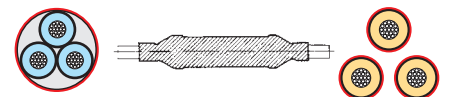

**Electrical performance:**  
CEI 20-24 • CEI 20-62/2

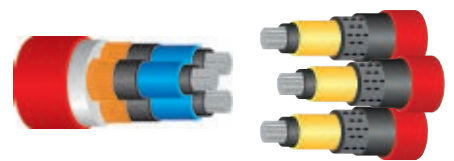

**Single core** plastic or paper insulated cable joint with screen interruption

Product	Type of cable	Voltage U <sub>max</sub> (kV)	Conductor cross section		L max (mm)	D max (mm)
			from (mm <sup>2</sup> )	to (mm <sup>2</sup> )		
GHVP 20/240-1-IS	(A)RC4HLR(X)	24	50	240	1000	75
GHVE 20/240-1-IS	(A)GR7H1R(X)	24	50	240	1000	75
GHVE 20/150-1-IS	ARG7H5EXY	24	35	150	1000	75

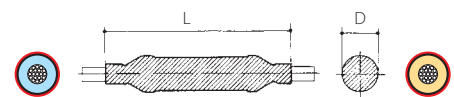

**Electrical performance:**  
CEI 20-24 • HD 629-1

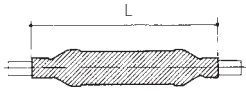
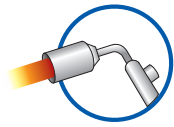

**Electrical performance:**

CEI 20-24 • CEI 20-62/1

Tabelle Enel: DJ 4376

ENEL certification: DJ 4853 • DJ 4854



## ENEL certified heat-shrink

Single core joints for extruded insulation cables

**Type (A)RG7H1RX 12/20 kV (copper wire shield - external PVC sheath)**

Product	Voltage U <sub>max</sub> (kV)	Conductor cross section from (mm <sup>2</sup> ) to (mm <sup>2</sup> )		L max (mm)	ENEL serial number
GHVE 20/185 - 1/U	24	50	185	700	271071

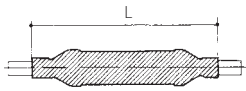
**Electrical performance:**

CEI 20-24 • CEI 20-62/1

Tabelle Enel: DJ 4376

ENEL certification: DJ 4853 • DJ 4854



Single core joints for wire carrying overhead cables

**Type ARG7H5EXY 12/20 kV (aluminium tube shield - external PE sheath)**

Product	Voltage U <sub>max</sub> (kV)	Conductor cross section from (mm <sup>2</sup> ) to (mm <sup>2</sup> )		L max (mm)	ENEL serial number
GHVE 20/150 - 1/U	24	35	150	700	271072

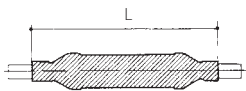
**Electrical performance:**

CEI 20-24 • CEI 20-62/2

Tabelle Enel: DJ 4373

ENEL certification: DJ 4851 • DJ 4854

Single core joints for insulated cables with  
impregnated paper**Type RC4HLRX with copper conductors from 50 to 150 mm<sup>2</sup>  
and ARC4HLRX with aluminium conductors from 95 to 240 mm<sup>2</sup>**

Product	Voltage U <sub>max</sub> (kV)	Conductor cross section from (mm <sup>2</sup> ) to (mm <sup>2</sup> )		L max (mm)	ENEL serial number
GHVP 20/150 - 1/U	17,5 e 24	50	150	1000	-
GHVP 20/240 - 1/U	17,5 e 24	95	240	1000	271042

Supplies do not include connectors which must be requested separately.

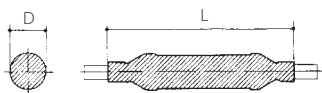
**Electrical performance:**

CEI 20-24 • CEI 20-62/1

Tabelle Enel: DJ 4387/2

ENEL certification: DJ 4853

Extruded cable for underground installation with  
aluminium tube shield (**ARE4H5EX 12/20 kV**)

Product	Voltage U <sub>max</sub> (kV)	Conductor cross section from (mm <sup>2</sup> ) to (mm <sup>2</sup> )		L max (mm)	D insulation Ø (mm)	ENEL serial number
GHVE 20/185-1X-H5	24	70	185	1000	19-30	271021

Supplies do not include connectors which must be requested separately.

Identification data of appropriate **junction****Ray  
Tech**

www.raytech.it

## CABLE DATA

- 6 kV** (U<sub>max</sub> 7,2)   
  **10 kV** (U<sub>max</sub> 12)   
  **15 kV** (U<sub>max</sub> 17)   
  **20 kV** (U<sub>max</sub> 24)   
  **30 kV** (U<sub>max</sub> 36)

**CABLE DATA 1**

## CABLE

- Single core**  
 **Three-core**

## CONDUCTOR

- Copper**  
 **Aluminium**

## CABLE INSULATION

- Extruded cable**  
 **Belted cable**  
 **3 lead paper**  
 **1 lead paper with shielded phases**

## ARMOUR

- Non armoured**  
 **Armoured wire**  
 **Armoured tape**

## CABLE SECTION

- 25 mm<sup>2</sup>**  
 **35 mm<sup>2</sup>**  
 **50 mm<sup>2</sup>**  
 **70 mm<sup>2</sup>**  
 **95 mm<sup>2</sup>**  
 **120 mm<sup>2</sup>**  
 **150 mm<sup>2</sup>**  
 **185 mm<sup>2</sup>**  
 **240 mm<sup>2</sup>**  
 **300 mm<sup>2</sup>**  
 **400 mm<sup>2</sup>**  
 **500 mm<sup>2</sup>**  
 **630 mm<sup>2</sup>**

## SHIELD

- Copper wire**  
 **Copper tapes**  
 **Aluminium tube**  
 **Lead sheath**

## INCLUDES CONNECTOR

- Yes**  
 **No**

## TYPE

- Cold-shrink**  
 **Heat-shrink**

**CABLE DATA 2**

## CABLE

- Single core**  
 **Three-core**

## CONDUCTOR

- Copper**  
 **Aluminium**

## CABLE INSULATION

- Extruded cable**  
 **Belted cable**  
 **3 lead paper**  
 **1 lead paper with shielded phases**

## ARMOUR

- Non armoured**  
 **Armoured wire**  
 **Armoured tape**

## CABLE SECTION

- 25 mm<sup>2</sup>**  
 **35 mm<sup>2</sup>**  
 **50 mm<sup>2</sup>**  
 **70 mm<sup>2</sup>**  
 **95 mm<sup>2</sup>**  
 **120 mm<sup>2</sup>**  
 **150 mm<sup>2</sup>**  
 **185 mm<sup>2</sup>**  
 **240 mm<sup>2</sup>**  
 **300 mm<sup>2</sup>**  
 **400 mm<sup>2</sup>**  
 **500 mm<sup>2</sup>**  
 **630 mm<sup>2</sup>**

## SHIELD

- Copper wire**  
 **Copper tapes**  
 **Aluminium tube**  
 **Lead sheath**

## INCLUDES CONNECTOR

- Yes**  
 **No**

## TYPE

- Cold-shrink**  
 **Heat-shrink**



# Heat-shrink terminations for **high voltage** up to 72 kV

Kit contains a limited number of components with unlimited shelf life at normal storage conditions. Three basic kits cover all possible cable sections, with the advantage of keeping a reduced and effective stock. The lightness and limited volume of the kits facilitate their handling and transport. No special additional training is required. Simple installation for reliable results. Terminations are in compliance with international specifications (for example IEEE 48, IEC 840, SEN 241434, ESI 09-16, EdF HN-62/5448/2, KEMA S10, CEI 20.24) all included in internal certification testing.

Currently available in 2 classes of HV terminations

- U<sub>o</sub>/U=26/45 kV (U max 52 kV)
- U<sub>o</sub>/U=36/60 kV (U max 72 kV)

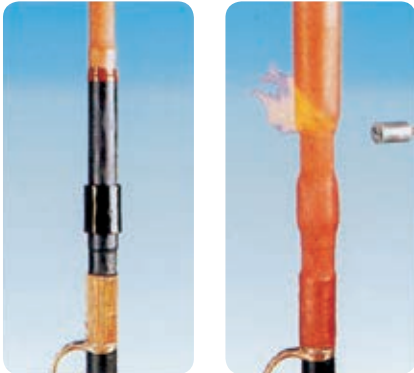
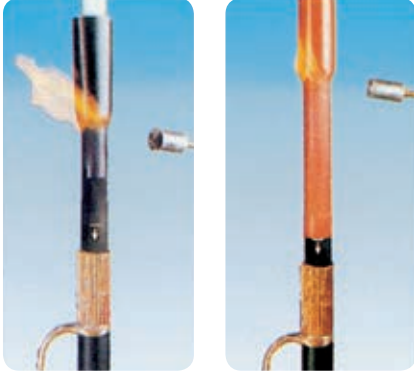
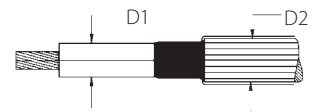

### U max 52 kV

#### FOR INDOOR

Product	Voltage U <sub>max</sub> (kV)	∅ D1 insulation (mm)	∅ D2 max. external (mm)
THVE 45/A-I	52	30 - 45	60

#### FOR OUTDOOR

Product	Voltage U <sub>max</sub> (kV)	∅ D1 insulation (mm)	∅ D2 max. external (mm)
THVE 45/A-E	52	30 - 45	60

### U max 72 kV

#### FOR INDOOR

Product	Voltage U <sub>max</sub> (kV)	∅ D1 insulation (mm)	∅ D2 max. external (mm)
THVE 60/A-I	72	32 - 40	51
THVE 60/B-I	72	38 - 52	67
THVE 60/C-I	72	50 - 65	82
THVE 60/D-I	72	63 - 77	100

#### FOR OUTDOOR

Product	Voltage U <sub>max</sub> (kV)	∅ D1 insulation (mm)	∅ D2 max. external (mm)
THVE 60/A-E	72	32 - 40	51
THVE 60/B-E	72	38 - 52	67
THVE 60/C-E	72	50 - 65	82
THVE 60/D-E	72	63 - 77	100



# Heat-shrink joints for **high voltage** 72 kV

## RELIABILITY

The simplicity and lightness of heat-shrink joints for high voltage make these a highly reliable accessory.

## SCREW CONNECTORS

These joints are provided with a special screw connector that allows you to splice large section conductors without special tools and without heat treatment. Screws have a pre-determined breakaway head which ensures perfect electrical connection.

## ELECTRICAL FIELD CONTROL

Apply a sheath with electric field control properties of the above the connector and the ends of the cable semiconductor. This heat-shrink tube is rendered conductive at the centre to shield the connector (Faraday system). The field control tube, which covers the cable dielectric, accompanies the expansion due to load cycles.

## ADVANCED TECHNOLOGY

Insulation and shielding are obtained with two double wall heat-shrink elastomeric tubes. The internal tube is formed by two walls co-extruded in insulating material (red). The external tube is formed by a co-extruded insulating wall (red) with a black conductor part which acts as the joint shield. The external wall of the co-extruded wall is heat-shrink, while the internal wall is an elastomer maintained in expanded form thanks to close union with the external part. The application of heat to the external part causes this to contract up to a predetermined diameter, at the same time allowing the internal part to perfectly adapt to the underlying layer.

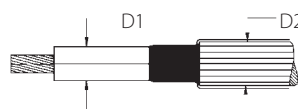

Product	Voltage U <sub>max</sub> (kV)	Ø D1 insulation (mm)	Ø D2 max. external (mm)
GEHV 40/A	42	23 - 28	40
GEHV 40/B	42	28 - 40	52
GEHV 40/C	42	38 - 55	68
GEHV 45/A	52	28 - 45	52
GEHV 45/B	52	41 - 61	72
GEHV 45/C	52	53 - 73	83
GEHV 60/A	72	34 - 45	51
GEHV 60/B	72	43 - 60	72
GEHV 60/C	72	52 - 65	77
GEHV 60/D	72	63 - 77	97

Add **SF** to code for wire shielded, **SN** for belt shielded or lead sub-sheath.

Contact Raytech to choose the most suitable joint.





Complies with standards  
CEI 20-62/1  
Cenelec HD 629.1 S2

**Kit composition:**  
One single core termination

## Single core separable connectors with external cone with contact plug $I_n=250\text{ A}$

Separable connectors for MV cables with extruded radial field for voltages up to 19/33 (36) kV.

Single core separable connectors with contact plug  $I_n=250\text{ A}$ , elbow or straight for extruded cables. External coating in semi-conductive rubber protects personnel from electrocution. Each termination is factory tested before delivery with dielectric strength testing and measurements of partial discharges.

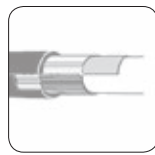

Contact Raytech for aluminium shield cables

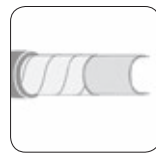

Kit available for tape screen. Add "A" to the end of the "Product code"

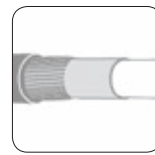

Connection kit for wire shield included



Contact Raytech for information regarding other types of cable



Kit available for three core cables. Order kit "TK." See table

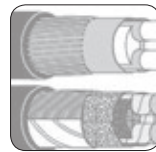

Contact Raytech for different armour grounding systems available

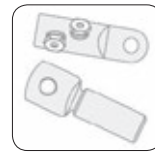

Different types of cable lugs available

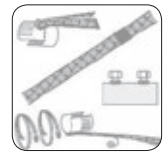

Contact Raytech about different shield grounding systems available

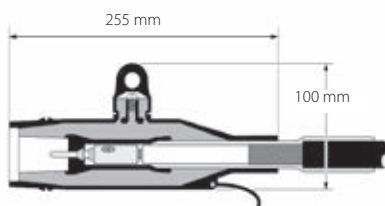
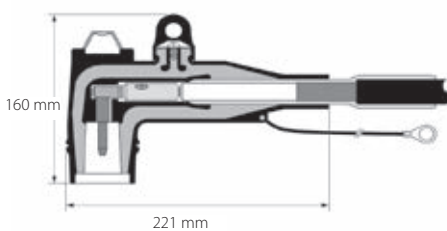

### SEPARABLE INTERFACE "A" TERMINATION 24KV - 250 A

ELBOW Product	Voltage $U_{max}$ (kV)	Cable insulation diameter range (mm)	Copper/aluminium mechanical conductor cross section range (mm <sup>2</sup> )
250 RTS-20/A	24	14,6 - 18,7	25 - 95
250 RTS-20/B	24	17,5 - 20,2	
250 RTS-20/C	24	18,4 - 21,2	
250 RTS-20/D	24	19,7 - 22,5	
250 RTS-20/E	24	21,0 - 23,8	
250 RTS-20/F	24	23,6 - 26,4	

STRAIGHT Product	Voltage $U_{max}$ (kV)	Cable insulation diameter range (mm)	Copper/aluminium mechanical conductor cross section range (mm <sup>2</sup> )
250 RTD-20/A	24	14,6 - 18,7	25 - 95
250 RTD-20/B	24	17,5 - 20,2	
250 RTD-20/C	24	18,4 - 21,2	
250 RTD-20/D	24	19,7 - 22,5	
250 RTD-20/E	24	21,0 - 23,8	
250 RTD-20/F	24	23,6 - 26,4	

# Single core separable connectors with external cone with contact screw $I_n=630/800/1250 A$

Separable connectors for MV cables with extruded radial field, for voltages up to 19/33 (36) kV.

Single core separable connectors with contact screw, for extruded cables. External coating in semi-conductive rubber protects personnel from electrocution. Each termination is factory tested before delivery with dielectric strength testing and measurements of partial discharges.



Kit available for tape screen. Add "A" to the end of the "Product code"

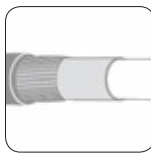

Connection kit for wire shield included



Kit available for three core cables. Order kit "TK." See table



For use in potentially explosive areas (12kV max.) Order: -/ATEX

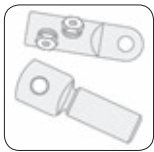

Different types of cable lugs available

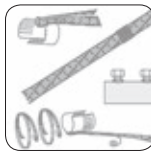

Contact Raytech for different shield grounding systems available



When installed on the appropriate bushing: 1250A continuous



When installed on the appropriate bushing: 800A continuous

## SEPARABLE TEE INTERFACE "C" TERMINATION 24/36KV - 630 A

Product	Voltage $U_{max}$ (kV)	Cable insulation diameter range (mm)	Copper/aluminium mechanical conductor cross section range (mm <sup>2</sup> )
630 RTT-20/A-C95	24	16,0 - 22,0	16 - 95
630 RTT-20/B-C150	24	20,0 - 26,5	50 - 150
630 RTT-20/C-C240	24	23,5 - 31,0	95 - 240
630 RTT-20/D-C240	24	26,5 - 32,5	95 - 240
630 RTT-20/E-C300	24	28,5 - 37,5	120 - 300
630 RTT-30/A-C95	36	16,0 - 22,0	16 - 95
630 RTT-30/B-C150	36	20,0 - 26,5	50 - 150
630 RTT-30/C-C240	36	23,5 - 31,0	95 - 240
630 RTT-30/D-C240	36	26,5 - 32,5	95 - 240
630 RTT-30/E-C300	36	28,5 - 37,5	120 - 300
630 RTO-20/A-C400	24	28,5 - 37,5	185 - 400
630 RTO-20/B-C400	24	34,0 - 42,5	185 - 400
630 RTO-20/C-C630	24	39,0 - 48,5	400 - 630
630 RTO-20/D-C630	24	45,5 - 56,0	400 - 630
630 RTO-30/A-C400	36	28,5 - 37,5	185 - 400
630 RTO-30/B-C400	36	34,0 - 42,5	185 - 400
630 RTO-30/C-C630	36	39,0 - 48,5	400 - 630
630 RTO-30/D-C630	36	45,5 - 56,0	400 - 630



Complies with standards CEI 20-62/1 Cenelec HD 629.1 S2

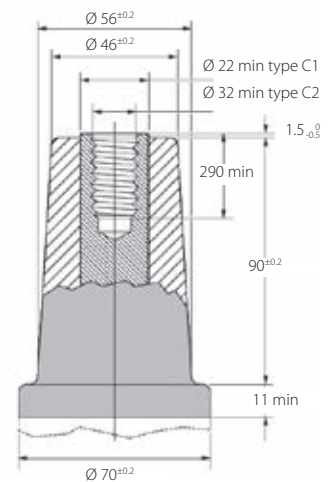

### Kit composition:

Three single core terminations

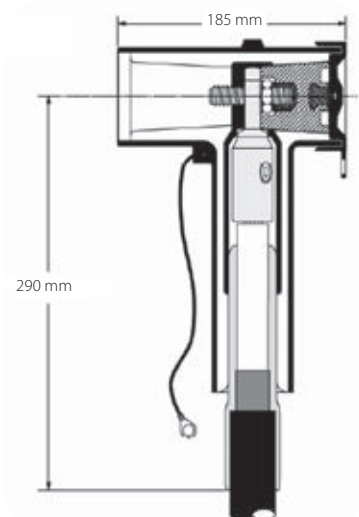

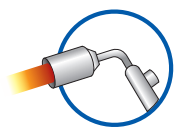

## Heat-shrink sheaths

Sheaths for insulating bars inside electrical cabinets or outdoors in primary or secondary cabinets.

### APPLICATION

Primary (HV-MV) and secondary (MV-LV) electrical up to 36 kV today come in very compact sizes. Bars need to be insulated to prevent surface discharges and accidental short-circuits that are essentially caused by animal intrusion.

Heat-shrink sheaths for MV can be used on round and rectangular copper or aluminium bars. They are flexible and elastic, can be installed on previously bent bars without any risks of tearing or rippling.

### DESCRIPTION

Sheaths utilise a special elastomer cross-linked by irradiation, with an exceptional insulating power and excellent seal over time, even in case of continuous use at high temperature. They do not contain halogens and therefore there is no risk of emission of toxic or corrosive substances in case of fire. They are resistant to solvents, UV radiation, exposure to weather, impact and tear, and therefore are fully suitable for use outdoors.

### INSTALLATION

Sheaths for MV can be easily factory installed, when dealing with mass production, using an oven for heat-shrink. In situ, shrinking can be carried out with the aid of a torch or a hot air torch. Heat the sheath to over 120°C and it will shrink on the bar without risk of damage because the material is cross-linked and very resistant to high temperatures. The great elasticity of the sheaths allows, if necessary, for being of the bars during assembly of the electric cabinet with the sheath already installed.



D =  $\varnothing$  minimum before shrinkage  
 d =  $\varnothing$  maximum after free shrinkage  
 S1 = nominal thickness as supplied  
 S2 = minimum nominal thickness after free shrinkage

## BBT

Flexible, **heavy duty** heat-shrink sheath.

Suitable for reducing overhead distances in MV panels up to 36 kV.  
 Phase-to-phase distance reduced to approximately 1/3

Product	Size of bus bars (mm)				Heat-shrink sheath (mm)			
	A+B		C		D	d	S <sub>1</sub>	S <sub>2</sub>
BBT 40/16-A/U	28	45	18	32	40	16	1,6	3,8
BBT 65/25-A/U	44	69	28	47	65	25	1,6	3,9
BBT 100/40-A/U	69	102	44	72	100	40	1,6	4,0
BBT 150/60-A/U	102	148	65	105	150	60	1,6	4,0

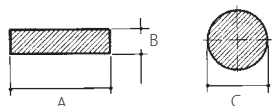



# BPM

Flexible, **medium wall** heat-shrink sheath.

Suitable for optimising space in MV panels and for protection from discharges and accidental contact for systems up to 24 kV. Phase-to-phase distance reduced to approximately 1/2

Product	Size of bus bars (mm)				Heat-shrink sheath (mm)			
	A+B		C		D	d	S <sub>1</sub>	S <sub>2</sub>
BPM 15/6-A/U	12	20	6,5	12	15	6	1,1	2
BPM 30/12-A/U	20	38	13,5	25	30	12	1,1	2,2
BPM 50/20-A/U	36	65	22	43	50	20	1,1	2,4
BPM 75/30-A/U	55	95	33	63	75	30	1,1	2,4
BPM 120/50-A/U	90	165	55	105	120	50	1,3	2,8

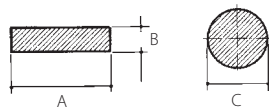

D = Ø minimum before shrinkage  
 d = Ø maximum after free shrinkage  
 S<sub>1</sub> = nominal thickness as supplied  
 S<sub>2</sub> = minimum nominal thickness after free shrinkage

## DISTANCES ALLOWED IN BAR SYSTEMS

Phase/phase and phase/bus bars distances recommended with insulated bars with sheaths for MV. Studies and testing carried out on insulated bars have shown that it is possible to significantly reduce space with respect to those used in the case of air insulation. The minimum permitted space is defined by the absence of partial discharges at the time of testing in alternating current and by the seal upon impulse. The values shown can be applied to round or rectangular bars installed inside standard cabinets. Shapes with sharp edges or bar parallels of more than 5 m require larger spaces.

### Round bus bars

Voltage Um (kV)

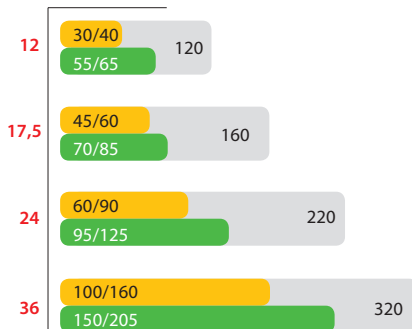

### Rectangular bus bars

Voltage Um (kV)

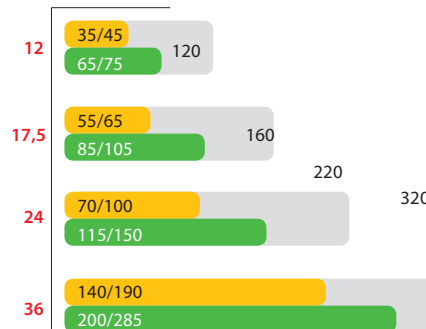

 Spacing in air according to IEC 71-2 phase / phase (mm) phase / bus bars (mm)  
 Insulation with BBT  
 Insulation with BPM or HVBT with overlap of 2/3

For more information on different possible applications please contact Raytech.



D = Ø minimum before shrinkage  
 d = Ø maximum after free shrinkage  
 S1 = nominal thickness as supplied  
 S2 = minimum nominal thickness after free shrinkage

## BPTM

Flexible, **medium wall** heat-shrink sheath.

Suitable for optimising space in MV panels and for protection from discharges and accidental contact for systems up to 24 kV. Phase-to-phase distance reduced to approximately 1/2

Product	Size of bus bars (mm)				Heat-shrink sheath (mm)			
	A+B		C		D	d	S <sub>1</sub>	S <sub>2</sub>
BPTM 15/6-A/U	12	20	6,5	12	15	6	1,1	1,9
BPTM 30/12-A/U	20	38	13,5	25	30	12	1,1	2,2
BPTM 50/20-A/U	36	65	22	43	50	20	1,1	2,35
BPTM 75/30-A/U	55	95	33	63	75	30	1,1	2,35
BPTM 100/40-A/U	70	130	44	86	100	40	1,1	2,35
BPTM 120/50-A/U	90	165	55	105	120	50	1,3	2,8
BPTM 175/70-A/U	125	235	80	150	175	70	1,3	2,8
BPTM 205/110-A/U	200	276	127	190	205	110	1,3	2,8

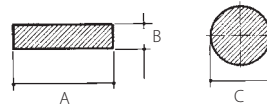

D = Ø minimum before shrinkage  
 d = Ø maximum after free shrinkage  
 S1 = nominal thickness as supplied  
 S2 = minimum nominal thickness after free shrinkage

## BBIT

Flexible, **heavy duty** heat-shrink sheath.

Suitable for reducing overhead distances in MV panels up to 36 kV. Phase-to-phase distance reduced to approximately 1/3

Product	Size of bus bars (mm)				Heat-shrink sheath (mm)			
	A+B		C		D	d	S <sub>1</sub>	S <sub>2</sub>
BBIT 25/10-A/U	17	28	11	20	25	10	1,6	3,6
BBIT 40/16-A/U	28	45	18	32	40	16	1,6	3,6
BBIT 65/25-A/U	44	69	28	47	65	25	1,6	3,6
BBIT 100/40-A/U	69	102	44	72	100	40	1,6	3,6
BBIT 150/60-A/U	102	148	65	105	150	60	1,6	3,6
BBIT 175/80-A/U	133	196	85	125	175	80	1,6	3,6

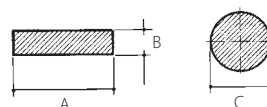

## Heat-shrink tapes

HVBT heat-shrink tape coated in hot melt adhesive for MV.

### APPLICATION

HVBT tape is part of the bar insulation product range. It is a heat-shrink tape coated with a hot melt adhesive on one side.

### INSTALLATION

HVBT is installed wrapping it moderately taut on the bar with overlap equal to 2/3. When heated, it shrinks and adheres to the underlying layer. At the same time, the layers of this tape amalgamate to create a continuous insulation sheath.

### INSULATION DISTANCE

Refer to the table on page 179 (BPM values) to determine the distances between the bars and toward grounding. HVBT tape is sold in 4 different widths and is coated with adhesive on the outer part. Fibreglass tape used to stop taping is provided with each roll.

## HVBT

Self-sealing heat-shrink tape for MV bar insulation.

Product	Width (mm)	Length (m)
HVBT 12-A	25	10
HVBT 14-A	50	10
HVBT 15-A	75	10
HVBT 16-A	100	10

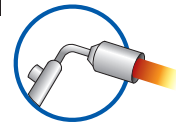



## DOMESTIC USE



*ANTI-FREEZE FOR PIPING*  
*ANTI-FREEZE FOR RAMPS*  
*ANTI-FREEZE FOR GUTTERS*

page

208



# Heating Cables



## INDUSTRIAL USE



*MCA  
MCA-I-GF  
MCA-I-FF*

221



## HOME COMFORT USE



*FOR FLOORING  
REAR-MIRROR  
FOR CEILINGS*

231



# Heating cables

Heating cables are used for frost protection of pipes, tanks, ramps and walkways, gutters, etc., or for maintaining process temperatures, especially in industrial environments.

There are 2 types:

- **CONSTANT POWER CABLES**, in which the heating element is the conductor through which the current passes, and serves as filament.
- **SELF-REGULATING CABLES**, whose heating element is the conductive core, powered by 2 conductors.

## CONSTANT POWER CABLES

Raytech cables are composed of 2 conductors that are shielded and in the case of Stop Ice (see pg. 206) are supplied with a suitable thermostat for anti-freeze maintenance.

### ADVANTAGES

#### CONSTANT POWER CABLE

- Ready for use, without requiring the installation of accessories.
- Already equipped with a thermostat, in the case of Stop Ice.
- Completely reliable.





## SELF-REGULATING HEATING CABLES

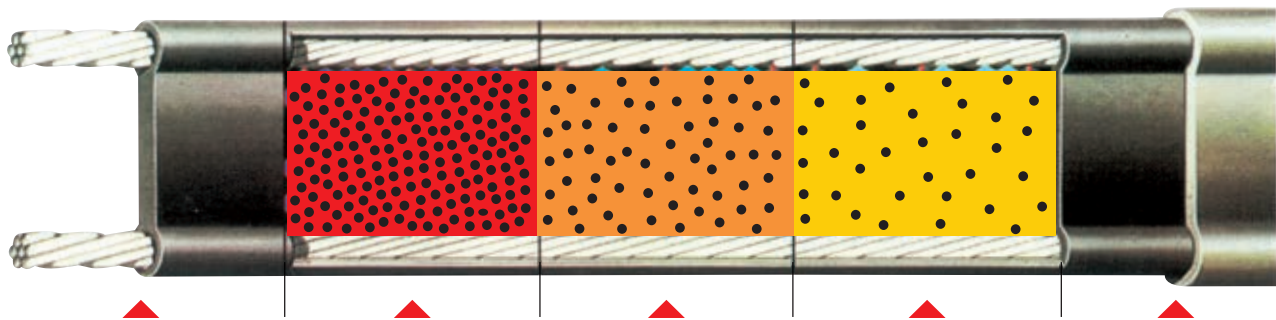

The cable will never become overheated and burn, as it is self-protecting. There is also no need for a thermostat.

Almost all the contacts are interrupted by microscopic dilatation of the core at very high temperatures. The electrical resistance becomes very high and energy output is virtually nil.

The core dilates microscopically in the hotter parts, breaking some of the electrical contacts. As the electrical resistance increases energy output is reduced until a thermal balance is reached between heat loss in the pipes and the heat produced by the cable.

The core contracts microscopically when the heating cable is cold and the graphite forms numerous joints between the conductors. The passage of the current generates heat.

The graphite particles form numerous parallel joints between the two copper conductors.

**The self-regulation technology and the parallel circuit present the following advantages:**

- The heating cables can be cut at the right length, jointed and terminated on site.
- They can be supplied at 230 V without transformers.
- They can be overlapped without over heating risks.
- They reduce automatically their power output as the required temperature is reached.
- They are easy designed and can be easily handled on site.

### ADVANTAGES

#### SELF-REGULATING HEATING CABLES

- A reduction in overall installation costs
- Reduction in operating cost
- Very easy to install
- Simple design
- Uniform temperature
- Complete reliability



# DOMESTIC USE

## Anti-freeze for Piping

CONSTANT POWER

page  
210



### Stop Ice

Constant power anti-freeze kit complete with thermostat and plug



### Linus

Self-adhesive thermal insulating tape



### Stop Ice Plus

Constant power anti-freeze kit complete with thermostat, connection plug and insulation tape

## Anti-freeze for Ramps

CONSTANT POWER

page  
215



### Easy Cable

Constant power heating cable for access ramps to boxes, walkways, etc.



### Easy Ramp

Heating mat

SELF-REGULATING



### MCA Ramp

Self-regulating heating cable for tracing ramps and stairways





SELF-REGULATING



MCA

Self-regulating cable for anti-freeze use or for maintaining temperatures for general use



MCA Compact

Compact size self-regulating cables for use as anti-freeze or to maintain temperature



Ice Killer

Cut and install self-regulating cable kit, complete with connection side and termination kit

# Anti-freeze for Gutters

CONSTANT POWER

page  
218



Easy Frost

Constant power heating cable for roofs, gutters and downpipes



SELF-REGULATING

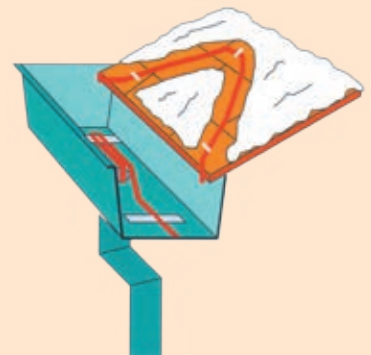

MCA 8

Self-regulating cable for tracking roofs, gutters and/or downpipes



## ANTI-FREEZE FOR PIPING

To keep pipes, tanks, basins, valves and taps, meters, etc. from freezing. Available both in the constant power and in the self-regulating versions.



**Power:** 12 W/m  
**Power supply:** 230 V – 50 Hz  
**Cable dimensions:** ~ 5x7 mm  
**Min. installation temperature:** +5°C  
**Max. working temperature:** +70°C  
**Heating cable type:**  
 2 conductors, screened cable  
**Insulation:** XLPE  
**External sheath:** PVC  
**Min. bending radius:** 3,5 D  
**Protection degree:** IP X7  
**Marking:** CE



Integrated Bimetal Thermostat  
(ON + 3°C - OFF +10°C)



Complete Connections  
and power cord  
(1,5 m - 3 x 0,75 mm<sup>2</sup>)

## Stop Ice

**Constant power** anti-freeze kit complete with thermostat and plug.

Raytech Stop Ice is an innovative pre-assembled kit consisting of a constant wattage heating cable of 12 W/m, complete with contact thermostat (installed on the end of the heating cable) and power cable with plug. Stop-Ice is particularly suitable for frost protection, and prevention of possible damages caused by low temperatures on pipes, valves, faucets, water meters, troughs, bowls and small tanks.

- Easy and quick to install
- No need for any external temperature control system, thanks to its built-in thermostat
- Low energy consumption

Product	Power (W/kit)	Specific power (W/m)	Length (m)
Stop Ice 2/12	24	12	2
Stop Ice 5/12	60	12	5
Stop Ice 10/12	120	12	10
Stop Ice 18/12	216	12	18



# Linus

Self-adhesive thermal insulating tape.

To offer a complete solution in the field of electrical tracking, Raytech has developed a new product, LINUS, an insulation tape to maintain temperature. The product is a closed-cell expanded synthetic rubber, low thermal conductivity and extremely flexible tape. The rubber tape is coupled with an aluminium sheet to protect against tearing, for greater resistance to perforation and higher tensile resistance. It also protects very well against UV radiation. The tape is self-adhesive for easy application on tracked pipes. The closed cells and the special material type give the tape very high insulating properties and optimal behaviour in the presence of condensation.

Product	Width (mm)	Thickness (mm)	Length (m)
LINUS	50	3	10
	Pipe Ø ¾" (DN 20)	Pipe Ø 1" (DN 25)	Pipe Ø 1 ¼" (DN 32)
LENGHT OF PIPE I can insulate with 1 LINUS tape 50% overlapped	2,2 m	1,9 m	1,6 m



50 mm      3 mm



Density: 0,7  
 Temperature range: -50°C -105°C  
 Coefficient of thermal conductivity (λ): 0,039 W/mK a 50°C  
 Flame resistance: Bs3-d0 (DIN EN 13501-1)

# Stop Ice Plus

Constant power anti-freeze kit complete with thermostat, connection plug and insulation tape.

Stop Ice Plus is an innovative kit which combines the flexibility and reliability of the constant power Stop Ice heating cable with the practicality of the LINUS insulation tape. The installer can find everything necessary for tracking inside this kit:

- Stop Ice 12 W/m constant power cable, complete with connection plug and thermostat
- 3 mm LINUS insulation tape, for application on already tracked piping with a cable with 50% overlap

As an example, with a 10 m long LINUS tape, about 2.2 m of ¾", traced with the Stop Ice cable, can be insulated.

Product	Power (W/kit)	Cable length (m)
Stop Ice Plus 2	24	2
Stop Ice Plus 5	60	5

HEATING CABLE  
 Built-in THERMOSTAT  
 Built-in PLUG



TAPE INSULATION  
 to maintain  
 temperature



**CABLE**  
 Specific power: 12 W/m  
 Power supply: 230 V- 50Hz  
 Cold cable: 3 x 0,75 mm<sup>2</sup> - L = 1,5 m  
 Temperature control: integrated bimetallic thermostat  
 ON / OFF: +3°C / +10°C

**INSULATION TAPE**  
 Temperature range: -50 / +105°C  
 Coefficient of thermal conductivity (λ): 0,039 W/mK a 50°C  
 Dimensions: 50 mm x 3 mm x L10 m





# MCA

**Self-regulating** cable for anti-freeze use or for maintaining temperatures for general use.

For anti-freeze use on pipes or tanks or for maintaining process temperatures under 65°C, even in hazardous areas. Maintenance-free, reliable, easy to install. Suitable even in the presence of mild inorganic solutions.

Product	Power voltage (V)	Minimum installation temperature (°C)	Power at 10°C (W/m)	TEMPERATURE MAX	
				Continuous cable powered (°C)	Intermittent cable not powered ≤1000 h cum. (°C)
MCA3	220-240	-30	10	65	85
MCA5	220-240	-30	15	65	85
MCA8	220-240	-30	25	65	85
MCA5-SMALL	220-240	-30	15	65	85

### How to Choose MCA Cable for Antifreeze Protection

The table gives the cable quantity for tube length unit (1st number) and the MCA cable code number (2nd number) versus tube diameter, thermal insulation thickness (for rockwool) and min outer temperature.

For uses other than anti-freeze, request design from Raytech technical direction.

### Anti-freeze for piping

Pipe Ø		Thermal insulation thickness									
		10		20		30		40		50	
		Outer temperature (°C)									
inch	mm	-10	-20	-10	-20	-10	-20	-10	-20	-10	-20
1/2"	15	1-3	1-3	1-3	1-3	1-3	1-3	1-3	1-3	1-3	1-3
3/4"	20	1-3	1-3	1-3	1-3	1-3	1-3	1-3	1-3	1-3	1-3
1"	25	1-3	1-8	1-3	1-3	1-3	1-3	1-3	1-3	1-3	1-3
1¼"	32	1-3	1-8	1-3	1-3	1-3	1-3	1-3	1-3	1-3	1-3
1½"	40	1-3	1-8	1-3	1-3	1-3	1-3	1-3	1-3	1-3	1-3
2"	50	1-8	1-8	1-3	1-8	1-3	1-3	1-3	1-3	1-3	1-3
2½"	65	1-8	1-8	1-3	1-8	1-3	1-3	1-3	1-3	1-3	1-3
3"	80	1-8	2-8	1-3	1-8	1-3	1-5	1-3	1-3	1-3	1-3
4"	100	1-8	2-8	1-5	1-8	1-3	1-5	1-3	1-5	1-3	1-3
6"	150	2-8	2-8	1-8	2-8	1-8	1-8	1-3	1-8	1-3	1-8
8"	200	2-8	-	1-8	2-8	1-8	1-8	1-8	1-8	1-3	1-8
10"	250	2-8	-	2-8	-	1-8	2-8	1-8	1-8	1-8	1-8

### ELECTRICAL SIZING

		Maximum length of the circuits in the heating cable (m)					
		MCA3			MCA5		
Starting temperature		+10°C	-10°C	-20°C	+10°C	-10°C	-20°C
Switchgear protection (A), with C curve and 30mA* differential protection	10 A	-	-	-	103	71	62
	16 A	177	144	125	160	114	99
	20 A	-	149	139	-	133	124
	25 A	-	-	-	-	-	-
Starting temperature		MCA8			MCA5-SMALL		
		+10°C	-10°C	-20°C	+10°C	-15°C	-25°C
Switchgear protection (A), with C curve and 30mA* differential protection	10 A	64	47	37	104	69	59
	16 A	103	75	60	139	89	78
	20 A	126	94	75	-	-	-
	25 A	-	107	94	-	-	-

\* Suggested where protection of people is requested; installations with no personnel admittance can be performed with 100 to 300 mA.





# MCA Compact

Compact size **self-regulating** cables for use as anti-freeze or to maintain temperature.

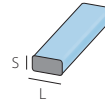

Product	Power voltage (V)	Minimum installation temperature (°C)	Power at 10°C (W/m)	TEMPERATURE MAX		L cable (mm)	S cable (mm)
				Continuous cable powered (°C)	Intermittent cable not powered ≤1000 h cum. (°C)		
MCA2-COMPACT	230	-30	10	65	65	7,7	5,3
MCA6-COMPACT	230	-30	18	65	65	7,7	5,3

ELECTRICAL SIZING

Starting temperature	Switchgear protection (A), with C curve and 30mA* differential protection	Maximum length of the circuits in the heating cable (m)					
		MCA2-COMPACT			MCA6-COMPACT		
		+10°C	0°C	-20°C	+10°C	0°C	-20°C
	10 A	100	95	77	60	58	41

\* Suggested where protection of people is requested; installations with no personnel admittance can be performed with 100 to 300 mA.

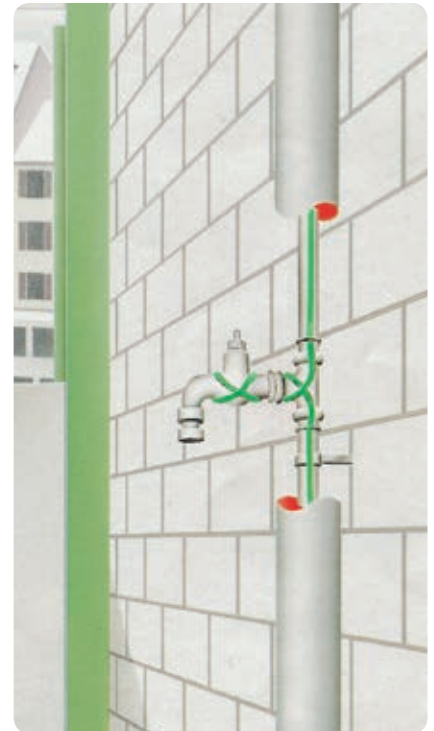

## MCA and MCA2-COMPACT connection accessories

Connection kit integrated with the terminal box	Termination Kit	Joint Kit	Branch Kit
MCA Universal IP68	MCA Universal IP68	MCA Universal IP68	MCA-Y
Thermal insulation pass-through kit	Cable gland		Warning label
MCA-AL	MCA-PRESS		MCA-EA
Fixing tape glass	Fixing tape Aluminum 25mm		Fixing tape Aluminum 75mm
MCA-FV	MCA-ALL25		MCA-ALL75



See accessory specifications page 226.



# Ice Killer

Cut and install **self-regulating** cable kit, complete with connection side and termination kit.

The Ice Killer kit is composed of a 30 m self-regulating cable coil, complete with connection side and termination accessories. The cable can be cut to the desired length, installed on the pipe or tank, connected to the mains and terminated at the opposite end.

The economic and compact Ice Killer kit is sold in an attractive, easy to carry, easy to handle on-site package, is small in size, very flexible and can be easily adapted to bends in piping.

The Ice Killer cable is laid linearly or wound in piping, depending on the specific necessary power. It is then fastened to the same by means of inextensible tape (Raytech MCA-FV or MCA-ALL75 type tapes), terminated with accessories contained in the kit and then clad with the insulation. Operating temperature is reached very quickly and is maintained almost constant even with room temperature variations.



**Supply voltage:** 230 V  
**Min installation temperature:** -30°C  
**Cable dimensions:** 7,7 x 5,3 mm  
**Max temperature with powered cable:** 65°C  
**Max exposure temperature with non-powered cable:** 65°C



Product	Specific power a 10°C (W/m)	Kit composition
Ice Killer 2	10	30 m cable Connection accessory Termination accessory
Ice Killer 6	18	30 m cable Connection accessory Termination accessory

ELECTRICAL SIZING	Maximum circuit length (m)			
	Ice Killer 2		Ice Killer 6	
Starting temperature	0°C	-20°C	0°C	-20°C
10 A electrical protection, characteristic C switch with differential 30 mA protection	95	77	58	41





### ANTI-FREEZE FOR RAMPS

Constant power

## Tracking Systems

# ANTI-FREEZE FOR GUTTERS AND PIPING

## Easy Cable

Constant, versatile power heating cable complete with termination accessory and power cable.

Especially suitable for solving anti-freeze problems: snow or ice accumulation on access ramps, walkways and stairs, or for frost protection of pipes or tanks, under adequate insulation. 3 standard lengths are available, with a specific power of 25 W/m, covering all possible tracking types. Complete with termination accessory and power cable, Easy cable is a shielded heating cable under a protective sheath with two conductors, with extremely simple and quick installation and connection. Please note that the cable should never be cut, spliced or overlapped.



**Power supply:** 230 V, 50/60 Hz  
**Cable dimensions:** ~ 5x7 mm  
**Min. installation temperature:** +5°C  
**Max. working temperature:** +80°C  
**Heating cable type:**  
 2 conductors, screened cable  
**Specific power:** 25 W/m  
**Insulation:** XLPE  
**External sheath:** PVC  
**Marking:** CE

**FOR RAMPS** - installation depth about 50 mm with respect to the surface.

Product	Specific power (W/m)	Length (m)	Rated power (W)	Maximum length for each individual wheel passage	
				(A) 4 passages	(B) 5 passages
Easy Cable 26/25	25	26,5	655	6 m	5 m
Easy Cable 44/25	25	44	1120	10,5 m	8,5 m
Easy Cable 92/25	25	92	2270	22,5 m	18 m

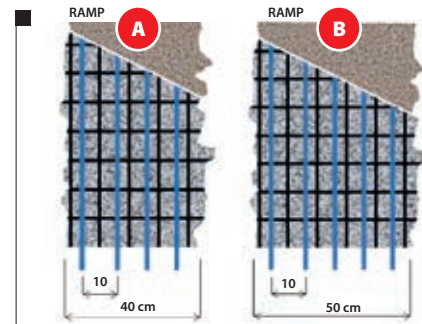

**FOR PIPES** - anti-freeze tracking for piping, longitudinal linear installation 1 m cable/m pipe.

Product	Specific power (W/m)	Total rated power (W)	Anti-freeze for pipes up to 2 1/2" (Dn 65 mm), for minimum temperatures up to -15°C, with rock wool thickness	Anti-freeze for pipes from 3" (Dn 80) up to 6" (Dn 200 mm), for minimum temperatures up to -15°C, with rock wool thickness
Easy Cable 26/25	25	655	10 mm	20 mm
Easy Cable 44/25	25	1120	10 mm	20 mm
Easy Cable 92/25	25	2270	10 mm	20 mm

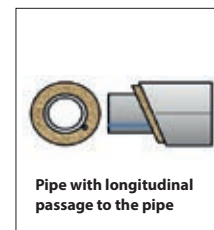

## Control unit for Easy Cable for ramps.

The C 2000 control unit, to be completed with the C2000-SR temperature, snow and humidity sensor (sensor to be placed flush with the ramp and to be ordered separately from the control unit), activating the power contactor, gives consent to start the system only when low temperature and snow or ice are present simultaneously, optimising energy consumption.

Control unit	Temperature, snow and humidity sensor
C2000	C2000-SR



Ray Tech



## Tracking systems

# ANTI-FREEZE FOR RAMPS, STEPS AND WALKWAYS

To keep garage access ramps, parking areas, outdoor stands and walkways free of snow and ice.

Available in both the **constant power** and in the **self-regulating** versions.



**Mat specific power:** 300 W/m<sup>2</sup>  
**Power supply:** 230 V ~ 50/60 Hz  
**Mat thickness:** 7,5 mm  
**Min. installation temperature:** + 5°C  
**Max. working temperature:** + 80°C  
**Cold cable (supply):**  
 length 4 meters - 3 x 1,5 mm<sup>2</sup> or 3x2,5 mm<sup>2</sup>  
**Heating cable type:**  
 2 conductors, screened cable  
**Heating cable dimensions:** ~ 5 x 7 mm  
**Heating cable power:** 25 W/m  
**Insulation:** XLPE  
**External sheath:** PVC  
**Marking:** CE

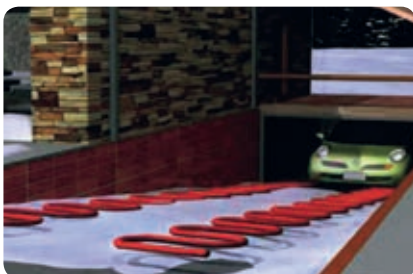

## Easy Ramp

**Constant wattage** heating mat.

Raytech Easy Ramp consists of a constant wattage heating cable assembled with tape to form a heating mat, which is easily and quickly spread on the surfaces to be protected. Easy Ramp is ideal for solving the problems caused by ice formation and the accumulation of snow on the access ramps to garages, pathways, outdoor parking areas, footpaths, etc. It can be installed in concrete, asphalt, and interlocking bricks or under porphyry paving or other paving materials blocked with cement and sand. The standard width of Easy Ramp pads is 60 cm; a sufficient width to free the track of vehicle wheels from ice and snow or to create an extremely safe pedestrian pathway.

The power density developed by Easy Ramp is 300 W/m<sup>2</sup>. The mat is available in various lengths which are easily adaptable to the size of the area to track and where the size of the mat is larger than that of the ramp, the excess part of mat can be easily folded 90 degrees. The mat is supplied completely finished and ready for installation, complete with 4 meters of cold cable (3x1.5 mm<sup>2</sup> or 3x2.5 mm<sup>2</sup>) for connection to the power supply. The constant wattage heating cable, which constitutes the mat, is a 2 conductor heating cable, which is shielded; this allows one end only to be powered, making installation even faster and easier.

Product	Power (W)	Specific power (W/m <sup>2</sup> )	Width (m)	Length (m)
Easy Ramp 4/300	670	300	0,6	4
Easy Ramp 7/300	1140	300	0,6	7
Easy Ramp 13/300	2560	300	0,6	13
Easy Ramp 21/300	3730	300	0,6	21





# MCA Ramp

## Self-regulating heating cable.

The cable is used, buried in concrete, to prevent the accumulation of ice and its formation on access ramps, stairs, sidewalks, parking lots, walkways, etc. Suitable for ramps covered in concrete, interlocking brick or asphalt, both for light and heavy traffic. The cable can be installed on ramps under construction, securing the electrowelded mesh prior to pouring of the concrete, or else on already completed ramps by cutting the concrete surfaces to then fill with plastic cement after installation of the cable, or simply by laying the cable on the surface of the ramp and throwing another layer of cement.

### Cable roofing cement or interlocking, asphalt, gneiss, and any other material

Product	Power at 0°C in concrete (W/m)	Max working temperature (°C)	Cable length	
			Switgear*	Maximum length (m)
MCA 20-I-GF	90	120	40 A	64
MCA 10**	50	65	40 A	90

\* Differential protection 30 mA

\*\*For ramps, stairs etc. with ambient temperature not lower than -15°C; for lower temperatures use only MCA 20-I-GF cable. For draining trenches tracing MCA8 cable shall be used. For other information contact Raytech.

Note: to trace drain outlets, use the MCA8 cable installed on the bottom of the outlets under the grate.

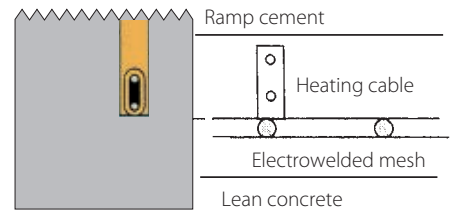

## MCA Ramp connection accessories

Connection kit integrated with the terminal box	Termination Kit	Joint Kit	Cable gland
MCA Universal IP68	MCA Universal IP68	MCA Universal IP68	MCA-PRESS



## Control unit for Easy Ramp and MCA Ramp

The C 2000 control unit, to be completed with the C2000-SR temperature, snow and humidity sensor (sensor to be placed flush with the ramp and to be ordered separately from the control unit), activating the power contactor, gives consent to start the system only when low temperature and snow or ice are present simultaneously, optimising energy consumption.

Control unit	Temperature, snow and humidity sensor
C2000	C2000-SR



For other accessories see page 226.



## Tracing systems **ANTI-FREEZE FOR GUTTERS**

Contact and self-regulating power cables to prevent the formation of ice and snow accumulation in gutters, downspouts and roof pitches.

### Easy Frost

**Constant power heating** cable for roofs, gutters and downpipes.

- Power:** 20 W/m
- Power supply:** 230 V ~ 50/60 Hz
- Heating cable dimensions:** ~ 5 x 7 mm
- Min. installation temperature:** + 5°C
- Max. working temperature:** + 80°C
- Cold cable (power supply):**  
length 4 meters - 3 x 1,0 mm<sup>2</sup>  
or 3 x 1,5 mm<sup>2</sup>
- Heating cable type:**  
2 conductors, screened cable
- Insulation:** XLPE
- External sheath:** PVC
- Min. bending radius:** 3,5 D
- Marking:** CE

Raytech Easy Frost is a 20 W/m constant power cable especially designed for roofs, gutters and downpipe protection from damage due to snow accumulation and ice formation. Easy Frost is supplied terminated and ready for installation, with 4 metres of cold cable (3 x 1,0 mm<sup>2</sup> o 3 x 1,5 mm<sup>2</sup>) for supply connection.

Product	Power (W)	Specific power (W/m)	Resistance (Ω)	Length (m)
Easy Frost 50/20	1000	20	52,9	50
Easy Frost 102/20	2040	20	29,9	102



Note: control unit C2000 works only when connected to both the C2000-SUG and C2000-STG sensors.

### Control unit for MCA 8 and Easy Frost

ON/OFF type control unit C 2000 to activate the power switch, to be completed with C 2000-STG temperature detection sensor and C 2000-SUG wet surfaces sensor: activates the system only when low temperature and water, ice or snow is present. (C 2000-STG and C 2000-SUG sensors are to be ordered and purchased separately from the control unit).

Control unit	Temperature sensor	Ice and snow sensor
C2000	C2000-STG	C2000-SUG

For other accessories see page 226.

# MCA 8

**Self-regulating** cable for tracing roofs, gutters and/or downpipes.

**Prevents**

The formation of ice inside gutters and downspouts, snow accumulation and ice on roofs, the development of infiltrations along façades, the development of ice sticks along gutters and roof ends.

**Avoiding**

Gutter breaking under the weight of snow, bursting and fracturing of drainpipes due to water freezing, damaged caused by a lack of draining caused by drain clogging, damage to persons or property caused by falling ice sticks, damage to persons or property caused by possible snow slides off rooves from roof edges.

Product	In air 0°C Power (W/m)	In chilly water Power (W/m)	Maximum cable length with starting temperature of -10°C through a switchgear (*) of		
			16 A	20 A	30 A
MCA8	24	40	40 m	50 m	90 m

\*Switchgear with "C" characteristic, having a differential protection of 30 mA

Note: the gutter cable is suspended along the down side of the drain pipes with accessory MCA-SUP. The cable is self-supporting up to 25 m vertical sections; in addition, an extra MCA-SUP accessory is provided for every 25 m, to which the cable is secured.

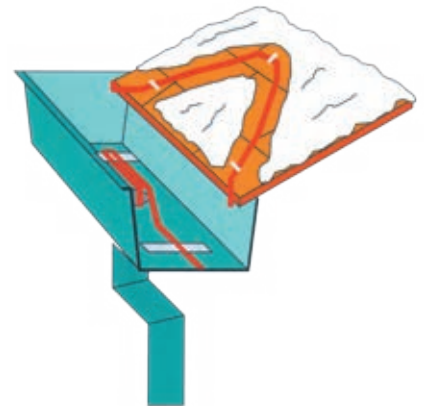

The image shows gutter installation, the input of cable in a downpipe and tracking of a roof pitch.

## MCA 8 connection accessories

Connection kit integrated with the terminal box	Termination Kit	Joint Kit
MCA Universal IP68	MCA Universal IP68	MCA Universal IP68
Branch Kit	Support device	
MCA Universal	MCA-SUP	

For other accessories see page 226.











# INDUSTRIAL USE

Anti-freeze maintenance  
and heating  
**up to 65°C continuous**  
**85°C intermittent**

**ATEX**



MCA3

MCA5

MCA7-I-PF

MCA8

MCA10

MCA13-I

Anti-freeze maintenance  
and heating  
**up to 120°C continuous**  
**120°C intermittent**



MCA3-I-GF

MCA5-I-GF

MCA8-I-GF

MCA10-I-GF

MCA20-I-GF

Anti-freeze maintenance,  
heating and washing  
**up to 120°C continuous**  
**190°C intermittent**

**ATEX**



MCA3-I-FF

MCA5-I-FF

MCA7-I-FF

MCA8-I-FF

MCA10-I-FF

MCA15-I-FF

MCA20-I-FF



**ATEX**

# MCA

**Self-regulating** heating cables for anti-freeze or temperature maintenance use with exposure to **mild inorganic solutions.**

Suitable for anti-freeze and process temperature maintenance use **up to 65°C** on piping and tanks. Cannot be used when washing with steam or continuous exposure to strong corrosive and organic acids.

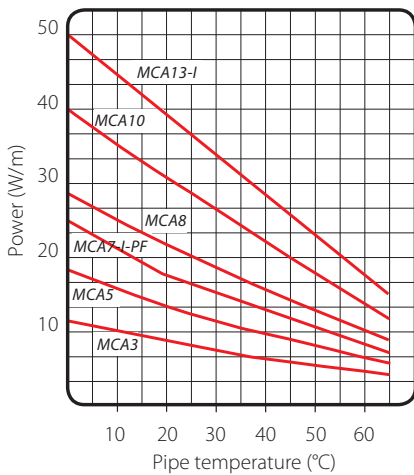

**CONSTITUTION OF THE CABLE**

- Copper conductors
- Self regulating conductive core
- Modified polyolefine insulation
- Copper screen
- Modified polyolefine or fluoropolymer (I-PF) outer sheath

**Cables certified for classified zones**

Ex II 2G Ex e IIC Gb  
Ex II 2D Ex tb IIIC Db  
In accordance:  
EN 60079-0 :2009  
EN 60079-31 :2009  
EN 60079-30-1 :2009

**Type of surface to be tracked:**

Steel - Painted - Stainless Steel - Plastic.

**Chemical resistance:** Suitable for exposure to mild inorganic solutions.

Product	Power voltage (V)	Power at 10°C (W/m)	Minimum installation temperature (°C)	MAX TEMPERATURE		Bending radius min. (mm)	Temperature classification EN50014
				Continuous cable powered (°C)	Intermittent cable not powered ≤1000 h cum. (°C)		
MCA3*	230	10	-45	65	80	25	T6
MCA5*	230	15	-45	65	80	25	T6
MCA7-I-PF	230	20	-45	65	80	25	T6
MCA8*	230	25	-45	65	80	25	T6
MCA10*	230	30	-45	65	80	25	T6
MCA13-I	230	40	-45	65	80	25	T6

Add the abbreviation **I-PF** for external fluoropolymer sheaths

**ELECTRICAL SIZING**

Starting temperature (°C)	Maximum length of the circuits in the heating cable (m)																	
	MCA3			MCA5			MCA7-I-PF			MCA8			MCA10			MCA13-I		
	+10°	-10°	-20°	+10°	-10°	-20°	+10°	-10°	-20°	+10°	-10°	-20°	+10°	-10°	-20°	+10°	-10°	-20°
10 A	-	-	-	103	71	62	-	-	-	64	47	37	49	38	33	-	-	-
16 A	177	144	125	160	114	99	109	79	70	103	75	60	78	61	53	57	44	40
20 A	-	149	139	-	133	124	129	99	87	126	94	75	97	76	66	71	55	50
25 A	-	-	-	-	-	-	-	111	104	-	107	94	112	95	83	89	69	62

\* Suggested where protection of people is requested; installations with no personnel admittance can be performed with 100 to 300 mA.

**MCA connection accessories**

Connection kit integrated with the terminal box	Termination Kit	Joint Kit	Branch Kit	Thermal insulation pass-through kit
MCA Universal IP68	MCA Universal IP68	MCA Universal IP68	MCA-Y	MCA-AL
Cable gland	Warning label	Fixing tape glass	Fixing tape Aluminum 25mm	Fixing tape Aluminum 75mm
MCA-PRESS	MCA-EA	MCA-FV	MCA-ALL25	MCA-ALL75

For other accessories see page 226.



# MCA-I-GF

**Self-regulating** heating cables for anti-freeze or temperature maintenance use with exposure to **corrosives and acids**.

Suitable for maintaining process temperatures **up to 120°C** on piping and tanks, even in the presence of acids and corrosives, or for anti-freeze use where acids and corrosives are present, in safe areas. Not suitable for use in the presence of steam washing.

#### CONSTITUTION OF THE CABLE

Copper conductors

Self regulating conductive core

Fluoropolymer insulation

Copper screen

Modified polyolefine outer sheath

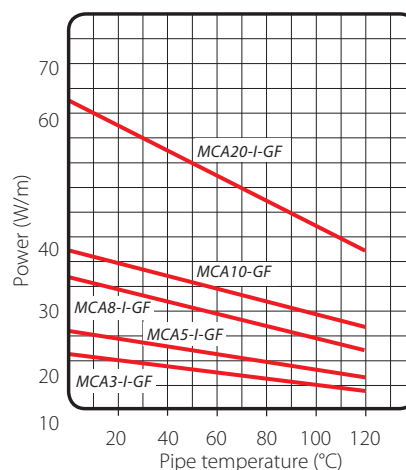

#### Type of surface to be tracked:

Steel - Painted - Stainless Steel.

**Chemical resistance:** Suitable for exposure to corrosive and organic acids.

Product	Power voltage (V)	Power at 10°C (W/m)	Minimum installation temperature (°C)	MAX TEMPERATURE		Bending radius min. (mm)	Temperature classification EN50014
				Continuous cable powered (°C)	Intermittent cable not powered ≤1000 h cum. (°C)		
MCA3-I-GF	230	10	-30	120	120	25	T3
MCA5-I-GF	230	15	-30	120	120	25	T3
MCA8-I-GF	230	25	-30	120	120	25	T3
MCA10-I-GF	230	30	-30	120	120	25	T3
MCA20-I-GF	230	60	-30	120	120	25	T3

#### ELECTRICAL SIZING

Maximum length of the circuits in the heating cable (m)

Starting temperature		MCA3-I-GF			MCA5-I-GF			MCA8-I-GF			MCA10-I-GF			MCA20-I-GF		
		+10°C	-15°C	-25°C	+10°C	-15°C	-25°C	+10°C	-15°C	-25°C	+10°C	-15°C	-25°C	+10°C	-15°C	-25°C
Switchgear protection (A), with C curve and 30mA* differential protection	16 A	200	180	175	165	130	117	120	97	88	85	73	69	50	41	38
	20 A	235	235	235	189	162	152	140	125	120	114	98	92	64	55	52
	30 A	-	-	-	-	-	189	-	-	140	-	-	114	-	-	64

\*Suggested where protection of people is requested; installations with no personnel admittance can be performed with 100 to 300 mA.

## Connection accessories for MCA-I-GF

Connection kit integrated with the terminal box	Termination Kit	Joint Kit	Branch Kit	Thermal insulation pass-through kit
MCA Universal IP68	MCA Universal IP68	MCA Universal IP68	MCA-Y	MCA-AL
Cable gland	Warning label	Fixing tape glass	Fixing tape Aluminum 25mm	Fixing tape Aluminum 75mm
MCA-PRESS	MCA-EA	MCA-FV	MCA-ALL25	MCA-ALL75

For other accessories see page 226.



**ATEX**

# MCA-I-FF

**Self-regulating** heating cables for anti-freeze or temperature maintenance use with exposure to **corrosives and acids and high temperatures.**

Suitable for maintaining process temperatures **up to 120°C** on piping and tanks, even in the presence of acids and corrosives, or for anti-freeze use even in the presence of acids and corrosives and where high temperature thermal treatment is foreseen, like steam washing, **up to 190°C.**

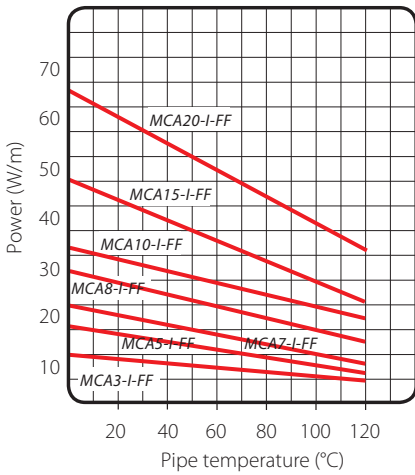

**CONSTITUTION OF THE CABLE**

- Copper conductors
- Self regulating conductive core
- Fluoropolymer insulation
- Copper screen
- Fluoropolymer outer sheath

**Cables certified for classified zones**

Ex II 2G Ex e IIC Gb  
Ex II 2D Ex tb IIIC Db  
In accordance:  
EN 60079-0 :2009  
EN 60079-31 :2009  
EN 60079-30-1 :2007

**Type of surface to be tracked:**  
Steel - Painted - Stainless Steel  
- Plastic.

**Chemical resistance:** Suitable for exposure to corrosive and organic acids.

Product	Power voltage (V)	Power at 10°C (W/m)	Minimum installation temperature (°C)	TEMPERATURE MAX		Bending radius min. (mm)	Temperature classification EN50014
				Continuous cable powered (°C)	Intermittente a cavo non alimentato ≤1000 h cum. (°C)		
MCA3-I-FF	230	10	-30	120	190	25	T3
MCA5-I-FF	230	15	-30	120	190	25	T3
MCA7-I-FF	230	20	-30	120	190	25	T3
MCA8-I-FF	230	25	-30	120	190	25	T3
MCA10-I-FF	230	30	-30	120	190	25	T3
MCA15-I-FF	230	45	-30	120	190	25	T3
MCA20-I-FF	230	60	-30	120	210	25	T3

**ELECTRICAL SIZING**

Maximum length of the circuits in the heating cable (m)

Starting temperature (°C)		MCA3-I-FF			MCA5-I-FF			MCA7-I-FF			MCA8-I-FF			MCA10-I-FF			MCA15-I-FF			MCA20-I-FF		
		+10°	-15°	-25°	+10°	-15°	-25°	+10°	-15°	-25°	+10°	-15°	-25°	+10°	-15°	-25°	+10°	-15°	-25°	+10°	-15°	-25°
Switchgear protection (A), with C curve and 30mA* differential protection	16 A	200	180	175	165	130	117	122	107	102	120	97	88	85	73	69	55	48	36	50	41	38
	20 A	235	235	235	189	162	152	136	127	124	140	125	120	114	98	92	68	60	57	64	55	52
	30 A	-	-	-	-	-	189	-	-	-	-	-	140	-	-	114	91	83	82	-	-	64

\* Suggested where protection of people is requested; installations with no personnel admittance can be performed with 100 to 300 mA.

**Connection accessories for MCA-I-FF**

Connection kit integrated with the terminal box	Termination Kit	Joint Kit	Branch Kit	Thermal insulation pass-through kit
MCA Universal IP68	MCA Universal IP68	MCA Universal IP68	MCA-Y	MCA-AL
Cable gland	Warning label	Fixing tape glass	Fixing tape Aluminum 25mm	Fixing tape Aluminum 75mm
MCA-PRESS	MCA-EA	MCA-FV	MCA-ALL25	MCA-ALL75

For other accessories see page 226.





# Accessories

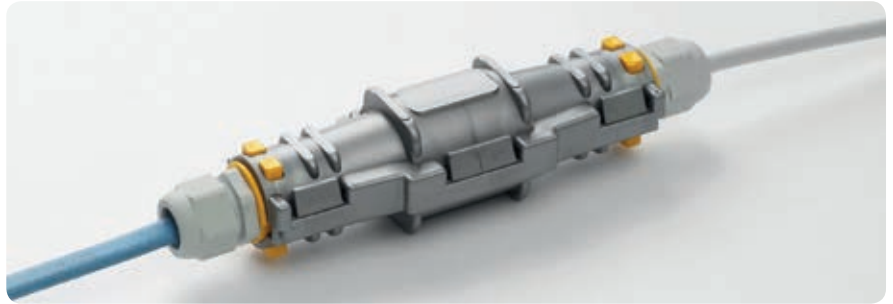

**Electrical:**  
EN 50393 and CEI 20-33  
(Note: with testing under water head  
and water between the cable cores),  
in Class 2

**Flame non propagation:**  
IEC 60332-1 and HD 405-1 (as applicable)

## MCA Universal IP68 and MCA-Y

Universal accessory for heating cable.

A revolutionary accessory is now available that is suitable for any type of self regulating heating cable either with or without screening. Its versatility provides a reliable unique solution unavailable elsewhere in the market. It has no shelf life and no tools are required during installation (including blow torches).

- Versatile and ready to use
- No need for tools
- Without heating
- Installable at any temperature
- Can be used directly underground
- Very compact
- Re-enterable
- Non toxic and flame retarded
- The connections are automatically blocked when the joint is closed
- Screw connectors available with the kit
- Also for underwater use
- Without shelf life

Product	Kit Composition	Dimension A x B x C (mm)
MCA Universal IP68	3 screw connectors to connect to the power cable or another heating cable	260 x 60 x 60
MCA-Y	3 screw connectors for branch connections between heating cables	150 x 30 x 56



Connection termination to the power cable



Pot end



Straight joint between Heating cables



Branch joint

## MCA-PC, MCA-PC-Compact

Connection kit.

Supply side termination allowing connections to a terminal box. Made of cold-shrink components and also a dedicated cable gland. One for each cable.



## MCA-PM, MCA-PM-Compact

Termination kit.

For insulating and matching the cable ends. Made from cold-shrink components. One kit for each termination.



## MCA-AL

Thermal insulation pass-through.

It allows the cable to pass through the metallic covering of the thermal insulation, avoiding abrasions and the moisture or water entry under the covering. It contains cable gland and fixing plate. One kit for each cable.



## MCA-GL

Joint kit.

To joint cable ends or to repair damaged cables. It contains all the components required, including connectors. One kit for each cable.

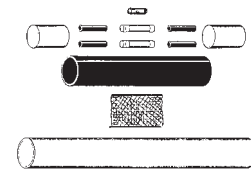

## MCA-PRESS

Cable gland.

To allow the cable to enter in boxes, to pass through walls etc. One kit per cable.



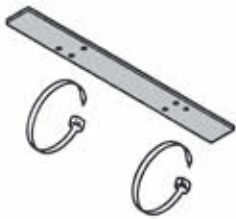

## MCA-SUP

Support device for gutters and down pipes.

It supports and fixes the cable in gutters and downpipes. In large gutters, requiring 2 cables laid longitudinally, it maintains the cable at the right distance.

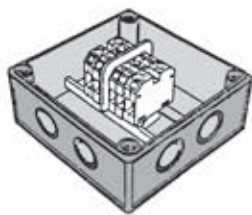

## MCA-SG

Box.

Box with IP55 degree of protection, complete of terminals. It allows the entry of 1 or more heating cables, or to branch a cable from a main tracing, or to joint cable lengths. Cables inside the box shall be MCA-PC terminated.



## MCA-FV

Glass fiber tape.

To fix the cable to the pipe, 3 turns every 0,3 m of pipe. Self adhesive, in 50 m rolls.



## MCA-ALL75

Aluminium self adhesive tape 75 mm width.

For cable fixing, in 50 m rolls.

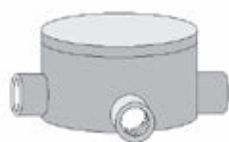

## GUAT 26

Connection kit for classified area.

WARNING  
ELECTRIC TRACING

## MCA-EA

Warning label.

To be applied for warning over traced items.



## Control Unit C2000

C 2000 Control unit for temperature and humidity.

The C2000 control unit and relative sensors are suitable for the tracing with both self-regulating cables and constant power cables. The unit allows you to power the system only when low temperatures and humid surfaces (snow - ice, etc.) are present simultaneously.

### Segnalling lamps

**ON** (green) voltage

**RELAY** (red) cable on power

**MOIST** (red) humidity presence

**TEMP** (red) the temperature is lower than the fixed

**Voltage:** 230V c.a. +/- 10% 50/60Hz

**Output:** N° 1 relays

**Switching capacity:** 16A (3600 W)

**Differential ON/OFF:** 0,4°C

**Temperature Range:** 0-10°C

**After run time:** 1-6 hours

**Protection degree:** IP20

**Dimensions:** 85 x 42 x 48,8 mm

**Weight:** 252 gr

**Room temperature:** 0/50°C



## C2000 - SR

Humidity and temperature sensor for ramps and stairs.

**Dimensions:** h 32 mm - Ø 60 mm

**Protection degree:** IP68

**Ambient temperature:** -20°C / +70°C

**Connecting cable:** 6x1,5 mm<sup>2</sup>, lenght. 10 m  
(possible increase up to 200 m)



## C2000 - SUG

Ice and snow sensor for gutters.

**Dimensions:** 105 x 30 x 10mm

**Protection degree:** IP68

**Ambient temperature:** -20°C / +70°C

**Connecting cable:** 4x1,5 mm<sup>2</sup>, lenght.10 m  
(possible increase up to 200 m)

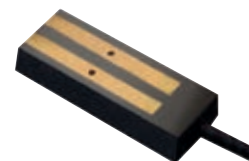

## C2000 - STG

Temperature sensor for gutters.

**Dimensions:** 86 x 45 x 35 mm

**Protection degree:** IP55

**Ambient temperature:** -20°C / 70°C

**Connecting cable:** not included











# COMFORT HOUSE

## Flooring

PRIMARY, SECONDARY OR FLOORING COMFORT HEATING SYSTEMS

page  
232



**Easy Floor**  
For the intelligent tracing of tile, marble, etc. floors



**Easy Wood**  
For the intelligent tracing of wood or laminate flooring



**Raytech Intelligent Display**  
Intelligent room timed thermostat

## Mirror

SELF-ADHESIVE HEATING SHEET

page  
236

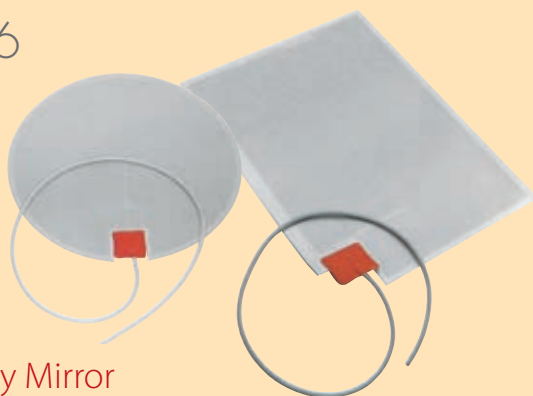

**Easy Mirror**

## Ceiling

CEILING HEATING PANELS

page  
237

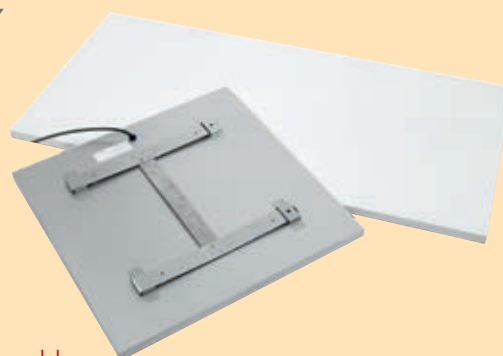

**Warm Up**

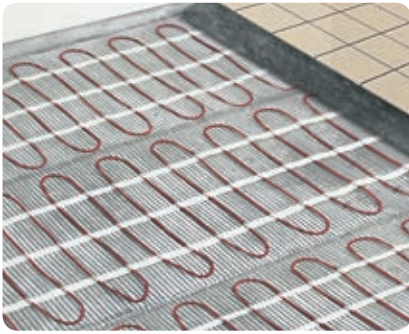

# Comfort House

Primary, secondary or flooring comfort heating systems.

Heating mats and intelligent timed thermostat: Raytech intelligent systems for primary, secondary and flooring heating comfort for homes, offices, kindergartens, schools and hospitals.

## Constant power heating mats for flooring

Combining the total reliability of the Raytech mat system with the RID microprocessor intelligent thermostat, it is possible to autonomously control all space heating parameters, as a primary means in less cold months and as a secondary means together with a more traditional system, and for comfort heating in bathrooms, kitchens, living rooms and children's bedrooms. After the first programming of the RID timed thermostat, you are free to forget about the system, which will run itself, ensuring optimal conditions.







# Easy Floor

Heating mat for the intelligent tracing of tile, marble, floors, etc.

The Easy Floor mat is laid directly on a layer of thermal insulation that coats the floor finished with concrete, and then buried in self-levelling concrete and covered with tiles. The flooring tracing mats are supplied in standard widths of 50 cm, power 150 W/m<sup>2</sup>.

Product	Width (m)	Length (m)	Power (W)
Easy Floor 2	0,5	2	150
Easy Floor 3	0,5	3	225
Easy Floor 4	0,5	4	300
Easy Floor 2-ST	0,5	2	150
Easy Floor 3-ST	0,5	3	225
Easy Floor 4-ST	0,5	4	300

Other sizes available upon request



The kit is composed of:

- Heating mat complete with cold tail
- RID microprocessor intelligent room timed thermostat complete with sensor
- Corrugated pipe for positioning

Note: -ST type kits are supplied without a RID room timed thermostat

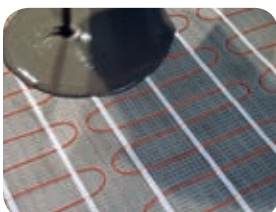



**The kit is composed of:**

Heating mat complete with connection wires and connectors, tapes and grippers for connection.

RID microprocessor intelligent room timed thermostat complete with sensor.

Corrugated pipe for sensor positioning

Note: provide for thermal insulation of at least 6 mm in thickness (e.g. sheet of polystyrene) under the heating sheet and a barrier against humidity (polythene sheet at least 0.1 mm) above.

Contact Raytech for any clarifications.

# Easy Wood

Heating mat for the intelligent tracing of wood or laminate floors.

Easy Wood is a very thin film (only 0.3 mm) controlled by a digital intelligent timed thermostat with RID microprocessor supplied with the kit. It is advisable not to exceed a temperature of 28°C. Suitable for secondary or comfort heating.

Product	Width (m)	Length (m)	Power (W)
Easy Wood 8	0,6	8,4	80
Easy Wood 16	0,6	16,8	80

Other sizes available upon request.

### Installation sequence

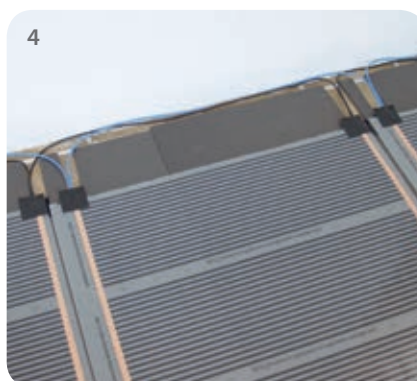
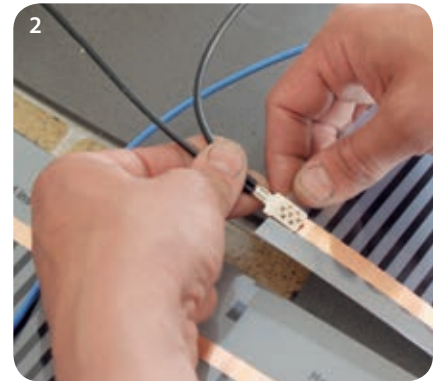





## Raytech Intelligent Display

Intelligent room timed thermostat.

The RID (Raytech Intelligent Display) microprocessor room timed thermostat is simple to use, thanks to its step-by-step programming guide. The easy to read display supplies a complete explanation of set parameters after 10 seconds.

It includes a wood floor function, which limits the temperature to 28°C for wood flooring.

The RID autonomously controls all room functions, with no need for extra operations. Weekly programming makes it possible to take into account the set temperature to be maintained, the type and thickness of the flooring, temperature limits not to be exceeded, modes for increasing temperature, etc.

This device is equipped with an anti-freeze function when the house is not inhabited, a block for untimely interventions (for example children) and communicates any operating failures to the appropriate alarms.



Sensor	Included with the kit
Temperature range	+5 / +50°C
Temperature limit	+5 / +55°C
Start Up Programme	Automatic, self learning
Manual	0,1-10°C
Room temperature	0 / +40°C
Differential On/Off	Standard 0,4°C Adjustable 0,1-1°C
Power supply	230 V / 50-60 Hz
Self-consumption	5 W
Max output current	16 A (3400 W/220 V)

Product	Dimensions (mm)
RID room thermostat	85 x 85 x 45

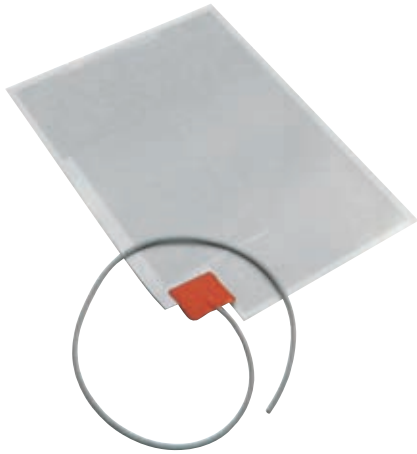

# Easy Mirror

Self-adhesive heating sheet.

No more fogged mirrors after a shower or bath! Easy Mirror, the self-adhering heating sheet to be applied on the back of the mirror and connected to the mains, eliminates this problem! Powered 230V, double insulated in accordance with safety regulations. Brings the surface of the mirror to 30°C in about 3-5 minutes, removing the film of moisture. Easy Mirror sheets are packaged with a sheet of laminated aluminium on polyester, with double insulation made with 4 more sheets of vulcanised polyester, completely sealed against water.

- Ideal for bathrooms, saunas, kitchens, private homes, Hotels, gyms and sports facilities

Product	Sheet dimensions (cm)	Power (W)
Easy Mirror 35	Ø 35	50
Easy Mirror 36/50	36 x 50	50

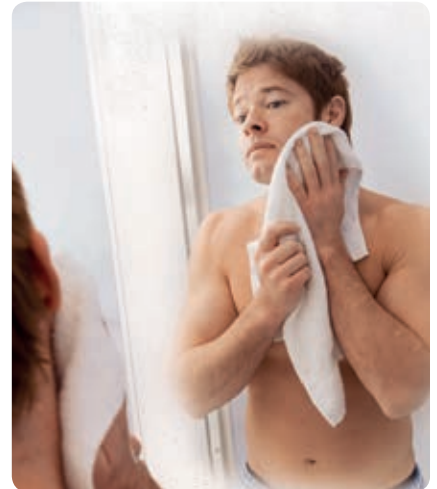

### Installation Sequence

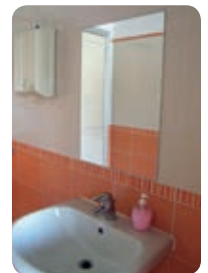
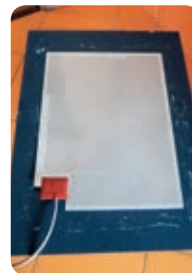





# warm up

Ceiling heating panels

Heat where you want it, when you want it



The ideal solution for all low thermal comfort environments





# Warm Up

Ceiling heating panels.

WARM-UP ceiling heating panels by Raytech can be installed invisibly and built into the ceiling of any home, office, showroom, workshop, greenhouse, camper vans etc., maximising space and freeing up wall space. Their positioning does not require any invasive procedures on the walls of the room, and their electrical connection is extremely simple. They can be installed, possibly placing them at the points where maximum thermal efficiency is required, with any mounting system: hung with chains, flush mounted, or recessed in false ceilings, always easily and quickly. The type of heating, based on infrared radiation, which makes it similar to solar radiation, is safe and unharmed, quick, efficient and extremely comfortable.

## Why choose the Warm-Up System?

- It is installed without requiring any invasive procedures to be carried out on the structures of the house.
- It is easily uninstalled for re-use in another context.
- Its radiated heat is safe, with no air movement, and does not dirty the walls and room.
- It is used for primary heating and for secondary heating as an integrative system, and optimises and reduces heating costs thanks to the RID-WL thermostat.

An ideally integrated invisible system that can also be decorative!



VERANDAS



PREFABRICATED BUILDINGS

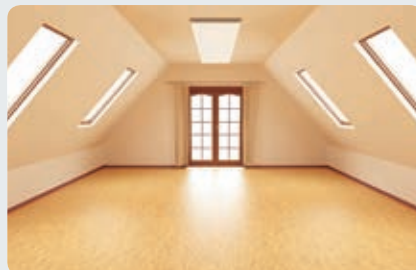

EXHIBITION SPACES



GAZEBOS

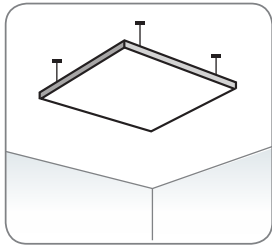

SUSPENDED

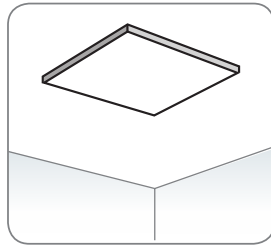
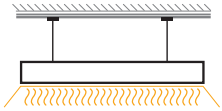

FIXED

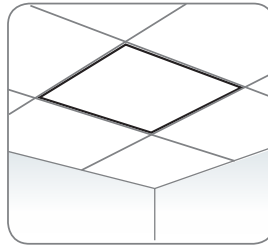
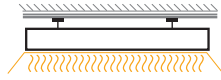

ENCASED

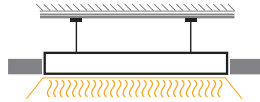

Controlled by a timed thermostat or a power regulator, they reduce consumption to a minimum

**Class 2**  
degree of protection IP44

**Power required for comfort heating:**  
about 60W/m<sup>2</sup>  
(one Warm Up 1 panel every 5m<sup>2</sup>)

**For primary heating with well-insulated walls:**  
about 120W/m<sup>2</sup>

## What Are the Benefits to the System compared to others?

- Heating is immediate, in just a few minutes.
- It leaves room walls free because it is installed on the ceiling, flush mounted or recessed in false ceilings.
- It does not pollute, as it does not use gas or hydrocarbons.
- It optimises heating and reduces costs.
- Unlike other types of heating systems, it does not require maintenance!
- It uses the energy produced by photovoltaic systems, reducing heating costs.
- It can be coloured, and is therefore easily camouflaged or used as a decorative element.



Product	Color	Power	Dimensions (mm)
Warm Up 1	White, Paintable	300 W	590 x 590 x 40
Warm Up 2		600 W	1190 x 590 x 40



STORES



OFFICES



WAREHOUSES - GARAGES



HOMES



## Warm Up accessories



**Temperature accuracy:** 0,1°C  
**Field of operation:** from 0°C to +40°C  
**Field of temperature:** from 5°C to +35°C  
**Power supply:** 2 AAA 1.5 V batteries  
**Degree of protection:** IP30  
**Frequency:** 868 MHz  
**Powered receiver:** 230 V, 50 Hz  
**Relay range:** 8 A  
**Range in distance:**  
 100 m outdoors, 30 m indoors

Programmable in 30 minute blocks  
 9 pre-installed programmes and  
 4 user-set programmes  
 "Self-learning" temperature control  
 Child lock  
 Low battery alarm  
 Unlimited programme memory  
 in the case of discharged batteries



**Degree of protection:** IP30  
**Frequency:** 868 MHz  
**Powered receiver:**  
 230 V, 50 Hz  
**Relay range:** 8 A  
**Range in distance:**  
 100 m outdoors, 30 m indoors

### RID-WL

Digital wireless timed thermostat.

Raytech has established the innovative WIRELESS RID-WL TIMED ROOM THERMOSTAT for maximum efficiency and speed and ease of installation. This system combines well-known reliability and control of environmental parameters of the system RID with a wireless connection.

The RID-WL, which operates in radio frequency, allows non-invasive installation in any environment, both for new installations and those related to renovations, or to reinforce an existing primary system.

The RID-WL is coupled with its own receiver, tuned to the frequency of its own thermostat (exclusive signal), which is able to control an ampacity of 8 A.

RID-WL, since it is not wired, it can be moved within the range of use and positioned where controlling the parameters is important.

It is equipped with an easy to read backlit LCD screen and is programmable and provided with a built-in internal sensor, but can be connected to a separate sensor, for example on the floor.

Product	Description
RID-WL	Timed thermostat including receiver

### Additional relay device

Additional relay device, with a maximum of 6 devices which can be controlled by the same RID-WL timed thermostat

Product	Description
RID-WL-R	Additional receiver for loads greater than 8 A



## Product Code Index

	Product	Code	Category	Page	
0-9	250 RTD-20/A	250RTD20/A	Separable connectors	198	
	250 RTD-20/B	250RTD20/B	Separable connectors	198	
	250 RTD-20/C	250RTD20/C	Separable connectors	198	
	250 RTD-20/D	250RTD20/D	Separable connectors	198	
	250 RTD-20/E	250RTD20/E	Separable connectors	198	
	250 RTD-20/F	250RTD20/F	Separable connectors	198	
	250 RTS-20/A	250RTS20/A	Separable connectors	198	
	250 RTS-20/B	250RTS20/B	Separable connectors	198	
	250 RTS-20/C	250RTS20/C	Separable connectors	198	
	250 RTS-20/D	250RTS20/D	Separable connectors	198	
	250 RTS-20/E	250RTS20/E	Separable connectors	198	
	250 RTS-20/F	250RTS20/F	Separable connectors	198	
	630 RTO-20/A-C400	630RTO20/A-C400	Separable connectors	199	
	630 RTO-20/B-C400	630RTO20/B-C400	Separable connectors	199	
	630 RTO-20/C-C630	630RTO20/C-C630	Separable connectors	199	
	630 RTO-20/D-C630	630RTO20/D-C630	Separable connectors	199	
	630 RTO-30/A-C400	630RTO30/A-C400	Separable connectors	199	
	630 RTO-30/B-C400	630RTO30/B-C400	Separable connectors	199	
	630 RTO-30/C-C630	630RTO30/C-C630	Separable connectors	199	
	630 RTO-30/D-C630	630RTO30/D-C630	Separable connectors	199	
	630 RTT-20/A-C95	630RTT20/A-C95	Separable connectors	199	
	630 RTT-20/B-C150	630RTT20/B-C150	Separable connectors	199	
	630 RTT-20/C-C240	630RTT20/C-C240	Separable connectors	199	
	630 RTT-20/D-C240	630RTT20/D-C240	Separable connectors	199	
	630 RTT-20/E-C300	630RTT20/E-C300	Separable connectors	199	
	630 RTT-30/A-C95	630RTT30/A-C95	Separable connectors	199	
	630 RTT-30/B-C150	630RTT30/B-C150	Separable connectors	199	
	630 RTT-30/C-C240	630RTT30/C-C240	Separable connectors	199	
	630 RTT-30/D-C240	630RTT30/D-C240	Separable connectors	199	
	630 RTT-30/E-C300	630RTT30/E-C300	Separable connectors	199	
	A	AUTO 10/120-E	10120-E-AUTO	Cold-shrink	173
		AUTO 10/120-I	10120-I-AUTO	Cold-shrink	172
		AUTO 10/240-E	10240-E-AUTO	Cold-shrink	173
		AUTO 10/240-I	10240-I-AUTO	Cold-shrink	172
		AUTO 10/300-E	10300-E-AUTO	Cold-shrink	173
		AUTO 10/630-E	10630-E-AUTO	Cold-shrink	173
		AUTO 10/630-I	10630-I-AUTO	Cold-shrink	172
		AUTO 15/240-E	15240-E-AUTO	Cold-shrink	173
		AUTO 15/240-I	15240-I-AUTO	Cold-shrink	172
		AUTO 15/300-E	15300-E-AUTO	Cold-shrink	173
		AUTO 15/630-E	15630-E-AUTO	Cold-shrink	173
		AUTO 15/630-I	15630-I-AUTO	Cold-shrink	172
		AUTO 15/70-E	1570-E-AUTO	Cold-shrink	173
		AUTO 15/70-I	1570-I-AUTO	Cold-shrink	172
		AUTO 20/185-E	20185-E-AUTO	Cold-shrink	173
		AUTO 20/185-E-3	20185-E-3-AUTO	Cold-shrink	175
		AUTO 20/185-E-3ARM	20185-E3ARM-AUTO	Cold-shrink	175
		AUTO 20/185-I	20185-I-AUTO	Cold-shrink	172
		AUTO 20/185-I-3	20185-I-3-AUTO	Cold-shrink	175
		AUTO 20/185-I-3ARM	20185-I3ARM-AUTO	Cold-shrink	175
		AUTO 20/240-E	20240-E-AUTO	Cold-shrink	173
		AUTO 20/50-E	2050-E-AUTO	Cold-shrink	173

	Product	Code	Category	Page
	AUTO 20/50-E-3	2050-E-3-AUTO	Cold-shrink	173
	AUTO 20/50-E-3ARM	2050-E-3ARM-AUTO	Cold-shrink	175
	AUTO 20/50-I	2050-I-AUTO	Cold-shrink	172
	AUTO 20/50-I-3	2050-I-3-AUTO	Cold-shrink	175
	AUTO 20/50-I-3ARM	2050-I-3ARM-AUTO	Cold-shrink	175
	AUTO 20/630-E	20630-E-AUTO	Cold-shrink	173
	AUTO 20/630-E-3	20630-E-3-AUTO	Cold-shrink	175
	AUTO 20/630-E-3ARM	20630-E3ARM-AUTO	Cold-shrink	175
	AUTO 20/630-I	20630-I-AUTO	Cold-shrink	172
	AUTO 20/630-I-3	20630-I-3-AUTO	Cold-shrink	175
	AUTO 20/630-I-3ARM	20630-I3ARM-AUTO	Cold-shrink	175
	AUTO 30/120-E	30120-E-AUTO	Cold-shrink	173
	AUTO 30/120-I	30120-I-AUTO	Cold-shrink	174
	AUTO 30/240-E-3	30240-E-3-AUTO	Cold-shrink	175
	AUTO 30/240-E-3ARM	30240-E3ARM-AUTO	Cold-shrink	175
	AUTO 30/240-I-3	30240-I-3-AUTO	Cold-shrink	175
	AUTO 30/240-I-3ARM	30240-I3ARM-AUTO	Cold-shrink	175
	AUTO 30/400-E	30400-E-AUTO	Cold-shrink	174
	AUTO 30/400-I	30400-I-AUTO	Cold-shrink	174
	AUTO 30/95-E	3095-E-AUTO	Cold-shrink	174
	AUTO 30/95-E-3	3095-E-3-AUTO	Cold-shrink	175
	AUTO 30/95-E-3ARM	3095-E-3ARM-AUTO	Cold-shrink	175
	AUTO 30/95-I	3095-I-AUTO	Cold-shrink	174
	AUTO 30/95-I-3	3095-I-3-AUTO	Cold-shrink	175
	AUTO 30/95-I-3ARM	3095-I-3ARM-AUTO	Cold-shrink	175
B	BAG GEL 200-R	BAGGEL200-R	Insulating fillers	95
	BAG GEL 200-T	BAGGEL200-T	Insulating fillers	95
	BAG GEL 400-R	BAGGEL400-R	Insulating fillers	95
	BAG GEL 400-T	BAGGEL400-T	Insulating fillers	95
	BAG-RTV 200-N	BAGRTV200-N	Problem solving kits	161
	BAG-RTV 200-R	BAGRTV200-R	Problem solving kits	161
	BAG-RTV 350-N	BAGRTV350-N	Problem solving kits	161
	BAG-RTV 350-R	BAGRTV350-R	Problem solving kits	161
	BARNEY	BARNEY	Junctions	29
	BARNEY MP	BARNEY-MP	Junctions	29
	BARNEY-N	BARNEY-N	Junctions	29
	BARNEY Y (cf 1 pc)	BARNEY-Y	Junctions	31
	BARNEY Y Black (cf 1 pc)	BARNEY-Y/N	Junctions	31
	BAR BLISTER	BAR	Junctions-accessories	18
	BAR PACK 9	BARP9	Junctions-accessories	18
	BBIT-25/10-A/U	5609274001	Heat-shrink	202
	BBIT-40/16-A/U	560931-000	Heat-shrink	202
	BBIT-65/25-A/U	5609364001	Heat-shrink	202
	BBIT-100/40-A/U	560981-000	Heat-shrink	202
	BBIT-150/60-A/U	560982-000	Heat-shrink	202
BBIT-175/80-A/U	426377-000	Heat-shrink	202	
BBT 100/40-A/U	BBT100/40-AU	Heat-shrink	200	
BBT 150/60-A/U	BBT150/60-AU	Heat-shrink	200	
BBT 40/16-A/U	BBT40/16-AU	Heat-shrink	200	
BBT 65/25-A/U	BBT65/25-AU	Heat-shrink	200	
BOB4 (cf 1 pc)	BOB	Junctions	33	
BOB4 Black (cf 1 pc)	BOB4-N	Junctions	33	

Product	Code	Category	Page
BOPA 3	BOPA3-TEC	Junctions	82
BOPA 3/2	BOPA3/2-TEC	Junctions	82
BOPA 4	BOPA4-TEC	Junctions	82
BOPA 4-T transition	784472-TEC	Junctions	82
BOPA 5	BOPA5-TEC	Junctions	82
BPM 120/50-A/U	BPM120/50-AU	Heat-shrink	201
BPM 15/6-A/U	BPM15/6-AU	Heat-shrink	201
BPM 30/12-A/U	BPM30/12-AU	Heat-shrink	201
BPM 50/20-A/U	BPM50/20-AU	Heat-shrink	201
BPM 75/30-A/U	BPM75/30-AU	Heat-shrink	201
BPTM-15/6-A/U	5904284002	Heat-shrink	202
BPTM-30/12-A/U	723955-000	Heat-shrink	202
BPTM-50/20-A/U	2246244002	Heat-shrink	202
BPTM-75/30-A/U	6129164002	Heat-shrink	202
BPTM-100/40-A/U	178238-000	Heat-shrink	202
BPTM-120/50-A/U	412147-000	Heat-shrink	202
BPTM-175/70-A/U	920423-000	Heat-shrink	202
BPTM-205/110-A/U	499685-000	Heat-shrink	202
BRAVO 1-6 (cf 1 pc)	BRAVO1-6	Junctions	27
BRAVO 3-6 (cf 1 pc)	BRAVO3-6	Junctions	27
<b>C</b> C 2000	200001-000	Heating cables	229
C 2000-SR	200009-000	Heating cables	229
C 2000-STG	200005-000	Heating cables	229
C 2000-SUG	200004-000	Heating cables	229
CGP-TEC-1.2/0.6-0 Black	5069794007	Heat-shrink	123
CGP-TEC-1.2/0.6-2 Red	5069674009	Heat-shrink	123
CGP-TEC-1.2/0.6-4 Yellow	5069674011	Heat-shrink	123
CGP-TEC-1.2/0.6-6 Blue	5069674010	Heat-shrink	123
CGP-TEC-1.2/0.6-9 White	5069914004	Heat-shrink	123
CGP-TEC-1.2/0.6-X Transparent	5069674008	Heat-shrink	123
CGP-TEC-1.6/0.8-0 Black	5069804009	Heat-shrink	123
CGP-TEC-1.6/0.8-2 Red	5068034005	Heat-shrink	123
CGP-TEC-1.6/0.8-4 Yellow	5068154005	Heat-shrink	123
CGP-TEC-1.6/0.8-6 Blue	5068274004	Heat-shrink	123
CGP-TEC-1.6/0.8-9 White	5069924005	Heat-shrink	123
CGP-TEC-1.6/0.8-X Transparent	5069684005	Heat-shrink	123
CGP-TEC-2.4/1.2-0 Black	5069814012	Heat-shrink	123
CGP-TEC-2.4/1.2-2 Red	5068044005	Heat-shrink	123
CGP-TEC-2.4/1.2-4 Yellow	5068164005	Heat-shrink	123
CGP-TEC-2.4/1.2-6 Blue	5068284006	Heat-shrink	123
CGP-TEC-2.4/1.2-9 White	5069934006	Heat-shrink	123
CGP-TEC-2.4/1.2-X Transparent	5069694007	Heat-shrink	123
CGP-TEC-3.2/1.6-0 Black	5069824023	Heat-shrink	123
CGP-TEC-3.2/1.6-2 Red	5068054008	Heat-shrink	123
CGP-TEC-3.2/1.6-4 Yellow	5068174005	Heat-shrink	123
CGP-TEC-3.2/1.6-6 Blue	5068294010	Heat-shrink	123
CGP-TEC-3.2/1.6-9 White	5069944006	Heat-shrink	123
CGP-TEC-3.2/1.6-X Transparent	5069704005	Heat-shrink	123
CGP-TEC-4.8/2.4-0 Black	5069834023	Heat-shrink	123
CGP-TEC-4.8/2.4-2 Red	5068064006	Heat-shrink	123
CGP-TEC-4.8/2.4-4 Yellow	5068184005	Heat-shrink	123
CGP-TEC-4.8/2.4-6 Blue	5068304007	Heat-shrink	123

Product	Code	Category	Page
CGP-TEC-4.8/2.4-9 White	5069954004	Heat-shrink	123
CGP-TEC-4.8/2.4-X Transparent	5069714007	Heat-shrink	123
CGP-TEC-6.4/3.2-0 Black	5069844021	Heat-shrink	123
CGP-TEC-6.4/3.2-2 Red	5068074011	Heat-shrink	123
CGP-TEC-6.4/3.2-4 Yellow	5068194012	Heat-shrink	123
CGP-TEC-6.4/3.2-6 Blue	5068314009	Heat-shrink	123
CGP-TEC-6.4/3.2-9 White	5069964007	Heat-shrink	123
CGP-TEC-6.4/3.2-X Transparent	5069724010	Heat-shrink	123
CGP-TEC-9.5/4.8-0 Black	5069854021	Heat-shrink	123
CGP-TEC-9.5/4.8-2 Red	5068084007	Heat-shrink	123
CGP-TEC-9.5/4.8-4 Yellow	5068204006	Heat-shrink	123
CGP-TEC-9.5/4.8-6 Blue	5068324006	Heat-shrink	123
CGP-TEC-9.5/4.8-9 White	5069974006	Heat-shrink	123
CGP-TEC-9.5/4.8-X Transparent	5069734006	Heat-shrink	123
CGP-TEC-12.7/6.4-0 Black	5069864018	Heat-shrink	123
CGP-TEC-12.7/6.4-2 Red	5068094006	Heat-shrink	123
CGP-TEC-12.7/6.4-4 Yellow	5068214005	Heat-shrink	123
CGP-TEC-12.7/6.4-6 Blue	5068334005	Heat-shrink	123
CGP-TEC-12.7/6.4-9 White	5069984005	Heat-shrink	123
CGP-TEC-12.7/6.4-X Transparent	5069744004	Heat-shrink	123
CGP-TEC-19/9.5-0 Black	5069874011	Heat-shrink	123
CGP-TEC-19/9.5-2 Red	5068104006	Heat-shrink	123
CGP-TEC-19/9.5-4 Yellow	5068224005	Heat-shrink	123
CGP-TEC-19/9.5-6 Blue	5068344005	Heat-shrink	123
CGP-TEC-19/9.5-9 White	5069944004	Heat-shrink	123
CGP-TEC-19/9.5-X Transparent	5069754005	Heat-shrink	123
CGP-TEC-25.4/12.7-0 Black	5069884015	Heat-shrink	123
CGP-TEC-25.4/12.7-2 Red	5068114005	Heat-shrink	123
CGP-TEC-25.4/12.7-4 Yellow	5068234005	Heat-shrink	123
CGP-TEC-25.4/12.7-6 Blue	5068354006	Heat-shrink	123
CGP-TEC-25.4/12.7-9 White	5068384005	Heat-shrink	123
CGP-TEC-25.4/12.7-X Transparent	5069764008	Heat-shrink	123
CGP-TEC-38/19-0 Black	5069894005	Heat-shrink	123
CGP-TEC-38/19-2 Red	5068124001	Heat-shrink	123
CGP-TEC-38/19-4 Yellow	5068244001	Heat-shrink	123
CGP-TEC-38/19-6 Blue	5068364001	Heat-shrink	123
CGP-TEC-38/19-9 White	5068004001	Heat-shrink	123
CGP-TEC-38/19-X Transparent	5068364005	Heat-shrink	123
CGP-TEC-51/26-0 Black	5069904003	Heat-shrink	123
CGP-TEC-51/26-2 Red	5068134001	Heat-shrink	123
CGP-TEC-51/26-4 Yellow	5068254001	Heat-shrink	123
CGP-TEC-51/26-6 Blue	5068374001	Heat-shrink	123
CGP-TEC-51/26-9 White	226598-TEC	Heat-shrink	123
CGP-TEC-51/26-X Transparent	5069784002	Heat-shrink	123
CGP-TEC-76/38-0 Black	5067104003	Heat-shrink	123
CGP-TEC-76/38-2 Red	5067104002	Heat-shrink	123
CGP-TEC-76/38-4 Yellow	5067144001	Heat-shrink	123
CGP-TEC-76/38-6 Blue	889754-TEC	Heat-shrink	123
CGP-TEC-76/38-9 White	230701-000	Heat-shrink	123
CGP-TEC-76/38-X Transparent	763800-TEC	Heat-shrink	123
CGP-TEC-102/51-0 Black	5067164001	Heat-shrink	123
CGP-TEC-102/51-2 Red	5067204002	Heat-shrink	123

Product	Code	Category	Page	Product	Code	Category	Page
CGP-TEC-102/51-4 Yellow	5067204001	Heat-shrink	123	FRED	FRED	Junctions	29
CGP-TEC-102/51-6 Blue	5068204003	Heat-shrink	123	FRED MP	FRED-MP	Junctions	29
CGP-TEC-102/51-9 White	254199-TEC	Heat-shrink	123	FRED-N	FRED-N	Junctions	29
CGP-TEC-102/51-X Transparent	5067214001	Heat-shrink	123	FRED Y (cf 1 pc)	FRED-Y	Junctions	31
CLIK 0 FIRE	214663-003	Junctions	49	FRED Y-N (cf 1 pc)	FRED-Y/N	Junctions	31
CLIK 1 FIRE	225449-001	Junctions	49	FRED/4	FRED/4	Junctions	29
CLIK 1-FIRE AER/DAP (2 pc.)	302008-000	Junctions	50	FRED/4-N	FRED/4-N	Junctions	29
CLIK 1-FIRE DOR/DOR (4 pc.)	302009-000	Junctions	50	FSB-11	FSB-11	Flame retardant	146
CLIK 2 FIRE	301096-001	Junctions	49	FSB-12	FSB-12	Flame retardant	146
CLIK 2000 FIRE	214663-004	Junctions	49	FSB-13	FSB-13	Flame retardant	146
CLIK 2001 FIRE	225448-002	Junctions	49	FSC 11	FSC-11	Flame retardant	147
CLIK 2002 FIRE	301096-005	Junctions	49	FSC 12	FSC-12	Flame retardant	147
CLIK 2003 FIRE	301097-006	Junctions	49	FSC 13	FSC-13	Flame retardant	147
CLIK 2-FIRE DOR/PALO	301009-000	Junctions	50	FSC 14	FSC-14	Flame retardant	147
CLIK 2-FIRE DOR/PALO FUSE	301010-000	Junctions	50	FSC-TPC-050	FSC-TPC-050	Flame retardant	149
CLIK 2-FIRE PREC/DAP	301008-000	Junctions	50	FSC-TPC-060	FSC-TPC-060	Flame retardant	149
CHRONOTHERMOSTAT	RID-WL	Heating cables	240	FSC-TPC-090	FSC-TPC-090	Flame retardant	149
<b>D</b> DCP-TEC- 3/1.5-45	5038104002	Heat-shrink	123	FSC-TPC-120	FSC-TPC-120	Flame retardant	149
DCP-TEC- 6/3-45	5038604008	Heat-shrink	123	FSCC 150	FSCC-150	Flame retardant	151
DCP-TEC- 10/5-45	5038814001	Heat-shrink	123	FSCF 250	FSCF-250	Flame retardant	150
DCP-TEC- 12/6-45	5038114002	Heat-shrink	123	FSCF 350	FSCF-350	Flame retardant	150
DCP-TEC- 19/9-45	5038494001	Heat-shrink	123	FSCI 150	FSCI-150	Flame retardant	150
DCP-TEC- 26/13-45	5038184001	Heat-shrink	123	FSCO T110	FSCO-T110	Flame retardant	151
DCP-TEC- 38/19-45	5673904001	Heat-shrink	123	FSCP 600	FSCP-600	Flame retardant	149
DINO (cf 1 pc)	DINO	Junctions	29	FSCP 1200	FSCP-1200	Flame retardant	149
DINO Black (cf 1 pc)	DINO-N	Junctions	29	FSF 700	FSF-700	Flame retardant	148
DJ 01	416127-000	Junctions	82	FSM 20	FSM-20	Flame retardant	149
DJ 02	396633-000	Junctions	82	FSP-11	FSP-11	Flame retardant	146
DJ 03	396634-000	Junctions	82	FSS 310	91000-010	Flame retardant	148
DJ 4016 - F/R	DJ4016FR	Junctions	83	FSS 10	FSS-10	Flame retardant	148
DJ 4016 - ARM-F/R	DJ4016-ARM-FR	Junctions	83	FSS-E-300	FSS-E-300	Flame retardant	148
<b>E</b> EASY CABLE 26/25	EASYCABLE2625	Heating cables	215	FSSE 01	FSSE01	Flame retardant	150
EASY CABLE 44/25	EASYCABLE4425	Heating cables	215	FSSE 02	FSSE02	Flame retardant	150
EASY CABLE 92/25	EASYCABLE9225	Heating cables	215	FST-E-25/32	FST-E-25/32	Flame retardant	147
EASY FLOOR 2	EASYFLOOR2	Heating cables	233	<b>G</b> GALACTIC SEPARATOR 16	GALACTIC-SEP16	Problem solving kits	159
EASY FLOOR 2-ST	EASYFLOOR2-ST	Heating cables	233	GALACTIC ANIMAL BARRIER	GALACTIC-ANIBAR	Problem solving kits	156
EASY FLOOR 3	EASYFLOOR3	Heating cables	233	GALACTIC CLEANER	GALACTIC-CLEANER	Problem solving kits	159
EASY FLOOR 3-ST	EASYFLOOR3-ST	Heating cables	233	GALACTIC MAMMUT SECURITY	GALACTIC-MAM	Problem solving kits	154
EASY FLOOR 4	EASYFLOOR4	Heating cables	233	GALACTIC NANO JOINT 4	GALACTIC-NANOJ4	Problem solving kits	158
EASY FLOOR 4-ST	EASYFLOOR4-ST	Heating cables	233	GALACTIC PROTECTION	GALACTIC-PROT	Problem solving kits	156
EASY FROST 102/20	EASYFROST10220	Heating cables	218	GALACTIC SEPARATOR 6	GALACTIC-SEP6	Problem solving kits	159
EASY FROST 50/20	EASYFROST5020	Heating cables	218	GALACTIC WATER STOP	GALAWATERSTOP	Problem solving kits	157
EASY MIRROR 35	EASYMIRROR35	Heating cables	236	GASKET KIT	RAYGASKIT	Problem solving kits	162
EASY MIRROR 36/50	EASYMIRROR36/50	Heating cables	236	GDL 92 A1	224578-TEC	Junctions	81
EASY RAMP 13/300	EASYRAMP13300	Heating cables	216	GDL 92 A2	945252-TEC	Junctions	81
EASY RAMP 21/300	EASYRAMP21300	Heating cables	216	GDL 92 A3	935251-000	Junctions	81
EASY RAMP 4/300	EASYRAMP4300	Heating cables	216	GDL 92 PA	210254-TEC	Junctions	81
EASY RAMP 7/300	EASYRAMP7300	Heating cables	216	GEHV 60/B	159874-TEC	Heat-shrink	197
EASY WOOD 8	EASYWOOD8	Heating cables	234	GEHV 60/C	125444-TEC	Heat-shrink	197
EASY WOOD 16	EASYWOOD16	Heating cables	234	GEHV 60/D	467932-000	Heat-shrink	197
<b>F</b> FOX BOX (cf 1 pc)	FOXBOX	Junctions	37	GEL COVER 4	GELCOVER4	Coprimammut	16
FOX BOX-N	FOXBOX-N	Junctions	37	GEL COVER 6	GELCOVER6	Coprimammut	16



Product	Code	Category	Page
GELGUM JOINT-L	GELGUMJ-L	Insulating fillers	104
GELGUM JOINT-Y	GELGUMJ-Y	Insulating fillers	104
GHVE 15/50-1	153003-000	Heat-shrink	190
GHVE 15/50-3	545116-000	Heat-shrink	191
GHVE 15/50-ARM	155000-001	Heat-shrink	191
GHVE 15/300-1	442803-000	Heat-shrink	190
GHVE 15/300-1-H5	GHVE15/300-1-H5	Heat-shrink	190
GHVE 15/300-3	251291-000	Heat-shrink	191
GHVE 15/300-ARM	153000-001	Heat-shrink	191
GHVE 15/50-1-H5	GHVE15/50-1-H5	Heat-shrink	190
GHVE 15/630-1	357174-000	Heat-shrink	190
GHVE 15/630-1-H5	GHVE15/630-1-H5	Heat-shrink	190
GHVE 15/630-3	GHVE15/630-3	Heat-shrink	191
GHVE 15/630-ARM	GHVE15/630-ARM	Heat-shrink	191
GHVE 20/150-1/U	478596-000	Heat-shrink	194
GHVE 20/150-1-IS	080799-TEC	Heat-shrink	193
GHVE 20/185-1/U	512605-000	Heat-shrink	194
GHVE 20/185-1X-H5	512610-000	Heat-shrink	194
GHVE 20/240-1	623051-000	Heat-shrink	190
GHVE 20/240-1-ARM	623052-000	Heat-shrink	190
GHVE 20/240-1-H5	GHVE20/240-1-H5	Heat-shrink	190
GHVE 20/240-1-IS	20GHIS-TEC	Heat-shrink	193
GHVE 20/240-1-T	GHVE20/240-1-T	Heat-shrink	192
GHVE 20/240-1-TE	GHVE20/240-1-TE	Heat-shrink	192
GHVE 20/240-1X-TE	GHVE20/240-1X-TE	Heat-shrink	192
GHVE 20/240-3	708732-000	Heat-shrink	191
GHVE 20/240-ARM	202400-001	Heat-shrink	191
GHVE 20/25-1-T	202500-000	Heat-shrink	192
GHVE 20/400-1-T	250499-000	Heat-shrink	192
GHVE 20/630-1	GHVE20/630-1	Heat-shrink	190
GHVE 20/630-1-ARM	GHVE20/630-1-ARM	Heat-shrink	190
GHVE 20/630-1-H5	GHVE20/630-1-H5	Heat-shrink	190
GHVE 20/630-3	GHVE20/630-3	Heat-shrink	191
GHVE 20/630-ARM	GHVE20/630-ARM	Heat-shrink	191
GHVE 30/240-1	GHVE30/240-1	Heat-shrink	190
GHVE 30/240-1-ARM	GHVE30/240-1-ARM	Heat-shrink	190
GHVE 30/240-1-H5	GHVE30/240-1-H5	Heat-shrink	190
GHVE 30/240-3	GHVE30/240-3	Heat-shrink	191
GHVE 30/240-ARM	GHVE30/240-ARM	Heat-shrink	191
GHVE 30/300-3	GHVE30/300-3	Heat-shrink	191
GHVE 30/300-ARM	GHVE30/300-ARM	Heat-shrink	191
GHVE 30/500-1	GHVE30/500-1	Heat-shrink	190
GHVE 30/500-1-ARM	GHVE30/500-1-ARM	Heat-shrink	190
GHVE 30/500-1-H5	GHVE30/500-1-H5	Heat-shrink	190
GHVP 20/150-1/U	085563-000	Heat-shrink	194
GHVP 20/240-1	GHVP20/240-1	Heat-shrink	190
GHVP 20/240-1/U	573299-000	Heat-shrink	194
GHVP 20/240-1-IS	159852-INT	Heat-shrink	193
GHVP 20/240-3	843918-000	Heat-shrink	191
GHVP 20/400-1	861101-000	Heat-shrink	190
GHVP 20/400-3	741685-000	Heat-shrink	191
GHVP 20/70-1	190901-000	Heat-shrink	190

Product	Code	Category	Page
GHVP 20/70-3	056242-000	Heat-shrink	191
GHVT 20/70-3X-1H	on request 1	Heat-shrink	193
GHVT 20/240-3X-1H	on request 2	Heat-shrink	193
GHVT 20/400-3X-1H	on request 3	Heat-shrink	193
GHVT-20/ 25-1X-3H	202020-000	Heat-shrink	193
GHVT-20/240-1X-3H	202019-000	Heat-shrink	193
GHVT-20/400-1X-3H	202021-000	Heat-shrink	193
GLV 0306	254656-TEC	Junctions	81
GLV 0306-N	788459-000	Junctions	81
GLV 0316	224477-TEC	Junctions	81
GLV 0316-N	788429-000	Junctions	81
GLV 0335	554268-TEC	Junctions	81
GLV 0335-N	788460-000	Junctions	81
GLV 0370	457896-TEC	Junctions	81
GLV 0370-N	788461-000	Junctions	81
GLV 0406	336598-TEC	Junctions	81
GLV 0406-ARM	788969-000	Junctions	82
GLV 0406-N	789995-000	Junctions	81
GLV 0416	789890-000	Junctions	81
GLV 0416 N	789996-000	Junctions	81
GLV 0416-ARM	307689-000	Junctions	82
GLV 0435	789891-000	Junctions	81
GLV 0435-N	789997-000	Junctions	81
GLV 0435-RP/16	GLV0435RP16	Junctions	79
GLV 0450-ARM	630855-000	Junctions	82
GLV 0470	234477-TEC	Junctions	81
GLV 0470 N	789998-000	Junctions	81
GLV 0470-RP/35	GLV0470RP35	Junctions	79
GLV 0470-RP/50	GLV0470RP50	Junctions	79
GLV 2.5-CP	411124-TEC	Junctions	81
GLV 3150	789992-000	Junctions	81
GLV 3150-N	788462-000	Junctions	81
GLV 3300	789994-000	Junctions	81
GLV 3300-N	210054-TEC	Junctions	81
GLV 4004-ARM-F/R	GLV4004-ARM-F/R	Junctions	83
GLV 4004-F/R	GLV4004-F/R	Junctions	83
GLV 4006-ARM-F/R-G7	GLV4006-ARM-F/R-G7	Junctions	83
GLV 4006-F/R-G7	GLV4006-F/R-G7	Junctions	83
GLV 4016-ARM-F/R	GLV4016-ARM-F/R	Junctions	83
GLV 4016-ARM-F/R-G7	GLV4016-ARM-F/R-G7	Junctions	83
GLV 4016-F/R	GLV4016-F/R	Junctions	83
GLV 4016-F/R-G7	GLV4016-F/R-G7	Junctions	83
GLV 4050-ARM-F/R	GLV4050-ARM-F/R	Junctions	83
GLV 4050-ARM-F/R-G7	GLV4050-ARM-F/R-G7	Junctions	83
GLV 4050-F/R	GLV4050-F/R	Junctions	83
GLV 4050-F/R-G7	GLV4050-F/R-G7	Junctions	83
GLV 4150	482979-000	Junctions	81
GLV 4150-ARM	378703-000	Junctions	72
GLV 4150-ARM-F/R	GLV4150-ARM-F/R	Junctions	83
GLV 4150-ARM-F/R-G7	GLV4150-ARM-F/R-G7	Junctions	83
GLV 4150-F/R	GLV4150-F/R	Junctions	83
GLV 4150-F/R-G7	GLV4150-F/R-G7	Junctions	83

Product	Code	Category	Page	Product	Code	Category	Page
GLV 4150-N	405718-000	Junctions	81	HVBT-14-A	475743-000	Heat-shrink	203
GLV 4150-RP/150	GLV4150RP150	Junctions	79	HVBT-16-A	215370-000	Heat-shrink	203
GLV 4300	609695-000	Junctions	81	ICE KILLER 2	ICEKILLER2	Heating cables	214
GLV 4300-ARM	152410-000	Junctions	82	ICE KILLER 6	ICEKILLER6	Heating cables	214
GLV 4300-N	788463-000	Junctions	81	ISAAC 4	ISAAC4	Junctions	15
GMC 004-A	802965-000	Junctions	84	ISAAC 4 MP	ISAAC4MP	Junctions	15
GMC 007-A	786769-000	Junctions	84	ISAAC 4 P30	ISAAC4P30	Junctions	15
GMC 010	939629-000	Junctions	84	IXSU-F-5121-IT01	200315-000	Heat-shrink	187
GMC 019-A	803162-000	Junctions	84	IXSU-F-5131-IT01	618429-000	Heat-shrink	187
GMC 020	786828-000	Junctions	84	IXSU-F-5131-IT02	364180-000	Heat-shrink	187
GMC 030	946619-000	Junctions	84	IXSU-F-5131-IT04	124400-TEC	Heat-shrink	187
GMC 037-A	786412-000	Junctions	84	IXSU-F-5151-IT01	897524-000	Heat-shrink	187
GMC 050	934676-000	Junctions	84	JMAUTO 20/95-1	JM-2095-1-AUTO	Cold-shrink	176
GMC 061-A	786355-000	Junctions	84	JMAUTO 20/240-1	JM-20240-1-AUTO	Cold-shrink	176
GMC 100	156732-000	Junctions	84	JMAUTO 20/400-1	JM-20400-1-AUTO	Cold-shrink	176
GMP 007	786768-000	Junctions	84	JMAUTO 30/95-1	JMAUTO 30/95-1	Cold-shrink	177
GMP 007-A	786686-000	Junctions	84	JMAUTO 30/185-1	JMAUTO 30/185-1	Cold-shrink	177
GMP 007-ARM-F/R	GMP007-ARM-F/R	Junctions	83	JOULE	JOULE	Junctions	16
GMP 007-F/R	GMP007-F/R	Junctions	83	JOULE MP Orange	JOULE-AMP	Junctions	16
GMP 014	666635-TEC	Junctions	84	JOULE MP Blue	JOULE-BMP	Junctions	16
GMP 014-A	786687-000	Junctions	84	JOULE MP Yellow	JOULE-GMP	Junctions	16
GMP 014-ARM-F/R	GMP014-ARM-F/R	Junctions	83	JOULE MP Black	JOULE-NMP	Junctions	16
GMP 014-F/R	GMP014-F/R	Junctions	83	JOULE MULTIPACK	JOULEMP	Junctions	16
GMP 014-ARM-F/R-G7	GMP014-ARM-F/R-G7	Junctions	83	J-BOX 100	JBOX100	Boxes	117
GMP 014-F/R-G7	GMP014-F/R-G7	Junctions	83	J-BOX 120	JBOX120	Boxes	117
GMP 019-ARM-F/R-G7	GMP019-ARM-F/R-G7	Junctions	83	J-BOX 150	JBOX150	Boxes	117
GMP 019-F/R-G7	GMP019-F/R-G7	Junctions	83	J-BOX 190	JBOX190	Boxes	117
GMP 021	786272-000	Junctions	84	J-BOX 240	JBOX240	Boxes	117
GMP 021-A	786785-000	Junctions	84	J-BOX 65	JBOX65	Boxes	117
GMP 030-ARM-F/R	GMP030-ARM-F/R	Junctions	83	J-BOX 80	JBOX80	Boxes	117
GMP 030-F/R	GMP030-F/R	Junctions	83	KELVIN	KELVIN	Junctions	16
GMP 040	786684-000	Junctions	84	KELVIN 6 pc +24 Mammut (4 mm <sup>2</sup> )	KELVINM4	Junctions	17
GMP 040-A	786356-000	Junctions	84	KELVIN MP	KELVINMP	Junctions	16
GMP 075	786683-000	Junctions	84	KELVIN PACK 9	KELVINP9	Junctions	16
GMP 075-A	786689-000	Junctions	84	KELVIN + 4	KELVIN+4	Junctions	17
GMP 100	786688-000	Junctions	84	KELVIN + 6	KELVIN+6	Junctions	17
GUAT 26	012452-000	Heating cables	228	KELVIN 6 pc +20 terminations (4 mm <sup>2</sup> )	KELVIN6+4	Junctions	17
H HAPPY 0	HAPPY0	Junctions	9	KELVIN 6 pc +20 terminations (6 mm <sup>2</sup> )	KELVIN6+6	Junctions	17
HAPPY 0 BOX 12	HAPPY0BOX12	Junctions	9	KING JOINT 0	RAYKJOINT0	Junctions	46
HAPPY 1	HAPPY1	Junctions	9	KING JOINT L10	RAYKJOINTL10	Junctions	46
HAPPY 1 BOX 10	HAPPY1BOX10	Junctions	9	KING JOINT L10-ARM	RAYKJL10ARM	Junctions	46
HAPPY 2	HAPPY2	Junctions	9	KING JOINT L25	RAYKJOINTL25	Junctions	46
HAPPY 2 BOX 7	HAPPY2BOX7	Junctions	9	KING JOINT L25-ARM	RAYKJL25ARM	Junctions	46
HAPPY JOINT 3	HAPPYJOINT3	Junctions	11	KING JOINT L6	RAYKJOINTL6	Junctions	46
HAPPY JOINT 36	HAPPYJOINT36	Junctions	13	KING JOINT Y 16	KINGJ-Y16	Junctions	47
HAPPY JOINT 4	HAPPYJOINT4	Junctions	11	KING JOINT Y 35	KINGJ-Y35	Junctions	47
HAPPY JOINT 46	HAPPYJOINT46	Junctions	13	KING JOINT Y 35-ARM	KINGJ-Y35ARM	Junctions	47
HAPPY JOINT 5	HAPPYJOINT5	Junctions	11	KING JOINT Y 6	KINGJ-Y6	Junctions	47
HAPPY JOINT 56	HAPPYJOINT56	Junctions	13	KING JOINT Y16-ARM	KINGJ-Y16ARM	Junctions	47
HAPPY JOINT 6	HAPPYJOINT6	Junctions	11	KING JOINT Y6-ARM	KINGJ-Y6ARM	Junctions	47
HVBT 15-A	736143-000	Heat-shrink	203	L LINUS insulation tape	LINUS	Heating cables	211
HVBT-12-A	364471-000	Heat-shrink	203	LST-TEC-1.6-0 Black (10 m)	6635996003	Heat-shrink	122

Product	Code	Category	Page
LST-TEC-1.6-6 Blue (10 m)	5068276019	Heat-shrink	122
LST-TEC-2.4-0 Black (10 m)	7284836003	Heat-shrink	122
LST-TEC-2.4-6 Blue (10 m)	5068286021	Heat-shrink	122
LST-TEC-3.2-0 Black (10 m)	0316676003	Heat-shrink	122
LST-TEC-3.2-6 Blue (10 m)	5068296023	Heat-shrink	122
LST-TEC-4.8-0 Black (9 m)	3876656003	Heat-shrink	122
LST-TEC-4.8-6 Blue (9 m)	5068306020	Heat-shrink	122
LST-TEC-6.4-0 Black (8 m)	3363736003	Heat-shrink	122
LST-TEC-6.4-6 Blue (8 m)	5068316033	Heat-shrink	122
LST-TEC-9.5-0 Black (6 m)	0915756003	Heat-shrink	122
LST-TEC-9.5-6 Blue (6 m)	5068326022	Heat-shrink	122
LST-TEC-12.7-0 Black (6 m)	1963796004	Heat-shrink	122
LST-TEC-12.7-6 Blue (6 m)	5068336020	Heat-shrink	122
LST-TEC-19.0-0 Black (5 m)	9601076004	Heat-shrink	122
LST-TEC-19.0-6 Blue (5 m)	5068346012	Heat-shrink	122
LST-TEC-25.4-0 Black (3 m)	2348536003	Heat-shrink	122
LST-TEC-25.4-6 Blue (3 m)	5068356017	Heat-shrink	122
LST-TEC-GV- 3/1.5 (7 m)	5038106035	Heat-shrink	122
LST-TEC-GV- 6/3 (5 m)	5038606049	Heat-shrink	122
LST-TEC-GV-10/5 (4 m)	5038816019	Heat-shrink	122
LST-TEC-GV-12/6 (7 m)	5038812764	Heat-shrink	122
LST-TEC-GV-19/9 (3 m)	5038496027	Heat-shrink	122
LST-TEC-GV-26/13 (2,5 m)	5038186026	Heat-shrink	122
LST-TEC-GV-4.8/2.4 (10 m)	5038815824	Heat-shrink	122
LTPSM 180/58-500	LTPSM180/58-500	Heat-shrink	128
LTPSM 245/80-500	LTPSM245/80-500	Heat-shrink	128
<b>M</b> MAGIC BOX 100	MAGICBOX100	KIT IP68	115
MAGIC BOX 120	MAGICBOX120	KIT IP68	115
MAGIC BOX 150	MAGICBOX150	KIT IP68	115
MAGIC BOX 190	MAGICBOX190	KIT IP68	115
MAGIC BOX 240	MAGICBOX240	KIT IP68	115
MAGIC BOX 65	MAGICBOX65	KIT IP68	115
MAGIC BOX 80	MAGICBOX80	KIT IP68	115
MAGIC FLUID 110	100110-MAG	Insulating fillers	93
MAGIC FLUID 170	100170-MAG	Insulating fillers	93
MAGIC FLUID 210	100210-MAG	Insulating fillers	93
MAGIC FLUID 420	100420-MAG	Insulating fillers	93
MAGIC FLUID 550	100550-MAG	Insulating fillers	93
MAGIC FLUID 90	100090-MAG	Insulating fillers	93
MAGIC GEL 300	MAGICGEL-300	Insulating fillers	93
MAGIC GEL 300 in blister	MAGICGEL-300-BL	Insulating fillers	93
MAGIC GEL 1000	MAGIC-GEL	Insulating fillers	93
MAGIC GEL 2000	MAGICGEL-2000	Insulating fillers	93
MAGIC GEL 10000	MAGICGEL10	Insulating fillers	93
MAGIC JOINT 4	100004-002	Junctions	58
MAGIC JOINT 4-FIRE	100004-FIRE	Junctions	60
MAGIC JOINT 10	100001-MAG	Junctions	58
MAGIC JOINT 10-FIRE	100010-FIRE	Junctions	60
MAGIC JOINT 25	100002-MAG	Junctions	58
MAGIC JOINT 25-FIRE	100006-FIRE	Junctions	60
MAGIC JOINT 35	100035-002	Junctions	58
MAGIC JOINT 35-FIRE	100035-FIRE	Junctions	60

Product	Code	Category	Page
MAGIC JOINT 50	100005-MAG	Junctions	58
MAGIC JOINT 50-FIRE	100050-FIRE	Junctions	60
MAGIC JOINT 95	100003-MAG	Junctions	58
MAGIC JOINT 95-FIRE	100095-FIRE	Junctions	60
MAGIC JOINT 120	100007-MAG	Junctions	58
MAGIC JOINT 120-FIRE	100120-FIRE	Junctions	60
MAGIC JOINT 240	100004-MAG	Junctions	58
MAGIC JOINT 240-FIRE	100240-FIRE	Junctions	60
MAGIC JOINT 300	100009-000	Junctions	58
MAGIC JOINT 300-FIRE	100300-FIRE	Junctions	60
MAGIC JOINT L120-RP/120	MAGICJL120RP120	Junctions	79
MAGIC JOINT L240-RP/150	MAGICJL240RP150	Junctions	79
MAGIC JOINT L35-RP/16	MAGICJL35RP16	Junctions	79
MAGIC JOINT L35-RP/35	MAGICJL35RP35	Junctions	79
MAGIC JOINT L50-RP/50	MAGICJL50RP50	Junctions	79
MAGIC JOINT S11-FIRE	100011-S11F	Junctions	61
MAGIC JOINT S12-FIRE	100012-S12F	Junctions	61
MAGIC JOINT S13-FIRE	100013-S13F	Junctions	61
MAGIC JOINT S14-FIRE	100014-S14F	Junctions	61
MAGIC JOINT S15-FIRE	100015-S15F	Junctions	61
MAGIC JOINT S16-FIRE	100016-S16F	Junctions	61
MAGIC JOINT S17-FIRE	100017-S17F	Junctions	61
MAGIC JOINT SP L16	MAGICJSP16	Junctions	74
MAGIC JOINT SP L25	MAGICJSP25	Junctions	74
MAGIC JOINT SP L6	MAGICJSP6	Junctions	74
MAGIC JOINT SP T35	MAGICJSP35	Junctions	74
MAGIC JOINT SP Y16	MAGICJSPY16	Junctions	74
MAGIC JOINT SP Y6	MAGICJSPY6	Junctions	74
MAGIC JOINT SY1-FIRE	100001-SY1F	Junctions	61
MAGIC JOINT SY2-FIRE	100002-SY2F	Junctions	61
MAGIC JOINT SY3-FIRE	100003-SY3F	Junctions	61
MAGIC JOINT T 16-FIRE	100005-T16F	Junctions	61
MAGIC JOINT T 25-FIRE	100006-T25F	Junctions	61
MAGIC JOINT T 35 FIRE	100007-T35F	Junctions	61
MAGIC JOINT T 40-FIRE	100008-T40F	Junctions	61
MAGIC JOINT T 64-FIRE	100009-T64F	Junctions	61
MAGIC JOINT T 500-FIRE	100010-T500F	Junctions	61
MAGIC JOINT T1000-FIRE	100011-T1000F	Junctions	61
MAGIC JOINT TS 16-FIRE	100005-TS16F	Junctions	61
MAGIC JOINT TS 25-FIRE	100006-TS25F	Junctions	61
MAGIC JOINT TS 35-FIRE	100007-TS35F	Junctions	61
MAGIC JOINT TS 40-FIRE	100008-TS40F	Junctions	61
MAGIC JOINT TS 64-FIRE	100009-TS64F	Junctions	61
MAGIC JOINT TS 500-FIRE	100010-TS500F	Junctions	61
MAGIC JOINT TS1000-FIRE	100011-TS1000F	Junctions	61
MAGIC JOINT Y 6	100006-MAG	Junctions	58
MAGIC JOINT Y 25	100025-MAG	Junctions	58
MAGIC JOINT Y 6-FIRE	100007-FIRE	Junctions	60
MAGIC JOINT Y 95	100095-MAG	Junctions	58
MAGIC JOINT Y240	100240-MAG	Junctions	58
MAGIC JOINT Y25-FIRE	100025-FIRE	Junctions	60
MAGIC JOINT Y95-FIRE	100096-FIRE	Junctions	60

Product	Code	Category	Page
MAGIC POWER GEL from 1 lt	MAGICPOWER-GEL	Insulating fillers	91
MAGIC POWER GEL 250	MAGICPOWER-250	Insulating fillers	91
MAGIC POWER GEL 500	MAGICPOWER-500	Insulating fillers	91
MAGIC POWER JOINT L10	MPOWERJOINT-L10	Junctions	52
MAGIC POWER JOINT L10-ARM	MPJOINTL10-ARM	Junctions	54
MAGIC POWER JOINT L10-S	MPOWERJOINT-L10S	Junctions	53
MAGIC POWER JOINT L120	MPOWERJOINT-L120	Junctions	52
MAGIC POWER JOINT L120-ARM	MPJOINTL120-ARM	Junctions	54
MAGIC POWER JOINT L120-RP/120	MPOWERJL120RP120	Junctions	78
MAGIC POWER JOINT L120-S	MPOWERJOINTL120S	Junctions	53
MAGIC POWER JOINT L240	MPOWERJOINT-L240	Junctions	52
MAGIC POWER JOINT L240-ARM	MPJOINTL240-ARM	Junctions	54
MAGIC POWER JOINT L240-RP/150	MPOWERJL240RP150	Junctions	78
MAGIC POWER JOINT L240-S	MPOWERJOINTL240S	Junctions	53
MAGIC POWER JOINT L25	MPOWERJOINT-L25	Junctions	52
MAGIC POWER JOINT L25-ARM	MPJOINTL25-ARM	Junctions	54
MAGIC POWER JOINT L25-S	MPOWERJOINT-L25S	Junctions	53
MAGIC POWER JOINT L300	MPOWERJOINT-L300	Junctions	52
MAGIC POWER JOINT L300-ARM	MPJOINTL300-ARM	Junctions	54
MAGIC POWER JOINT L300-S	MPOWERJOINTL300S	Junctions	53
MAGIC POWER JOINT L35	MPOWERJOINT-L35	Junctions	52
MAGIC POWER JOINT L35-ARM	MPJOINTL35-ARM	Junctions	54
MAGIC POWER JOINT L35-RP/16	MPOWERJL35RP16	Junctions	78
MAGIC POWER JOINT L35-RP/35	MPOWERJL35RP35	Junctions	78
MAGIC POWER JOINT L35-S	MPOWERJOINT-L35S	Junctions	53
MAGIC POWER JOINT L50	MPOWERJOINT-L50	Junctions	52
MAGIC POWER JOINT L50-ARM	MPJOINTL50-ARM	Junctions	54
MAGIC POWER JOINT L50-RP/50	MPOWERJL50RP50	Junctions	78
MAGIC POWER JOINT L50-S	MPOWERJOINT-L50S	Junctions	53
MAGIC POWER JOINT L95	MPOWERJOINT-L95	Junctions	52
MAGIC POWER JOINT SL11	MPOWERJOINTSL11	Junctions	55
MAGIC POWER JOINT SL12	MPOWERJOINTSL12	Junctions	55
MAGIC POWER JOINT SL13	MPOWERJOINTSL13	Junctions	55
MAGIC POWER JOINT SL14	MPOWERJOINTSL14	Junctions	55
MAGIC POWER JOINT SL15	MPOWERJOINTSL15	Junctions	55
MAGIC POWER JOINT SL16	MPOWERJOINTSL16	Junctions	55
MAGIC POWER JOINT SL17	MPOWERJOINTSL17	Junctions	55
MAGIC POWER JOINT SP L16	MPOWERJSPL16	Junctions	73
MAGIC POWER JOINT SP L25	MPOWERJSPL25	Junctions	73
MAGIC POWER JOINT SP L6	MPOWERJSPL6	Junctions	73
MAGIC POWER JOINT SP T35	MPOWERJSPT35	Junctions	73
MAGIC POWER JOINT SP Y16	MPOWERJSPY16	Junctions	73
MAGIC POWER JOINT SP Y6	MPOWERJSPY6	Junctions	73
MAGIC POWER JOINT SY1	MPOWERJOINTSY1	Junctions	55
MAGIC POWER JOINT SY2	MPOWERJOINTSY2	Junctions	55
MAGIC POWER JOINT SY3	MPOWERJOINTSY3	Junctions	55

Product	Code	Category	Page
MAGIC POWER JOINT SY4	MPOWERJOINTSY4	Junctions	55
MAGIC POWER JOINT T1000	MPOWERJOINTT1000	Junctions	55
MAGIC POWER JOINT T16	MPOWERJOINT-T16	Junctions	55
MAGIC POWER JOINT T25	MPOWERJOINT-T25	Junctions	55
MAGIC POWER JOINT T35	MPOWERJOINT-T35	Junctions	55
MAGIC POWER JOINT T40	MPOWERJOINT-T40	Junctions	55
MAGIC POWER JOINT T500	MPOWERJOINT-T500	Junctions	55
MAGIC POWER JOINT T64	MPOWERJOINT-T64	Junctions	55
MAGIC POWER JOINT TS1000	MPOWERJ-TS1000	Junctions	55
MAGIC POWER JOINT TS16	MPOWERJOINT-TS16	Junctions	55
MAGIC POWER JOINT TS25	MPOWERJOINT-TS25	Junctions	55
MAGIC POWER JOINT TS35	MPOWERJOINT-TS35	Junctions	55
MAGIC POWER JOINT TS40	MPOWERJOINT-TS40	Junctions	55
MAGIC POWER JOINT TS500	MPOWERJOINTTS500	Junctions	55
MAGIC POWER JOINT TS64	MPOWERJOINT-TS64	Junctions	55
MAGIC POWER JOINT Y240	MPOWERJOINT-Y240	Junctions	52
MAGIC POWER JOINT Y240-ARM	MPJOINTY240-ARM	Junctions	54
MAGIC POWER JOINT Y240-ARM-F	MPJOINTY240ARM-F	Junctions	54
MAGIC POWER JOINT Y240-S	MPOWERJOINTY240S	Junctions	53
MAGIC POWER JOINT Y25	MPOWERJOINT-Y25	Junctions	52
MAGIC POWER JOINT Y25-ARM	MPJOINTY25-ARM	Junctions	54
MAGIC POWER JOINT Y25- ARM-F	MPJOINTY25-ARM-F	Junctions	54
MAGIC POWER JOINT Y25-S	MPOWERJOINT-Y25S	Junctions	53
MAGIC POWER JOINT Y6	MPOWERJOINT-Y6	Junctions	52
MAGIC POWER JOINT Y6-ARM	MPJOINTY6-ARM	Junctions	54
MAGIC POWER JOINT Y6-ARM-F	MPJOINTY6-ARM-F	Junctions	54
MAGIC POWER JOINT Y6-S	MPOWERJOINT-Y6S	Junctions	53
MAGIC POWER JOINT Y95	MPOWERJOINT-Y95	Junctions	52
MAGIC POWER JOINT Y95-ARM	MPJOINTY95-ARM	Junctions	54
MAGIC POWER JOINT Y95-ARM-F	MPJOINTY95-ARM-F	Junctions	54
MAGIC POWER JOINT Y95-S	MPOWERJOINT-Y95S	Junctions	53
MAGIC RUBBER 10	MAGICRUBBER-10	Insulating fillers	106
MAGIC RUBBER 500	MAGIC-RUBBER	Insulating fillers	106
MAMMUT GEL COVER (8 pz)	MAMMUTGELCOVER	Coprimammut	18
MAMMUT GEL COVER 6 (6 pz)	MAMMUTGELCOVER6	Coprimammut	18
MAXI ROLL 1.6 Black (300 m)	MAXIROLL-1.6	Heat-shrink	123
MAXI ROLL 12.7 Black (150 m)	MAXIROLL-12.7	Heat-shrink	123
MAXI ROLL 19.0 Black (75 m)	MAXIROLL-19.0	Heat-shrink	123
MAXI ROLL 2.4 Black (300 m)	MAXIROLL-2.4	Heat-shrink	123
MAXI ROLL 25.4 Black (60 m)	MAXIROLL-25.4	Heat-shrink	123
MAXI ROLL 3.2 Black (300 m)	MAXIROLL-3.2	Heat-shrink	123
MAXI ROLL 4.8 Black (150 m)	MAXIROLL-4.8	Heat-shrink	123
MAXI ROLL 6.4 Black (75 m)	MAXIROLL-6.4	Heat-shrink	123
MAXI ROLL 9.5 Black (150 m)	MAXIROLL-9.5	Heat-shrink	123
MCA 3-I-FF	200134-000	Heating cables	224
MCA 3-I-GF	200131-000	Heating cables	223



Product	Code	Category	Page
MCA 5-I-FF	200135-000	Heating cables	224
MCA 5-I-GF	200132-000	Heating cables	223
MCA 7-I-FF	MCA7-I-FF	Heating cables	224
MCA 7-I-PF	MCA7-I-PF	Heating cables	222
MCA 10	220799-000	Heating cables	217
MCA 10-I-FF	200137-000	Heating cables	224
MCA 10-I-GF	261098-000	Heating cables	223
MCA 10-I-PF	261097-000	Heating cables	222
MCA 13-I	MCA13-I	Heating cables	222
MCA 15-I-FF	MCA15-I-FF	Heating cables	224
MCA 20-I-FF	200138-000	Heating cables	224
MCA 20-I-GF	320105-000	Heating cables	223
MCA 3 I-PF	200129-000	Heating cables	222
MCA 5 I-PF	261099-000	Heating cables	222
MCA 8 I-PF	200128-000	Heating cables	222
MCA 8 SMALL	MCA8-SMALL	Heating cables	224
MCA 8-I-FF	200136-000	Heating cables	224
MCA 8-I-GF	200133-000	Heating cables	223
MCA UNIVERSAL	MCA-UNIVERSAL	Heating cables	226
MCA2-COMPACT	MCA2COMPACT	Heating cables	213
MCA3	320102-000	Heating cables	212
MCA5	320103-000	Heating cables	212
MCA5-SMALL	MCA5-SMALL	Heating cables	212
MCA6-COMPACT	MCA6COMPACT	Heating cables	213
MCA8	320104-000	Heating cables	212
MCA-AL	RK16.02-00	Heating cables	227
MCA-ALL 75	R42562	Tapes	137
MCA-EA	014211-000	Heating cables	228
MCA-FV	012521-000	Tapes	228
MCA-GL	120021-TEC	Heating cables	227
MCA-PC	123110-TEC	Heating cables	227
MCA-PM	012511-000	Heating cables	227
MCA-PRESS	014144-000	Heating cables	227
MCA-SG	MCASG-TEC	Heating cables	228
MCA-SUP	RARAKE-000	Heating cables	228
MCA-UNIVERSAL IP68	MCA UNIVERSAL	Heating cables	226
MCA-Y	MCA-Y	Heating cables	226
MINI BRAVO 1	MINIBRAVO1	Junctions	27
MINI BRAVO 2	MINIBRAVO2	Junctions	27
MINI BRAVO 3	MINIBRAVO3	Junctions	27
MONOGEL	MONOGEL	Insulating fillers	101
MTN-10/3-1000/172	MTN1031000172	Heat-shrink	126
MTN-16/5-1000/172	MTN1651000172	Heat-shrink	126
MTN-25/8-1000/172	MTN2581000172	Heat-shrink	126
MTN-35/12-1000/172	MTN35121000172	Heat-shrink	126
MTN-50/16-1000/172	MTN50161000172	Heat-shrink	126
MTN-63/19-1000/172	MTN63191000172	Heat-shrink	126
MTN-75/22-1000/A172	MTN75221000172	Heat-shrink	126
MTN-85/25-1000/172	MTN85251000172	Heat-shrink	126
MTN-95/29-1000/172	MTN95291000172	Heat-shrink	126
MTN-115/34-1000/172	MTN115341000172	Heat-shrink	126
MTR-10/3-1000/U	854745-000	Heat-shrink	126

Product	Code	Category	Page
MTR-10/3-1000-172	488809-000	Heat-shrink	126
MTR-10/3-A/U-4	283807-000	Heat-shrink	126
MTR-115/34-1000/172	827835-000	Heat-shrink	126
MTR-115/34-1000/U	036893-000	Heat-shrink	126
MTR-140/42-1000/172	891939-000	Heat-shrink	126
MTR-140/42-1000/U	149759-000	Heat-shrink	126
MTR-16/5-1000/U	411365-000	Heat-shrink	126
MTR-16/5-1000-172	925679-000	Heat-shrink	126
MTR-16/5-A/U	497587-000	Heat-shrink	126
MTR-160/50-1000/U	938745-000	Heat-shrink	126
MTR-160/55-1000/172	474381-000	Heat-shrink	126
MTR-180/60-1000/172	323497-000	Heat-shrink	126
MTR-180/60-1000/U	827643-000	Heat-shrink	126
MTR-25/8-1000/U	082743-000	Heat-shrink	126
MTR-25/8-1000-172	717783-000	Heat-shrink	126
MTR-25/8-A/U-4	651145-000	Heat-shrink	126
MTR-35/12-1000/U	089407-000	Heat-shrink	126
MTR-35/12-1000-172	064641-000	Heat-shrink	126
MTR-35/12-A/U-4	981425-000	Heat-shrink	126
MTR-50/16-1000/U	738765-000	Heat-shrink	126
MTR-50/16-1000-172	046911-000	Heat-shrink	126
MTR-50/16-A/U-4	035001-000	Heat-shrink	126
MTR-63/19-1000/U	644113-000	Heat-shrink	126
MTR-63/19-1000-172	223993-000	Heat-shrink	126
MTR-63/19-A/U-4	874903-000	Heat-shrink	126
MTR-75/22-1000/172	237137-000	Heat-shrink	126
MTR-75/22-1000/U	605711-000	Heat-shrink	126
MTR-75/22-A/U-4	373921-000	Heat-shrink	126
MTR-85/25-1000/172	727282-000	Heat-shrink	126
MTR-85/25-1000/U	917867-000	Heat-shrink	126
MTR-95/29-1000/172	498559-000	Heat-shrink	126
MTR-95/29-1000/U	355919-000	Heat-shrink	126
<b>N</b> NANO 3 in blister (cf 4 pc)	NANO3	Junctions	21
NANO 5 in blister (cf 2 pc)	NANO5	Junctions	21
NANO 6 in blister (cf 1 pc)	NANO6	Junctions	21
NANO FOR-2.5 in blister (cf 1 pc)	NANOFOR-2.5	Junctions	23
NANO FOR-4 in blister (cf 1 pc)	NANOFOR-4	Junctions	23
NANO MAM-2.5 in blister (cf 2 pc)	NANOMAM-2.5	Junctions	23
NANO MAM-4 in blister (cf 1 pc)	NANOMAM-4	Junctions	23
<b>O</b> OHM BLISTER	OHM	Junctions-accessories	18
OHM PACK 11	OHMP11	Junctions-accessories	18
OXSU-F-5131-IT01	365890-000	Heat-shrink	187
OXSU-F-5131-IT02	123020-000	Heat-shrink	187
OXSU-F-5131-IT03	124500-TEC	Heat-shrink	187
<b>P</b> PASCAL 6	PASCAL6	Junctions	15
PASCAL 6 MP	PASCAL6MP	Junctions	15
PASCAL 6 P15	PASCAL6P15	Junctions	15
PASCAL 12+36 mammut 2,5 mm <sup>2</sup>	PASCALM2.5	Junctions	17
POWER KIT 100	POWER-100	KIT IP68	112
POWER KIT 120	POWER-120	KIT IP68	112
POWER KIT 65	POWER-65	KIT IP68	112
POWER KIT 80	POWER-80	KIT IP68	112

Product	Code	Category	Page
R RAPIDINO IP68 L2 (cf 3 pc)	RAPIDINOL2	Junctions	43
RAPIDINO IP68 L3 (cf 3 pc)	RAPIDINOL3	Junctions	43
RAPIDINO IP68 L4 (cf 1 pc)	RAPIDINOL4	Junctions	43
RAPIDINO IP68 Y1 (cf 2 pc)	RAPIDINOY1	Junctions	43
RAPIDINO IP68 Y3 (cf 1 pc)	RAPIDINOY3	Junctions	43
RAPID JOINT L 10	301098-004	Junctions	48
RAPID JOINT L 10-S	301098-035	Junctions	48
RAPID JOINT L 25	301098-006	Junctions	48
RAPID JOINT L 25-S	301098-036	Junctions	48
RAPID JOINT L 95	301098-003	Junctions	48
RAPID JOINT L 95-S	301098-012	Junctions	48
RAPID JOINT L1,5-IP68	RAPIDJL1.5-IP68	Junctions	41
RAPID JOINT L10 RP	RAPIDJL10RP	Junctions	78
RAPID JOINT L10-ARM	301098-10ARM	Junctions	48
RAPID JOINT L10-IP68	RAPIDJL10-IP68	Junctions	41
RAPID JOINT L10-RIP68/1	RAPDJL10-RIP68-1	Junctions	78
RAPID JOINT L10-RIP68/2	RAPDJL10-RIP68-2	Junctions	78
RAPID JOINT L10-RIP68/3	RAPDJL10-RIP68-3	Junctions	78
RAPID JOINT L10-RIP68/4	RAPDJL10-RIP68-4	Junctions	78
RAPID JOINT L25 RP	RAPIDJL25RP	Junctions	78
RAPID JOINT L25-ARM	301098-25ARM	Junctions	48
RAPID JOINT L25-IP68	RAPIDJL25-IP68	Junctions	41
RAPID JOINT L6	301098-037	Junctions	48
RAPID JOINT L6-IP68	RAPIDJL6-IP68	Junctions	41
RAPID JOINT L6-RIP68/1	RAPIDJL6-RIP68-1	Junctions	78
RAPID JOINT L6-RIP68/2	RAPIDJL6-RIP68-2	Junctions	78
RAPID JOINT L6-RIP68/3	RAPIDJL6-RIP68-3	Junctions	78
RAPID JOINT L6-RIP68/4	RAPIDJL6-RIP68-4	Junctions	78
RAPID JOINT L95 RP	RAPIDJL95RP	Junctions	78
RAPID JOINT L95-ARM	301098-016	Junctions	48
RAPID JOINT-LS1	301098-018	Junctions	48
RAPID JOINT-LS2	301098-019	Junctions	48
RAPID JOINT-LS3	301098-020	Junctions	48
RAPID JOINT-T 26	301098-021	Junctions	48
RAPID JOINT-T 61	301098-022	Junctions	48
RAPID JOINT-T101	301098-023	Junctions	48
RAPID JOINT-TS 26	301098-024	Junctions	48
RAPID JOINT-TS 61	301098-025	Junctions	48
RAPID JOINT-TS101	301098-026	Junctions	48
RAY CF 16	RAYCF16	Boxes-accessories	118
RAY CF 20	RAYCF20	Boxes-accessories	118
RAY CF 25	RAYCF25	Boxes-accessories	118
RAY CF 32	RAYCF32	Boxes-accessories	118
RAY CF 40	RAYCF40	Boxes-accessories	118
RAY CF 50	RAYCF50	Boxes-accessories	118
RAY COPPER 1000	COPPER-100	Tapes	136
RAY COPPER 2000	COPPER-200	Tapes	136
RAY COPPER 3000	COPPER-300	Tapes	136
RAY COPPER 5000	COPPER-500	Tapes	136
RAY COPPER 6000	COPPER-600	Tapes	136
RAY GEL 10 K-R	RAYGEL10K-R	Insulating fillers	95
RAY GEL 10 K-T	RAYGEL10K-T	Insulating fillers	95

Product	Code	Category	Page
RAY GEL 1000-R	RAYGEL1000-R	Insulating fillers	95
RAY GEL 1000-T	RAYGEL1000-T	Insulating fillers	95
RAY GEL 20 K-R	RAYGEL20K-R	Insulating fillers	95
RAY GEL 20 K-T	RAYGEL20K-T	Insulating fillers	95
RAY GEL 300	RAYGEL300R-BL	Insulating fillers	95
RAY GEL 300-R	RAYGEL300-R	Insulating fillers	95
RAY GEL 300-T	RAYGEL300-T	Insulating fillers	95
RAY PASS 16	RAYPASS16	Boxes-accessories	117
RAY PASS 21	RAYPASS21	Boxes-accessories	117
RAY PASS 29	RAYPASS29	Boxes-accessories	117
RAY PRESS-16	RAYPRESS16	Boxes-accessories	117
RAY PRESS-20	RAYPRESS20	Boxes-accessories	117
RAY PRESS-25	RAYPRESS25	Boxes-accessories	117
RAY PRESS-32	RAYPRESS32	Boxes-accessories	117
RAY PRESS-PG11	RAYPRESSPG11	Boxes-accessories	117
RAY PRESS-PG13.5	RAYPRESSPG13.5	Boxes-accessories	117
RAY PRESS-PG16	RAYPRESSPG16	Boxes-accessories	117
RAY PRESS-PG21	RAYPRESSPG21	Boxes-accessories	117
RAY RGC 16	RAYRGC16	Boxes-accessories	118
RAY RGC 20	RAYRGC20	Boxes-accessories	118
RAY RGC 25	RAYRGC25	Boxes-accessories	118
RAY RGC 32	RAYRGC32	Boxes-accessories	118
RAY RGC 40	RAYRGC40	Boxes-accessories	118
RAY RGC 50	RAYRGC50	Boxes-accessories	118
RAY ROLL 1.6 Black (20 m)	RAYROLL-1.6	Heat-shrink	122
RAY ROLL 12.7 Black (10 m)	RAYROLL-12.7	Heat-shrink	122
RAY ROLL 19.0 Black (5 m)	RAYROLL-19.0	Heat-shrink	122
RAY ROLL 2.4 Black (20 m)	RAYROLL-2.4	Heat-shrink	122
RAY ROLL 25 Black (5 m)	RAYROLL-25.4	Heat-shrink	122
RAY ROLL 3.2 Black (10 m)	RAYROLL-3.2	Heat-shrink	122
RAY ROLL 4.8 Black (10 m)	RAYROLL-4.8	Heat-shrink	122
RAY ROLL 6.4 Black (10 m)	RAYROLL-6.4	Heat-shrink	122
RAY ROLL 9.5 Black (10 m)	RAYROLL-9.5	Heat-shrink	122
Ray RTC 16	RAYRTC16	Boxes-accessories	118
Ray RTC 20	RAYRTC20	Boxes-accessories	118
Ray RTC 25	RAYRTC25	Boxes-accessories	118
Ray RTC 32	RAYRTC32	Boxes-accessories	118
Ray RTC 40	RAYRTC40	Boxes-accessories	118
Ray RTC 50	RAYRTC50	Boxes-accessories	118
RAYCAST D 6-S	100006-005	Junctions	65
RAYCAST D 25-S	100017-005	Junctions	65
RAYCAST D 6-ARM	100006-001	Junctions	66
RAYCAST D 6-ARM-F	100006-002	Junctions	66
RAYCAST D 95-S	100950-005	Junctions	65
RAYCAST D16/D25	100016-000	Junctions	65
RAYCAST D16-ARM	100016-001	Junctions	66
RAYCAST D16-ARM-F	100016-002	Junctions	66
RAYCAST D6	100006-000	Junctions	65
RAYCAST D95	100095-001	Junctions	65
RAYCAST D95-ARM	100095-004	Junctions	66
RAYCAST D95-ARM-F	100095-003	Junctions	66
RAYCAST DPS 6	100006-DPS	Junctions	67

Product	Code	Category	Page
RAYCAST DPS25	100025-DPS	Junctions	67
RAYCAST DPS95	100095-DPS	Junctions	67
RAYCAST L 10	100001-000	Junctions	64
RAYCAST L 10-ARM	100001-001	Junctions	66
RAYCAST L 10-S	100001-005	Junctions	65
RAYCAST L 16/L25	100002-000	Junctions	64
RAYCAST L 25-ARM	100002-002	Junctions	66
RAYCAST L 25-S	100025-005	Junctions	65
RAYCAST L 35	100035-001	Junctions	64
RAYCAST L 35-ARM	100035-ARM	Junctions	66
RAYCAST L 35-S	100035-005	Junctions	65
RAYCAST L 50	100500-000	Junctions	64
RAYCAST L 50-ARM	100003-001	Junctions	66
RAYCAST L 50-S	100050-005	Junctions	65
RAYCAST L 95	100095-000	Junctions	64
RAYCAST L120	100120-000	Junctions	64
RAYCAST L120-ARM	100120-002	Junctions	66
RAYCAST L120-RP/120	RAYCASTL120RP120	Junctions	79
RAYCAST L120-S	100120-005	Junctions	65
RAYCAST L240	100240-000	Junctions	64
RAYCAST L240-ARM	100240-LARM	Junctions	66
RAYCAST L240-RP/150	RAYCASTL240RP150	Junctions	79
RAYCAST L240-S	100240-055	Junctions	65
RAYCAST L35-RP/16	RAYCASTL35RP16	Junctions	79
RAYCAST L35-RP/35	RAYCASTL35RP35	Junctions	79
RAYCAST L50-RP/50	RAYCASTL50RP50	Junctions	79
RAYCAST LPS 10	100010-LPS	Junctions	66
RAYCAST LPS 25	100025-LPS	Junctions	66
RAYCAST LPS 95	100095-LPS	Junctions	66
RAYCAST LPS240	100240-LPS	Junctions	66
RAYCAST SD1	100001-OSD	Junctions	67
RAYCAST SD2	100002-OSD	Junctions	67
RAYCAST SD3	100003-OSD	Junctions	67
RAYCAST SL11	100011-OSL	Junctions	67
RAYCAST SL12	100012-OSL	Junctions	67
RAYCAST SL13	100013-OSL	Junctions	67
RAYCAST SL14	100014-OSL	Junctions	67
RAYCAST SL15	100015-OSL	Junctions	67
RAYCAST SL16	100016-OSL	Junctions	67
RAYCAST SP D16	RAYCASTSPD16	Junctions	75
RAYCAST SP D6	RAYCASTSPD6	Junctions	75
RAYCAST SP L16	RAYCASTSPL16	Junctions	75
RAYCAST SP L25	RAYCASTSPL25	Junctions	75
RAYCAST SP L6	RAYCASTSPL6	Junctions	75
RAYCAST SP T35	RAYCASTSPT35	Junctions	75
RAYCAST TL 16	100016-OTL	Junctions	67
RAYCAST TL 25	100025-OTL	Junctions	67
RAYCAST TL 35	100035-OTL	Junctions	67
RAYCAST TL 40	100040-OTL	Junctions	67
RAYCAST TL 64	100064-OTL	Junctions	67
RAYCAST TL500	100500-OTL	Junctions	67
RAYCAST TSL 16	100016-TSL	Junctions	67

Product	Code	Category	Page
RAYCAST TSL 25	100025-TSL	Junctions	67
RAYCAST TSL 35	100035-TSL	Junctions	67
RAYCAST TSL 40	100040-TSL	Junctions	67
RAYCAST TSL 64	100064-TSL	Junctions	67
RAYCAST TSL500	100500-TSL	Junctions	67
RAY-CSM- 12/3-1000/172	672693-000	Heat-shrink	127
RAY-CSM- 16/4-1000/172	542973-000	Heat-shrink	127
RAY-CSM- 24/6-1000/172	050119-000	Heat-shrink	127
RAY-CSM- 34/8-1000/172	453083-000	Heat-shrink	127
RAY-CSM- 48/12-1000/172	582237-000	Heat-shrink	127
RAY-CSM-110/30-1000/172	934589-000	Heat-shrink	127
RAY-CSM-130/36-1000/172	833598-000	Heat-shrink	127
RAY-CSM-160/50-1000/172	430277-000	Heat-shrink	127
RAY-CSM-180/50-1000/172	237977-000	Heat-shrink	127
RAY-CSM-56/16-1000/172	898079-000	Heat-shrink	127
RAY-CSM-70/21-1000/172	862223-000	Heat-shrink	127
RAY-CSM-90/25-1000/172	862225-000	Heat-shrink	127
Ray-fasc B 22/75 2,2x75	700000-049	Cable ties	164
Ray-fasc B 25/135 2,5x135	700000-003	Cable ties	164
Ray-fasc B 25/98 2,5x98	700000-002	Cable ties	164
Ray-fasc B 26/160 2,6x160	700000-004	Cable ties	164
Ray-fasc B 26/200 2,6x200	700000-005	Cable ties	164
Ray-fasc B 36/140 3,6x140	700000-006	Cable ties	164
Ray-fasc B 36/200 3,6x200	700000-007	Cable ties	164
Ray-fasc B 36/290 3,6x290	700000-008	Cable ties	164
Ray-fasc B 36/370 3,6x370	700000-009	Cable ties	164
Ray-fasc B 48/178 4,8x178	700000-011	Cable ties	164
Ray-fasc B 48/200 4,8x200	700000-012	Cable ties	164
Ray-fasc B 48/250 4,8x250	700000-013	Cable ties	164
Ray-fasc B 48/290 4,8x290	700000-014	Cable ties	164
Ray-fasc B 48/360 4,8x360	700000-015	Cable ties	164
Ray-fasc B 48/390 4,8x390	700000-016	Cable ties	164
Ray-fasc B 48/430 4,8x430	700000-017	Cable ties	164
Ray-fasc B 78/180 7,8x180	700000-052	Cable ties	164
Ray-fasc B 78/240 7,8x240	700000-019	Cable ties	164
Ray-fasc B 78/300 7,8x300	700000-020	Cable ties	164
Ray-fasc B 78/365 7,8x365	700000-021	Cable ties	164
Ray-fasc B 78/450 7,8x450	700000-022	Cable ties	164
Ray-fasc B 78/540 7,8x540	700000-023	Cable ties	164
Ray-fasc B 78/750 7,8x750	700000-024	Cable ties	164
Ray-fasc BBA 36	700002-000	Cable ties	165
Ray-fasc BBA 48	700004-000	Cable ties	165
Ray-fasc N 22/75 2,2x75	700000-050	Cable ties	164
Ray-fasc N 25/135 2,5x135	700000-027	Cable ties	164
Ray-fasc N 25/98 2,5x98	700000-026	Cable ties	164
Ray-fasc N 26/160 2,6x160	700000-028	Cable ties	164
Ray-fasc N 26/200 2,6x200	700000-029	Cable ties	164
Ray-fasc N 36/140 3,6x140	700000-030	Cable ties	164
Ray-fasc N 36x200 3,6x200	700000-031	Cable ties	164
Ray-fasc N 36x290 3,6x290	700000-032	Cable ties	164
Ray-fasc N 36x370 3,6x370	700000-033	Cable ties	164
Ray-fasc N 48/178 4,8x178	700000-035	Cable ties	164

Product	Code	Category	Page
Ray-fasc N 48x200 4,8x200	700000-036	Cable ties	164
Ray-fasc N 48x250 4,8x250	700000-037	Cable ties	164
Ray-fasc N 48x290 4,8x290	700000-038	Cable ties	164
Ray-fasc N 48x360 4,8x360	700000-039	Cable ties	164
Ray-fasc N 48x390 4,8x390	700000-040	Cable ties	164
Ray-fasc N 48x430 4,8x430	700000-041	Cable ties	164
Ray-fasc N 78/180 7,8x180	700000-051	Cable ties	164
Ray-fasc N 78/240 7,8x240	700000-043	Cable ties	164
Ray-fasc N 78/300 7,8x300	700000-044	Cable ties	164
Ray-fasc N 78/365 7,8x365	700000-045	Cable ties	164
Ray-fasc N 78/450 7,8x450	700000-046	Cable ties	164
Ray-fasc N 78/540 7,8x540	700000-047	Cable ties	164
Ray-fasc N 78/750 7,8x750	700000-048	Cable ties	164
Ray-fasc NBA 36	700003-000	Cable ties	165
Ray-fasc NBA 48	700005-000	Cable ties	165
Ray-fasc S	700001-000	Cable ties	165
Ray-fasc SI	700006-000	Cable ties	165
RAYK016	119983-000	Heat-shrink	129
RAYK026	017847-000	Heat-shrink	129
RAYK033	645763-000	Heat-shrink	129
RAYK046	747267-000	Heat-shrink	129
RAYK224	522347-000	Heat-shrink	129
RAYK333	324253-000	Heat-shrink	129
RAYK466	556514-001	Heat-shrink	129
RAYL011	334969-000	Heat-shrink	129
RAYL022	821617-000	Heat-shrink	129
RAYL033	692333-000	Heat-shrink	129
RAYL044	547889-000	Heat-shrink	129
RAYL048	068743-000	Heat-shrink	129
RAYL055	190805-000	Heat-shrink	129
RAYL066	855203-000	Heat-shrink	129
RAYRESIN 170	100170-000	Insulating fillers	107
RAYRESIN 210	100210-000	Insulating fillers	107
RAYRESIN 420	100420-000	Insulating fillers	107
RAYRESIN TAN 3,8	100380-TAN	Insulating fillers	107
RAY-RSM-34/10-1000/232	406345-000	Heat-shrink	127
RAY-RSM-34/10-1500/232	240699-000	Heat-shrink	127
RAY-RSM-53/13-1000/232	279727-000	Heat-shrink	127
RAY-RSM-53/13-1500/232	505955-000	Heat-shrink	127
RAY-RSM-84/20-1000/232	953639-000	Heat-shrink	127
RAY-RSM-84/20-1500/232	219483-000	Heat-shrink	127
RAY-RSM-107/29-1000/232	395359-000	Heat-shrink	127
RAY-RSM-107/29-1500/232	546145-000	Heat-shrink	127
RAY-RSM-143/36-1000/232	002611-000	Heat-shrink	127
RAY-RSM-143/36-1500/232	091525-000	Heat-shrink	127
RAY-RSM-198/55-1000/232	318575-000	Heat-shrink	127
RAY-RSM-198/55-1500/232	247637-000	Heat-shrink	127
RAY-RSM-250/98-1000/232	595947-000	Heat-shrink	127
RAY-RSM-250/98-1500/232	247698-000	Heat-shrink	127
RAY-RTV 1000-N	RAYRTV1000-N	Problem solving kits	161
RAY-RTV 1000-R	RAYRTV1000-R	Problem solving kits	161
RAY-RTV 10K-N	RAYRTV10K-N	Problem solving kits	161

Product	Code	Category	Page
RAY-RTV 10K-R	RAYRTV10K-R	Problem solving kits	161
RAY-RTV 20K-N	RAYRTV20K-N	Problem solving kits	161
RAY-RTV 20K-R	RAYRTV20K-R	Problem solving kits	161
RAY-RTV 400K-N	RAYRTV400K-N	Problem solving kits	161
RAY-RTV 400K-R	RAYRTV400K-R	Problem solving kits	161
RAYTEAM 1510 White	021514-004	Tapes	132
RAYTEAM 1510 Blue	021514-002	Tapes	132
RAYTEAM 1510 Yellow/Green	021514-003	Tapes	132
RAYTEAM 1510 Gray	021514-006	Tapes	132
RAYTEAM 1510 Brown	021514-007	Tapes	132
RAYTEAM 1510 Black	021514-000	Tapes	132
RAYTEAM 1510 Red	021514-001	Tapes	132
RAYTEAM 1510/13 White	021513-009	Tapes	132
RAYTEAM 1510/13 Blue	021513-006	Tapes	132
RAYTEAM 1510/13 Yellow	021513-004	Tapes	132
RAYTEAM 1510/13 Yellow/Green	021513-045	Tapes	132
RAYTEAM 1510/13 Gray	021513-008	Tapes	132
RAYTEAM 1510/13 Black	021513-000	Tapes	132
RAYTEAM 1510/13 Red	021513-002	Tapes	132
RAYTEAM 1510/13 Green	021513-005	Tapes	132
RAYTEAM 1525 White	270999-009	Tapes	132
RAYTEAM 1525 Blue	270999-006	Tapes	132
RAYTEAM 1525 Yellow	270999-004	Tapes	132
RAYTEAM 1525 Yellow/Green	270999-045	Tapes	132
RAYTEAM 1525 Gray	270999-008	Tapes	132
RAYTEAM 1525 Black	270999-000	Tapes	132
RAYTEAM 1525 Red	270999-002	Tapes	132
RAYTEAM 1525 Green	270999-005	Tapes	132
RAYTEAM 1925 White	012141-007	Tapes	132
RAYTEAM 1925 Blue	012141-002	Tapes	132
RAYTEAM 1925 Yellow/Green	012141-003	Tapes	132
RAYTEAM 1925 Gray	012141-004	Tapes	132
RAYTEAM 1925 Brown	012141-005	Tapes	132
RAYTEAM 1925 Black	012141-000	Tapes	132
RAYTEAM 1925 Red	012141-001	Tapes	132
RAYTEAM 1925/13 White	270913-005	Tapes	132
RAYTEAM 1925/13 Blue	270913-006	Tapes	132
RAYTEAM 1925/13 Yellow	270913-004	Tapes	132
RAYTEAM 1925/13 Yellow/Green	270913-045	Tapes	132
RAYTEAM 1925/13 Gray	270913-008	Tapes	132
RAYTEAM 1925/13 Brown	270913-001	Tapes	132
RAYTEAM 1925/13 Black	270913-000	Tapes	132
RAYTEAM 1925/13 Red	270913-002	Tapes	132
RAYTEAM 1925/13 Green	270913-050	Tapes	132
RAYTEAM 2525 White	280998-000	Tapes	132
RAYTEAM 2525 Gray	280997-000	Tapes	132
RAYTEAM 2525 Black	280999-000	Tapes	132
RAYTECH 2.3	3-2001-00-13	Tapes	134
RAYTECH 2-2 Black	3-3894-00-13	Tapes	135
RAYTECH 23 BT	3-2002-96-13	Tapes	134
RAYTECH 7-0	3-2042-00-13	Tapes	135
RAYTECH SUPER 3-3 Black	3-3061-00-13	Tapes	133



Product	Code	Category	Page
RAYTEFILL	3-2140-00-13	Tapes	135
RAY-TTF 1,5/16	RAY-TTF1,5/16	Junctions	79
RAY-TTF 10/35	RAY-TTF10/35	Junctions	79
RAY-TTF 25/50	RAY-TTF25/50	Junctions	79
RAY-TTF 35/150	RAY-TTF35/150	Junctions	79
RAY-TUM-12/3-0	5634732003	Heat-shrink	125
RAY-TUM-12/4-0	5509102048	Heat-shrink	125
RAY-TUM-16/4-0	8014642003	Heat-shrink	125
RAY-TUM-19/6-0	5067452035	Heat-shrink	125
RAY-TUM-24/6-0	4177512003	Heat-shrink	125
RAY-TUM-24/8-0	5509112040	Heat-shrink	125
RAY-TUM-3/1-0	5504062059	Heat-shrink	125
RAY-TUM-32/8-0	4951522003	Heat-shrink	125
RAY-TUM-4/1-0	550406260	Heat-shrink	125
RAY-TUM-40/13-0	5509122053	Heat-shrink	125
RAY-TUM-52/13-0	7024702003	Heat-shrink	125
RAY-TUM-6/2-0	5509092033	Heat-shrink	125
RAY-TUM-8/2-0	5110554007	Heat-shrink	125
RAY-TUM-9/3-0	5507832055	Heat-shrink	125
RAYW248	102022-TEC	Heat-shrink	129
RAYW516	519411-000	Heat-shrink	129
RAYW526	395067-000	Heat-shrink	129
RAYW533	443425-000	Heat-shrink	129
RDCT-B 3/1.5	315002-BAR	Heat-shrink	124
RDCT-B 6/3	630045-BAR	Heat-shrink	124
RDCT-B 10/5	105004-BAR	Heat-shrink	124
RDCT-B 12/6	126040-BAR	Heat-shrink	124
RDCT-B 19/9	199550-BAR	Heat-shrink	124
RDCT-B 26/13	261345-BAR	Heat-shrink	124
READY BOX IP68 90	READYBOX90	Junctions	35
READY BOX IP68 90/N	READYBOX90-N	Junctions	35
READY BOX IP68 120	READYBOX120	Junctions	35
READY BOX IP68 120/N	READYBOX120-N	Junctions	35
RGPO-B 2.4/1.2-0 Black	241200-BAR	Heat-shrink	124
RGPO-B 2.4/1.2-6 Blue	241206-BAR	Heat-shrink	124
RGPO-B 2.4/1.2-2 Red	241202-BAR	Heat-shrink	124
RGPO-B 3.2/1.6-0 Black	321600-BAR	Heat-shrink	124
RGPO-B 3.2/1.6-2 Red	321602-BAR	Heat-shrink	124
RGPO-B 3.2/1.6-6 Blue	321606-BAR	Heat-shrink	124
RGPO-B 3.2/1.6-9 White	321609-BAR	Heat-shrink	124
RGPO-B 3.2/1.6-X Transparent	321601-BAR	Heat-shrink	124
RGPO-B 4.8/2.4-0 Black	482400-BAR	Heat-shrink	124
RGPO-B 4.8/2.4-2 Red	482402-BAR	Heat-shrink	124
RGPO-B 4.8/2.4-6 Blue	482806-BAR	Heat-shrink	124
RGPO-B 4.8/2.4-9 White	482009-BAR	Heat-shrink	124
RGPO-B 4.8/2.4-X Transparent	482401-BAR	Heat-shrink	124
RGPO-B 6.4/3.2-0 Black	643200-BAR	Heat-shrink	124
RGPO-B 6.4/3.2-2 Red	643202-BAR	Heat-shrink	124
RGPO-B 6.4/3.2-6 Blue	643206-BAR	Heat-shrink	124
RGPO-B 6.4/3.2-X Transparent	643201-BAR	Heat-shrink	124
RGPO-B 9.5/4.8-0 Black	954800-BAR	Heat-shrink	124
RGPO-B 9.5/4.8-2 Red	954802-BAR	Heat-shrink	124

Product	Code	Category	Page
RGPO-B 9.5/4.8-6 Blue	954806-BAR	Heat-shrink	124
RGPO-B 9.5/4.8-X Transparent	954801-BAR	Heat-shrink	124
RGPO-B 12.7/6.4-0 Black	127640-BAR	Heat-shrink	124
RGPO-B 12.7/6.4-2 Red	127642-BAR	Heat-shrink	124
RGPO-B 12.7/6.4-6 Blue	127646-BAR	Heat-shrink	124
RGPO-B 12.7/6.4-X Transparent	127641-BAR	Heat-shrink	124
RGPO-B 19/9.5-0 Black	199500-BAR	Heat-shrink	124
RGPO-B 19/9.5-2 Red	199502-BAR	Heat-shrink	124
RGPO-B 19/9.5-6 Blue	199506-BAR	Heat-shrink	124
RGPO-B 19/9.5-X Transparent	199501-BAR	Heat-shrink	124
RGPO-B 25.4/12.7-0 Black	254120-BAR	Heat-shrink	124
RGPO-B 25.4/12.7-2 Red	254722-BAR	Heat-shrink	124
RGPO-B 25.4/12.7-6 Blue	254726-BAR	Heat-shrink	124
RGPO-B 25.4/12.7-X Transparent	254721-BAR	Heat-shrink	124
RGPO-B 38/19-0 Black	381900-BAR	Heat-shrink	124
RGPO-B 38/19-2 Red	381902-BAR	Heat-shrink	124
RGPO-B 38/19-6 Blue	381906-BAR	Heat-shrink	124
RGPO-B 38/19-X Transparent	381901-BAR	Heat-shrink	124
RGPO-B 51/26-0 Black	512600-BAR	Heat-shrink	124
RGPO-B-12.7/6.4-9 White	127649-BAR	Heat-shrink	124
RGPO-B-19/9.5-9 White	199509-BAR	Heat-shrink	124
RGPO-B-2.4/1.2-9 White	241209-BAR	Heat-shrink	124
RGPO-B-25.4/12.7-9 White	254129-BAR	Heat-shrink	124
RGPO-B-38/19-9 White	381909-BAR	Heat-shrink	124
RGPO-B-51/26-9 White	512609-BAR	Heat-shrink	124
RGPO-B-6.4/3.2-9 White	643209-BAR	Heat-shrink	124
RGPO-B-9.5/4.8-9 White	954809-BAR	Heat-shrink	124
RID-WL-R Additional relay device	RID-WL-R	Heating cables	240
RID Raytech Intelligent Display	RID	Heating cables	235
RUBBER FLUID 200	RUBBERFLUID-200	Insulating fillers	106
RUBBER FLUID 350	RUBBERFLUID350	Insulating fillers	106
RUBBER JOINT 4	RUBBERJOINT4	Junctions	63
RUBBER JOINT 10	RUBBERJOINT10	Junctions	63
RUBBER JOINT 25	RUBBERJOINT25	Junctions	63
RUBBER JOINT 35	RUBBERJOINT35	Junctions	63
RUBBER JOINT 50	RUBBERJOINT50	Junctions	63
RUBBER JOINT 95	RUBBERJOINT95	Junctions	63
RUBBER JOINT 120	RUBBERJOINT120	Junctions	63
RUBBER JOINT 240	RUBBERJOINT240	Junctions	63
RUBBER JOINT 300	RUBBERJOINT300	Junctions	63
RUBBER JOINT Y 6	RUBBERJOINTY6	Junctions	63
RUBBER JOINT Y 240	RUBBERJOINTY240	Junctions	63
RUBBER JOINT Y 25	RUBBERJOINTY25	Junctions	63
RUBBER JOINT Y 95	RUBBERJOINTY95	Junctions	63
<b>S</b> SHINY BRUSH SB4	SHINYBRUSCH4	Solar	163
SHINY SOLAR	SHINYSOLAR	Solar	163
SHINY SOLAR 1000	SHINYSOLAR-1000	Solar	163
SHINY SOLAR 5	SHINYSOLAR5	Solar	163
SKY PLAST	SKYPLAST	Insulating fillers	105
SKY PLAST 250	SKYPLAST250	Insulating fillers	105
SPEEDY AF	7139-0053	Cable pullers	143
SPEEDY AFS	7139-0055	Cable pullers	143

Product	Code	Category	Page
SPEEDY AS	7139-0054	Cable pullers	143
SPEEDY AT	7139-0048	Cable pullers	143
SPEEDY BU	7139-0045	Cable pullers	143
SPEEDY CA	7139-0049	Cable pullers	143
SPEEDY GLASS 3/10	7139-0035	Cable pullers	142
SPEEDY GLASS 3/15	7139-0036	Cable pullers	142
SPEEDY GLASS 3/20	7139-0037	Cable pullers	142
SPEEDY GLASS 3/25	7139-0060	Cable pullers	142
SPEEDY GLASS 3/30	7139-0038	Cable pullers	142
SPEEDY HELIX 4/10	7139-0031	Cable pullers	141
SPEEDY HELIX 4/15	7139-0032	Cable pullers	141
SPEEDY HELIX 4/20	7139-0033	Cable pullers	141
SPEEDY HELIX 4/30	7139-0034	Cable pullers	141
SPEEDY HELIX 5/10	7139-0025	Cable pullers	141
SPEEDY HELIX 5/15	7139-0026	Cable pullers	141
SPEEDY HELIX 5/20	7139-0027	Cable pullers	141
SPEEDY HELIX 5/25	7139-0064	Cable pullers	141
SPEEDY HELIX 5/30	7139-0028	Cable pullers	141
SPEEDY HELIX 5/50	7139-0029	Cable pullers	141
SPEEDY HELIX 5/60	7139-0030	Cable pullers	141
SPEEDY MO	7139-0072	Cable pullers	143
SPEEDY NYLON 3/10-F	SPEEDYNYLON3/10F	Cable pullers	139
SPEEDY NYLON 3/15-F	SPEEDYNYLON3/15F	Cable pullers	139
SPEEDY NYLON 3/20-F	SPEEDYNYLON3/20F	Cable pullers	139
SPEEDY NYLON 3/25-F	SPEEDYNYLON3/25F	Cable pullers	139
SPEEDY NYLON 3/5-F	SPEEDYNYLON3/5F	Cable pullers	139
SPEEDY NYLON 4/10-F	SPEEDYNYLON4/10F	Cable pullers	139
SPEEDY NYLON 4/15-F	SPEEDYNYLON4/15F	Cable pullers	139
SPEEDY NYLON 4/20-F	SPEEDYNYLON4/20F	Cable pullers	139
SPEEDY NYLON 4/25-F	SPEEDYNYLON4/25F	Cable pullers	139
SPEEDY NYLON 4/5-F	SPEEDYNYLON4/5F	Cable pullers	139
SPEEDY OL	7139-0071	Cable pullers	143
SPEEDY OTC	7139-0044	Cable pullers	143
SPEEDY OTL	7139-0047	Cable pullers	143
SPEEDY PN	7139-0050	Cable pullers	143
SPEEDY PNG	7139-0046	Cable pullers	143
SPEEDY PR GLASS	7139-0052	Cable pullers	143
SPEEDY REP	7139-0051	Cable pullers	143
SPEEDY RS	7139-0070	Cable pullers	143
SPEEDY SONDA 3/ 5-F	7139-0001	Cable pullers	140
SPEEDY SONDA 3/ 5-I	7139-0005	Cable pullers	140
SPEEDY SONDA 3/10-F	7139-0002	Cable pullers	140
SPEEDY SONDA 3/10-I	7139-0006	Cable pullers	140
SPEEDY SONDA 3/15-F	7139-0003	Cable pullers	140
SPEEDY SONDA 3/15-I	7139-0007	Cable pullers	140
SPEEDY SONDA 3/20-F	7139-0004	Cable pullers	140
SPEEDY SONDA 3/20-I	7139-0008	Cable pullers	140
SPEEDY SONDA 4/ 5-F	7139-0009	Cable pullers	140
SPEEDY SONDA 4/ 5-F-N	7139-0013	Cable pullers	140
SPEEDY SONDA 4/ 5-I	7139-0017	Cable pullers	140
SPEEDY SONDA 4/ 5-I-N	7139-0021	Cable pullers	140
SPEEDY SONDA 4/10-F	7139-0010	Cable pullers	140

Product	Code	Category	Page
SPEEDY SONDA 4/10-F-N	7139-0014	Cable pullers	140
SPEEDY SONDA 4/10-I	7139-0018	Cable pullers	140
SPEEDY SONDA 4/10-I-N	7139-0022	Cable pullers	140
SPEEDY SONDA 4/15-F	7139-0015	Cable pullers	140
SPEEDY SONDA 4/15-F-N	7139-0011	Cable pullers	140
SPEEDY SONDA 4/15-I	7139-0019	Cable pullers	140
SPEEDY SONDA 4/15-I-N	7139-0023	Cable pullers	140
SPEEDY SONDA 4/20-F	7139-0012	Cable pullers	140
SPEEDY SONDA 4/20-F-N	7139-0016	Cable pullers	140
SPEEDY SONDA 4/20-I	7139-0020	Cable pullers	140
SPEEDY SONDA 4/20-I-N	7139-0024	Cable pullers	140
SPEEDY SONDA 4/25-F	7139-0059	Cable pullers	140
SPEEDY SONDA 4/25-F-N	7139-0065	Cable pullers	140
SPEEDY SONDA 4/25-I	7139-0058	Cable pullers	140
SPEEDY SONDA 4/25-I-N	7139-0066	Cable pullers	140
SPEEDY STEEL 6/20	7139-0039	Cable pullers	142
SPEEDY STEEL 6/25	7139-0061	Cable pullers	142
SPEEDY STEEL 6/30	7139-0040	Cable pullers	142
SPEEDY STEEL 6/40	7139-0041	Cable pullers	142
SPEEDY STEEL 6/50	7139-0062	Cable pullers	142
SPEEDY STEEL 6/60	7139-0063	Cable pullers	142
SPEEDY TFC	7139-0043	Cable pullers	143
SPEEDY TFG	7139-0042	Cable pullers	143
SPEEDY TS	7139-0069	Cable pullers	143
SPEEDY WIRE GEL	900000-001	Lubricants	139
SPEEDY WIRE OIL	900000-003	Lubricants	139
SPEEDY WIRE SPRAY	SPEEDYWSPRAY	Lubricants	139
STOP ICE 10/12	STOPICE1012	Heating cables	210
STOP ICE 18/12	STOPICE1812	Heating cables	210
STOP ICE 2/12	STOPICE212	Heating cables	210
STOP ICE 5/12	STOPICES12	Heating cables	210
STOP ICE PLUS 2	STOPICEPLUS2	Heating cables	211
STOP ICE PLUS 5	STOPICEPLUS5	Heating cables	211
SUPER CLIK 0	SUPERCLIK0	Junctions	39
SUPER CLIK 1	SUPERCLIK1	Junctions	39
SUPER CLIK 2	SUPERCLIK2	Junctions	39
SUPER CLIK 3	SUPERCLIK3	Junctions	39
<b>T</b> TECHNO GEL GUM	TEGELGUM	Fillers	103
TECHNO GEL GUM 500	TEGELGUM500	Fillers	103
THERMO MINIMIX-MC	THERMOMIN-MC	Heat-shrink	125
THERMO MINIMIX-N	THERMOMIN-N	Heat-shrink	127
THVE 15/300-E	206772-000	Heat-shrink	184
THVE 15/50-E	120036-TEC	Heat-shrink	184
THVE 15/800-E	125336-TEC	Heat-shrink	184
THVE 15/A-RC	906848-000	Heat-shrink	182
THVE 15/B-RC	500365-000	Heat-shrink	182
THVE 15/C-RC	068756-000	Heat-shrink	182
THVE 20/150-E/U	123021-000	Heat-shrink	187
THVE 20/150-I/U	364179-000	Heat-shrink	187
THVE 20/185-E/U	365891-000	Heat-shrink	187
THVE 20/185-I/U	618430-000	Heat-shrink	187
THVE 20/240-E	255098-TEC	Heat-shrink	184

Product	Code	Category	Page
THVE 20/240-E-H5	THVE20/240-E-H5	Heat-shrink	184
THVE 20/240-I/U	521413-000	Heat-shrink	187
THVE 20/25-E	231047-TEC	Heat-shrink	184
THVE 20/25-E-H5	THVE20/25-E-H5	Heat-shrink	184
THVE 20/630-E	792760-000	Heat-shrink	184
THVE 20/630-E-H5	THVE20/630-E-H5	Heat-shrink	184
THVE 20/A-RC	507698-000	Heat-shrink	182
THVE 20/A-RC-H5	THVE20/A-RC-H5	Heat-shrink	182
THVE 20/B-RC	190360-000	Heat-shrink	182
THVE 20/B-RC-H5	THVE20/B-RC-H5	Heat-shrink	182
THVE 20/C-RC	485361-000	Heat-shrink	182
THVE 20/C-RC-H5	THVE20/C-RC-H5	Heat-shrink	182
THVE 30/185-E	120057-TEC	Heat-shrink	184
THVE 30/500-E	372083-000	Heat-shrink	184
THVE 30/95-E	900926-000	Heat-shrink	184
THVE 30/A-RC	454523-000	Heat-shrink	182
THVE 30/B-RC	308359-000	Heat-shrink	182
THVE 30/C-RC	651264-000	Heat-shrink	182
THVE 45/A-E	THVE45/A-E	Heat-shrink	196
THVE 45/A-I	THVE45/A-I	Heat-shrink	196
THVE 6/120-E	THVE6/120-E	Heat-shrink	184
THVE 6/400-E	164000-000	Heat-shrink	184
THVE 6/630-E	606630-TEC	Heat-shrink	184
THVE 6/A-RC	369608-000	Heat-shrink	182
THVE 6/B-RC	034189-000	Heat-shrink	182
THVE 6/C-RC	882065-000	Heat-shrink	182
THVE 60/A-E-SF	721100-000	Heat-shrink	196
THVE 60/A-E-SN	467930-000	Heat-shrink	196
THVE 60/A-I-SF	145145-000	Heat-shrink	196
THVE 60/A-I-SN	211099-000	Heat-shrink	196
THVE 60/B-E-SF	513817-000	Heat-shrink	196
THVE 60/B-E-SN	001110-TEC	Heat-shrink	196
THVE 60/B-I-SF	467917-000	Heat-shrink	196
THVE 60/B-I-SN	467921-000	Heat-shrink	196
THVE 60/C-E-SF	467925-000	Heat-shrink	196
THVE 60/C-E-SN	467931-000	Heat-shrink	196
THVE 60/C-I-SF	467918-000	Heat-shrink	196
THVE 60/C-I-SN	467922-000	Heat-shrink	196
THVE 60/D-E-SF	467943-000	Heat-shrink	196
THVE 60/D-E-SN	467944-000	Heat-shrink	196
THVE 60/D-I-SF	467940-000	Heat-shrink	196
THVE 60/D-I-SN	467942-000	Heat-shrink	196
THVI 20/A-3	507698-003	Heat-shrink	186
THVI 20/A-3-ARM	507698-004	Heat-shrink	186
THVI 20/A-ARM	507698-002	Heat-shrink	183
THVI 20/B-3	190360-003	Heat-shrink	186
THVI 20/B-3-ARM	190360-004	Heat-shrink	186
THVI 20/B-ARM	190360-002	Heat-shrink	183
THVI 20/C-3	485361-003	Heat-shrink	186
THVI 20/C-3-ARM	485361-004	Heat-shrink	186
THVI 20/C-ARM	485361-002	Heat-shrink	183
THVI 30/A-ARM	THVI30/A-ARM	Heat-shrink	183

Product	Code	Category	Page
THVI 30/A-3	507702-TTEC	Heat-shrink	186
THVI 30/A-3-ARM	THVI30/A-3-ARM	Heat-shrink	186
THVI 30/B-ARM	THVI30/B-ARM	Heat-shrink	183
THVI 30/B-3	507701-002	Heat-shrink	186
THVI 30/B-3-ARM	507701-001	Heat-shrink	186
THVI 30/C-ARM	THVI30/C-ARM	Heat-shrink	183
THVI 30/C-3	THVI30/C-3	Heat-shrink	186
THVI 30/C-3-ARM	THVI30/C-3-ARM	Heat-shrink	186
THVI 6/0-3	THVI6/0-3	Heat-shrink	186
THVI 6/0-3-ARM	THVI6/0-3-ARM	Heat-shrink	186
THVI 6/0-ARM	THVI6/0-ARM	Heat-shrink	183
THVI 6/A-3	THVI6/A-3	Heat-shrink	186
THVI 6/A-3-ARM	THVI6/A-3-ARM	Heat-shrink	186
THVI 6/A-ARM	THVI6/A-ARM	Heat-shrink	183
THVI 6/B-3	THVI6/B-3	Heat-shrink	186
THVI 6/B-3-ARM	THVI6/B-3-ARM	Heat-shrink	186
THVI 6/B-ARM	THVI6/B-ARM	Heat-shrink	183
THVI 6/C-3	THVI6/C-3	Heat-shrink	186
THVI 6/C-3-ARM	THVI6/C-3-ARM	Heat-shrink	186
THVI 6/C-ARM	THVI6/C-ARM	Heat-shrink	183
THVO 20/240-3	255101-TEC	Heat-shrink	186
THVO 20/240-3-ARM	255102-TEC	Heat-shrink	186
THVO 20/240-ARM	255100-TEC	Heat-shrink	185
THVO 20/25-3	231050-TEC	Heat-shrink	186
THVO 20/25-3-ARM	231051-TEC	Heat-shrink	186
THVO 20/25-ARM	231049-TEC	Heat-shrink	185
THVO 20/630-3	792763-000	Heat-shrink	186
THVO 20/630-3-ARM	792764-000	Heat-shrink	186
THVO 20/630-ARM	792762-000	Heat-shrink	185
THVO 30/95-3	231054-TEC	Heat-shrink	186
THVO 30/95-3-ARM	THVO30/95-3-ARM	Heat-shrink	186
THVO 30/95-ARM	THVO30/95-ARM	Heat-shrink	185
THVO 30/185-3	THVO30/185-3	Heat-shrink	186
THVO 30/185-3-ARM	THVO30/185-3-ARM	Heat-shrink	186
THVO 30/185-ARM	THVO30/185-ARM	Heat-shrink	185
THVO 30/240-3	THVO30/240-3	Heat-shrink	186
THVO 30/240-3-ARM	THVO30/240-3-ARM	Heat-shrink	186
THVO 30/500-ARM	THVO30/500-ARM	Heat-shrink	185
THVO 6/120-3	THVO6/120-3	Heat-shrink	186
THVO 6/120-3-ARM	THVO6/120-3-ARM	Heat-shrink	186
THVO 6/120-ARM	THVO6/120-ARM	Heat-shrink	185
THVO 6/35-3	THVO6/35-3	Heat-shrink	186
THVO 6/35-3-ARM	THVO6/35-3-ARM	Heat-shrink	186
THVO 6/400-3	THVO6/400-3	Heat-shrink	186
THVO 6/400-3-ARM	THVO6/400-3-ARM	Heat-shrink	186
THVO 6/400-ARM	THVO6/400-ARM	Heat-shrink	185
THVO 6/500-3	THVO6/500-3	Heat-shrink	186
THVO 6/500-3-ARM	THVO6/500-3-ARM	Heat-shrink	186
THVO 6/630-ARM	THVO6/630-ARM	Heat-shrink	185
THVO 6/70-ARM	THVO6/70-ARM	Heat-shrink	185
THVP 20/240-E/U-N1	145110-000	Heat-shrink	187
THVP 20/240-I/U	252214-000	Heat-shrink	187

Product	Code	Category	Page
TLV 0116-500	181198-000	Terminations	85
TLV 0150-500	181198-002	Terminations	85
TLV 0216	946613-000	Junctions	85
TLV 0216-500	181198-001	Terminations	85
TLV 0216-AF	106391-000	Junctions	85
TLV 0250	101526-000	Junctions	85
TLV 0250-500	181198-003	Terminations	85
TLV 0250-AF	024865-000	Junctions	85
TLV 0316	496973-000	Junctions	85
TLV 0316-500	816659-000	Terminations	85
TLV 0316-AF	178316-000	Junctions	85
TLV 0350	786134-000	Junctions	85
TLV 0350-AF	179335-000	Junctions	85
TLV 0416	288775-000	Junctions	85
TLV 0416-AF	121775-000	Junctions	85
TLV 0450	786200-000	Junctions	85
TLV 0450-AF	868777-000	Junctions	85
TLV 2150-500	179925-000	Terminations	85
TLV 2300-500	181198-005	Terminations	85
TLV 3150	786220-000	Junctions	85
TLV 3150-500	181198-004	Terminations	85
TLV 3150-AF	181196-000	Junctions	85
TLV 3300	208159-000	Junctions	85
TLV 3300-500	909765-000	Terminations	85
TLV 3300-AF	181097-000	Junctions	85
TLV 4150	597107-000	Junctions	85
TLV 4150-AF	223409-000	Junctions	85
TLV 4300	063097-000	Junctions	85
TLV 4300-AF	803719-000	Junctions	85
TLV 4500-AF	915556-000	Junctions	85

Product	Code	Category	Page
TLV-0350-500	828617-000	Terminations	85
<b>W</b> WARM UP 1	WARM-UP1	Heating cables	239
WARM UP 2	WARM-UP2	Heating cables	239
WATT	WATT	Junctions	16
WATT MP	WATT-MP	Junctions	16
WATT P15	WATTP15	Junctions	16
WATT + 1.5	WATT+1.5	Junctions	17
WATT + 2.5	WATT+2.5	Junctions	17
WONDER BOX 65	WONDERBOX65	KIT IP68	113
WONDER BOX 80	WONDERBOX80	KIT IP68	113
WONDER FLUID 210	WONDER-F210	Insulating fillers	100
WONDER FLUID 280	WONDER-F280	Insulating fillers	100
WONDER GEL	WONDER	Insulating fillers	98
WONDER GEL INVISIBLE	WONDER-INV	Insulating fillers	98
WONDER JOINT L10	WONDERJL10	Junctions	69
WONDER JOINT L25	WONDERJL25	Junctions	69
WONDER JOINT L4 (2 pc)	WONDERJL4	Junctions	69
WONDER JOINT SP L25	WONDERJSPL25	Junctions	72
WONDER JOINT SP L6	WONDERJSPL6	Junctions	72
WONDER JOINT SP Y16	WONDERJSPY16	Junctions	72
WONDER JOINT SP Y6	WONDERJSPY6	Junctions	72
WONDER JOINT Y25	WONDERJY25	Junctions	69
WONDER JOINT Y6	WONDERJY6	Junctions	69
WPCP-IV-4x17	WPCPIV-4x17	Heat-shrink	128
WPCP-IV-4x24	WPCPIV-4x24	Heat-shrink	128
WPCP-IV-6x17	WPCPIV-6x17	Heat-shrink	128
WPCP-IV-6x24	WPCPIV-6x24	Heat-shrink	128
WPCT-17x100-RL	WPCT17x100-RL	Heat-shrink	128
WPCT-24x100-RL	WPCT24x100-RL	Heat-shrink	128



"Information given here, including photos and drawings, are only intended as a general description. Raytech is not responsible for its accuracy, completeness and possible utilisation for working purposes. Raytech may only be held responsible for the product included in standard sales terms and conditions and declines any possible liabilities for direct or indirect accidents and/or damages produced by wrong and inappropriate use. Each user must decide the best way to use it".



**Ray  
tech**

**RAYTECH S.r.l.**

Via Enrico Fermi, 11/13/17  
Settimo Milanese (MILANO) - ITALY  
Tel.: +39 02 33500147

**raytech.it**