

# GEL CONNECTION

KLEINE WATERDICHTE ACCESSOIRES VOOR GROTE INSTALLATIES

**IPX8**  
OFFICIALLY  
TESTED | **IMQ**



**Ray  
tech**<sup>®</sup>

CABLE ACCESSORIES COMPANY



# Ray Tech®

CABLE ACCESSORIES COMPANY

## Revolution

pag. 4

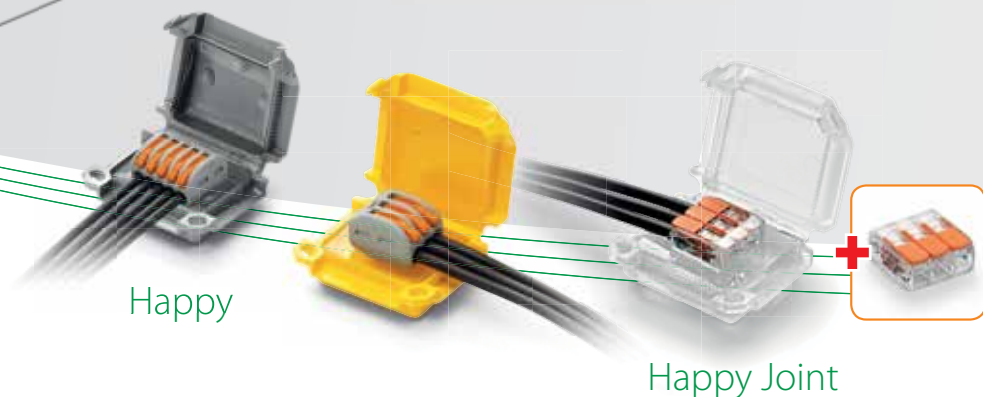

Happy

Happy Joint

## Classic

Gel Box Line

pag. 8



Isaac

Pascal

Pascal M2,5

Kit met schroefklemmen

Watt

Watt +

Kit met steek- en schroefklemmen

Joule

Kelvin

Kelvin +

Kit met steek- en schroefklemmen

Kelvin M4

Kit met schroefklemmen

**IPX8**  
OFFICIALLY  
TESTED

**IMQ**

# GEL CONNECTION

KLEINE WATERDICHTE ACCESSOIRES VOOR GROTE INSTALLATIES

**DE KRACHT VAN EENVOUD**, het grootste gamma aan vooraf gevulde accessoires om elektrische aansluitingen te beschermen, te beveiligen en te sluiten. Gebruiksklaar en geen houdbaarheidsdatum.

Ze bieden een maximale veelzijdigheid door een grote variatie aan afmetingen zodat ze elke installatie aankunnen met eenvoud en comfort. Geschikt voor verschillende types connectoren, van traditionele lusterklemmen tot de laatste innovatieve extra platte modellen.

Ze vertegenwoordigen het meest veelzijdige, gebruiksmakelijke en betrouwbare systeem voor connectoren die ontworpen zijn, zowel voor binnen- als buitenhuis.

## Classic

Gel Cover Line

pag. 12

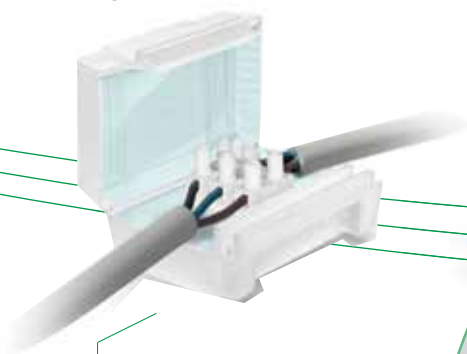

OHM & BAR



Mammut gel cover

## Special Kit

pag. 14



Nano Joint

Kit met steekklemmen en schroefklem



Nano For

Kit met steek- en schroefklemmen



Nano Mam

Kit met schroefklemmen

Bravo

Kit met steekklemmen en schroefklem



# Happy

Revolutionaire mini accessoires met 3 ingangen, vooraf met gel gevuld, waterdicht (IPX8).

Gel: UL 94-HB

Bedrijfstemperatuur 90°

Installatietemperatuur: -40°C / +50°C

Voor onderwaterstaand gebruik

Voor ondergronds gebruik

IPX8 OFFICIALLY TESTED | IMQ

Ontwikkeld in 3 dimensies om de meest gebruikte klemmen snel te isoleren en waterdicht te maken. De extreme flexibiliteit van het gamma wordt gegarandeerd door de 3 ingangen die de mogelijkheid geven voor een triple configuratie en behuizing voor een groot gamma van klemmen

- Gebruiksklaar, snel en heropenbaar!
- Voor stijve of soepele kabels tot 4 mm<sup>2</sup>
- Vooraf gevuld met gel, niet-giftig en geen houdbaarheidsdatum
- Klein, compact en transparant
- Halogeenvrij
- UV resistent

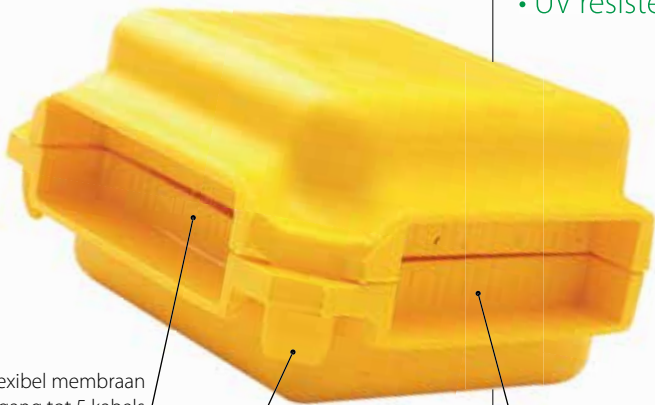

Flexibel membraan ingang tot 5 kabels

Veiligheidsafdichting

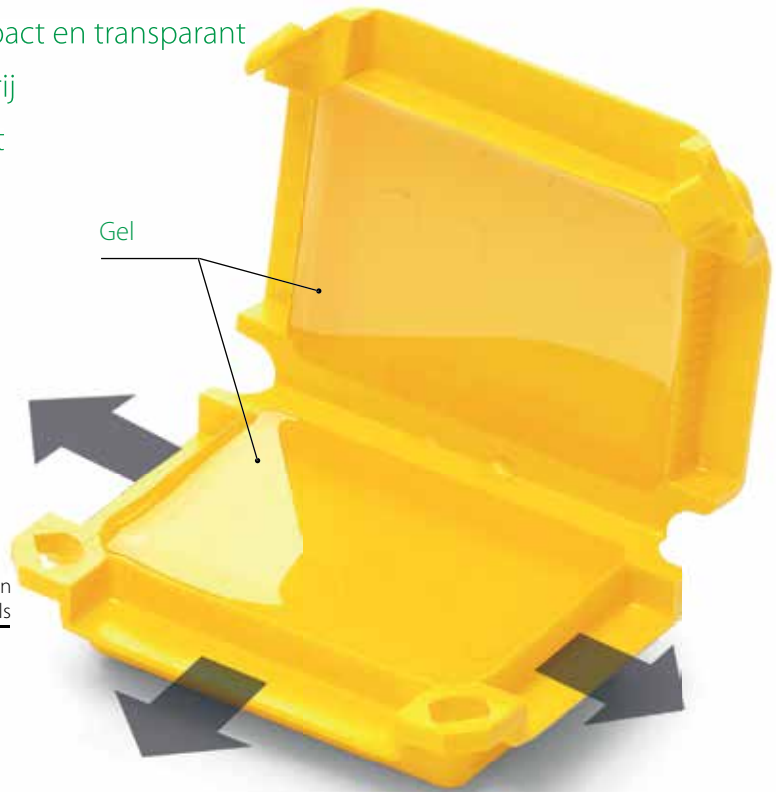

Gel

Flexibel membraan ingang tot 3 kabels

Voorbeelden van configuratie

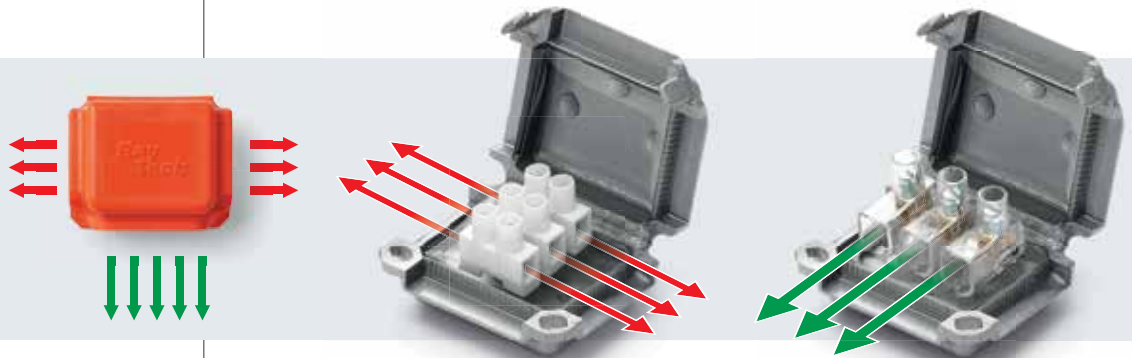



# Happy 0

Product	Omschrijving	Verpakking	A x B x C (mm)
Happy 0	x 4 stuks	Blister	41 x 28 x 19



IDEAAL VOOR (of iets dergelijks):



# Happy 1

Product	Omschrijving	Verpakking	A x B x C (mm)
Happy 1	x 2 stuks	Blister	45 x 37 x 24



IDEAAL VOOR (of iets dergelijks):

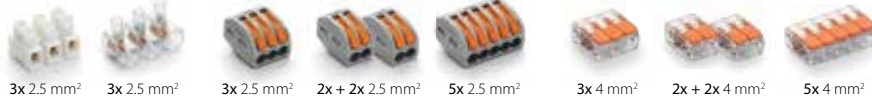

# Happy 2

Product	Omschrijving	Verpakking	A x B x C (mm)
Happy 1	x 1 stuk	Blister	53 x 39 x 24



IDEAAL VOOR (of iets dergelijks):

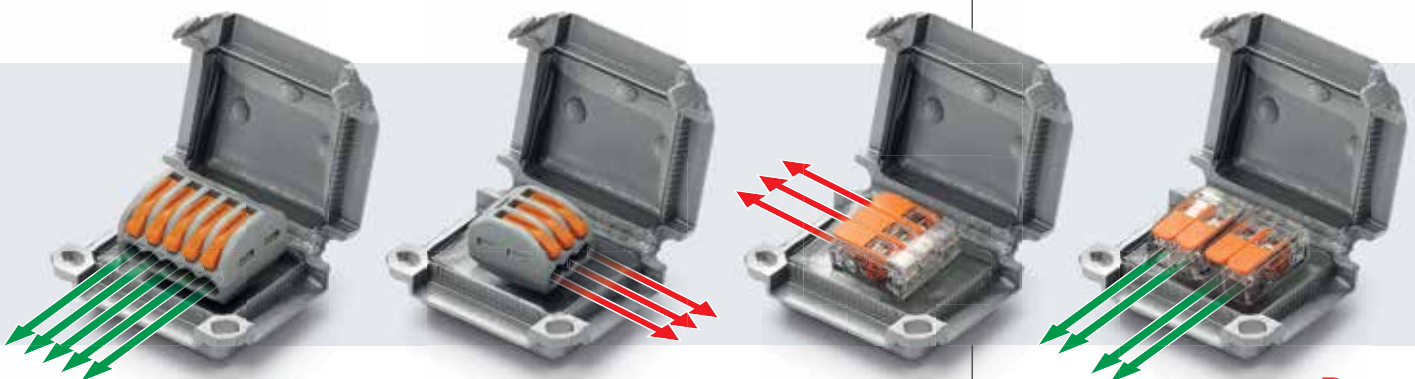
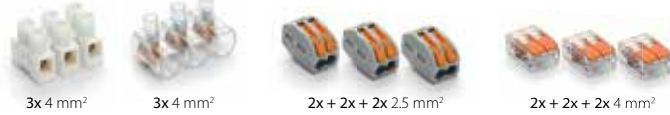



**Elektrische prestaties:**  
CEI EN 50393: 2006  
waar van toepassing

**Gel:** UL 94-HB

**Bedrijfstemperatuur:**

**Installatietemperatuur:**   
-40°C / +50°C

Voor onderwaterstaand gebruik

Voor ondergronds gebruik

**IPX8**  
OFFICIALLY TESTED **IMQ**

# Happy Joint

Revolutionaire mini accessoires met 3 ingangen, vooraf met gel gevuld, waterdicht. (IP X8)  
Met klemmen inbegrepen in de kit.

- Gebruiksklaar, snel en heropenbaar!
- Klein, compact en transparant
- Geen gereedschap nodig
- Vooraf gevuld met gel, niet-giftig en zonder houdbaarheidsdatum
- Kunnen direct in gebruik genomen worden
- Voor doorvoer of aansluiting met aftakking
- Voor stijve of soepele kabels tot 4 mm<sup>2</sup>
- Tot 5 aansluitingen op dezelfde fase of tot 2 aansluitingen op 2 of 3 fases
- Halogenvrij
- UV resistent

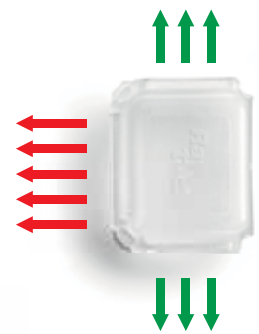

*De nieuwste generatie WAGO aansluitklemmen inbegrepen.*



## Happy Joint 3

Product	Afmetingen en kabelssectie (Max N° x mm <sup>2</sup> )		Combinatie	Verpakking	A x B x C (mm)
Happy Joint 3	3 x 1 - 4		2 rechte / 1 afgetakte	4 stuks in Blister	41 x 28 x 19



Met klem inbegrepen voor elke Happy



## Happy Joint 4

Product	Afmetingen en kabelssectie (Max N° x mm <sup>2</sup> )		Combinatie	Verpakking	A x B x C (mm)
Happy Joint 4	4 x 1 - 4		2 rechte / in/out	2 stuks in Blister	45 x 37 x 24



Met 2 klemmen inbegrepen voor elke Happy



## Happy Joint 5

Product	Afmetingen en kabelssectie (Max N° x mm <sup>2</sup> )		Combinatie	Verpakking	A x B x C (mm)
Happy Joint 5	5 x 1 - 4		2 rechte / 3 afgetakte	2 stuks in Blister	45 x 37 x 24



Met klem inbegrepen voor elke Happy



## Happy Joint 6

Product	Afmetingen en kabelssectie (Max N° x mm <sup>2</sup> )		Combinatie	Verpakking	A x B x C (mm)
Happy Joint 6	6 x 1 - 4		3 rechte / in/out	1 stuk in Blister	53 x 39 x 24



Met 3 klemmen inbegrepen voor elke Happy



HAPPY JOINT 3

HAPPY JOINT 4

HAPPY JOINT 5

HAPPY JOINT 6



Gel: UL 94-HB 

Bedrijfstemperatuur  90°

Installatietemperatuur:  -40°C / +50°C

Voor onderwaterstaand gebruik 

Voor ondergronds gebruik 

**IPX8**  
OFFICIALLY  
TESTED | **IMQ**

**GEL BOX LINE een eenvoudige manier om buiten aansluitklemmen voor binnen te gebruiken**

# Gel Box Line

Van te voren met gel gevulde accessoires ter bescherming en de beveiliging van kleine elektrische aansluitingen

- Voor het ordenen van installaties in huis
- Voor civiele en industriële aansluitingen
- Ook voor gebruik onder water
- Niet-giftig en zonder vervaldatum
- Veelzijdig en klaar voor gebruik
- Toepasbaar op de meest voorkomende connectoren







**JOULE**



**ISAAC**



**KELVIN**

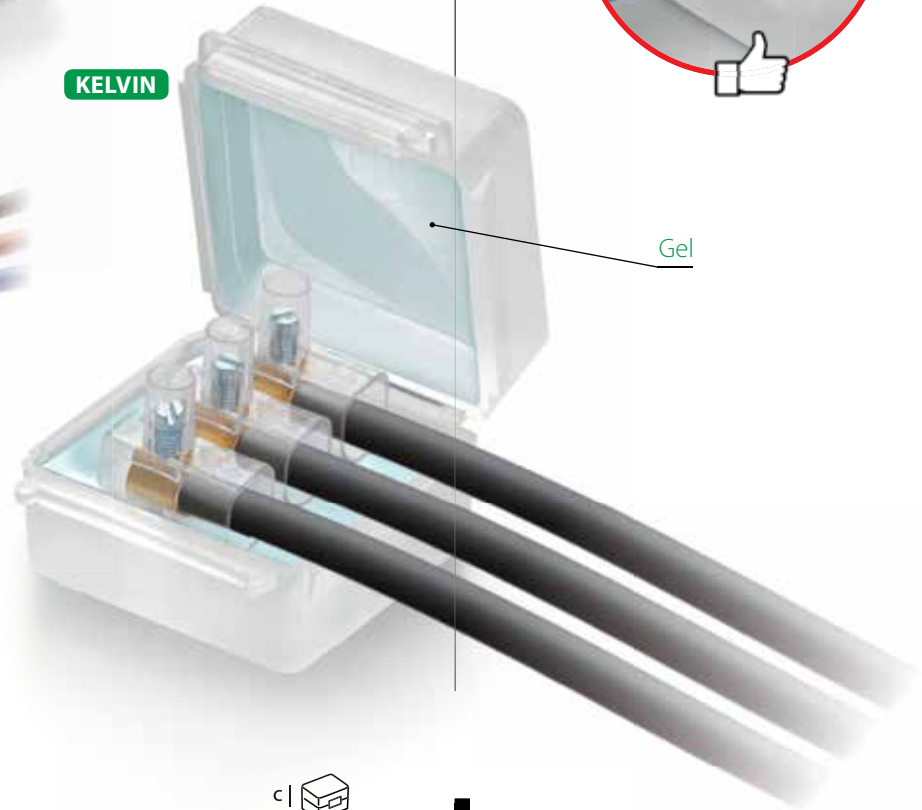

**PASCAL**



Gel

## Isaac



Product	Omschrijving	Verpakking	A x B x C (mm)
Isaac 4	x 4 stuks	B blister	30 x 27 x 23
Isaac 4 P30	x 30 stuks	Doos	
Isaac 4 MP *	x 50 stuks	Multipack	

IDEAAL VOOR (of iets dergelijks):



2x 2.5 mm<sup>2</sup>    2x 2.5 mm<sup>2</sup>    3x 2.5 mm<sup>2</sup>    2x 4 mm<sup>2</sup>    3x 4 mm<sup>2</sup>

\* Ook verkrijgbaar in vlamvertragende versie in de kleuren: geel, oranje, blauw of zwart.



## Pascal



Product	Omschrijving	Verpakking	A x B x C (mm)
Pascal 6	x 2 stuks	B blister	36 x 37 x 26
Pascal 6 P15	x 15 stuks	Doos	
Pascal 6 MP *	x 25 stuks	Multipack	

IDEAAL VOOR (of iets dergelijks):



2x 4 mm<sup>2</sup>    3x 4 mm<sup>2</sup>    3x 1.5 mm<sup>2</sup>    2x + 2x 2.5 mm<sup>2</sup>    5x 2.5 mm<sup>2</sup>

\* Ook verkrijgbaar in vlamvertragende versie in de kleuren: geel, oranje, blauw of zwart.





### Watt



Product	Omschrijving	Verpakking	A x B x C (mm)
Watt	x 2 stuks	Blister	30 x 42 x 26
Watt P15	x 15 stuks	Doos	
Watt MP *	x 25 stuks	Multipack	

IDEAAL VOOR (of iets dergelijks):



\* Ook verkrijgbaar in vlamvertragende versie in de kleuren: geel, oranje, blauw of zwart.



### Joule

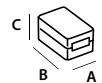

Product	Omschrijving	Verpakking	A x B x C (mm)
Joule	x 1 stuk	Blister	33 x 52 x 26
Joule MP *	x 20 stuks	Multipack	

IDEAAL VOOR (of iets dergelijks):



\* Ook verkrijgbaar in vlamvertragende versie in de kleuren: geel, oranje, blauw of zwart.



### Kelvin

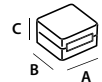

Product	Omschrijving	Verpakking	A x B x C (mm)
Kelvin	x 1 stuk	Blister	52 x 53 x 29
Kelvin P9	x 9 stuks	Doos	
Kelvin MP *	x 20 stuks	Multipack	

IDEAAL VOOR (of iets dergelijks):



\* Ook verkrijgbaar in vlamvertragende versie in de kleuren: geel, oranje, blauw of zwart.





# Gel Box Line Kit

Compleet met connectoren



## Pascal M2,5



Product	Omschrijving	Verpakking	A x B x C (mm)
Pascal M2,5	12 stuks + 36 schroefconnectoren terminals van 2.5 mm <sup>2</sup>	Doos	36 x 37 x 26



## Kelvin M4



Product	Omschrijving	Verpakking	A x B x C (mm)
Kelvin M4	6 stuks + 24 schroefconnectoren terminals van 4 mm <sup>2</sup>	Doos	52 x 53 x 29

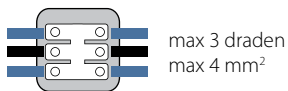

## Watt +



Product	Omschrijving	Verpakking	A x B x C (mm)
Watt + 1.5	10 stuks + 30 schroefconnectoren terminals van 1.5 mm <sup>2</sup>	Doos	30 x 42 x 26
Watt + 2.5	10 stuks + 30 schroefconnectoren terminals van 2.5 mm <sup>2</sup>	Doos	

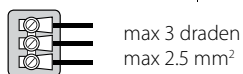

## Kelvin +



Product	Omschrijving	Verpakking	A x B x C (mm)
Kelvin + 4	10 stuks + 30 schroefconnectoren terminals van 4 mm <sup>2</sup>	Doos	52 x 53 x 29
Kelvin + 6	10 stuks + 30 schroefconnectoren terminals van 6 mm <sup>2</sup>	Doos	
Kelvin 6+4	6 stuks + 20 schroefconnectoren terminals van 4 mm <sup>2</sup>	Doos	
Kelvin 6+6	6 stuks + 20 schroefconnectoren terminals van 6 mm <sup>2</sup>	Doos	

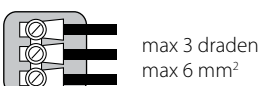



Elektrische prestaties: CEI EN 50393

Gel: UL 94-HB

Bedrijfstemperatuur 90°

Installatietemperatuur: -40°C / +50°C

**IPX8**  
OFFICIALLY  
TESTED | **IMQ**

# Gel Cover Line

Al met gel gevuld accessoire voor rechte aansluitingen voor de bescherming, beveiliging en afdekking van elektrische aansluitingen met connectoren.

- Voor kabels 3 x 1 a 6 mm<sup>2</sup>, of met 3 geïsoleerde draden
- Voor civiele en industriële aansluitingen
- Voor het ordenen van huishoudelijke installaties
- Ook voor gebruik onder water
- Niet-giftig en zonder houdbaarheidsdatum
- Gereed voor gebruik

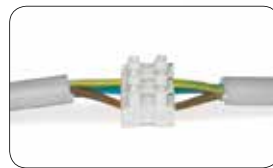

# OHM & BAR

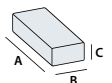

Product	Te plaatsen type connectoren	Aantal per verpakking	Soort verpakking	Afmeting A x B x C (mm)
OHM	2 van 4 mm <sup>2</sup>	1	Blister	61 x 35 x 28
OHMp11		11	Doos	
BAR	3 van 4 mm <sup>2</sup> / 6 mm <sup>2</sup>	1	Blister	63 x 41 x 28
BARp9		9	Doos	



# Mammut Gel Cover

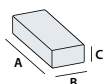

Product	Te plaatsen type connectoren	Aantal per verpakking	Soort verpakking	Afmeting A x B x C (mm)
Gel Cover 4	2 van 4 mm <sup>2</sup>	1	Blister	61 x 35 x 28
Mammut Gel Cover		6	Doos	
Gel Cover 6	3 van 4 mm <sup>2</sup> / 6 mm <sup>2</sup>	1	Blister	63 x 41 x 28
Mammut Gel Cover 6		8	Doos	

Vlamremmend. CEI 20-35 • IEC 60332-1 • HD405-1 (waar van toepassing). **Mengbare omhulling:** UL 94-V2

installatie voorbeelden

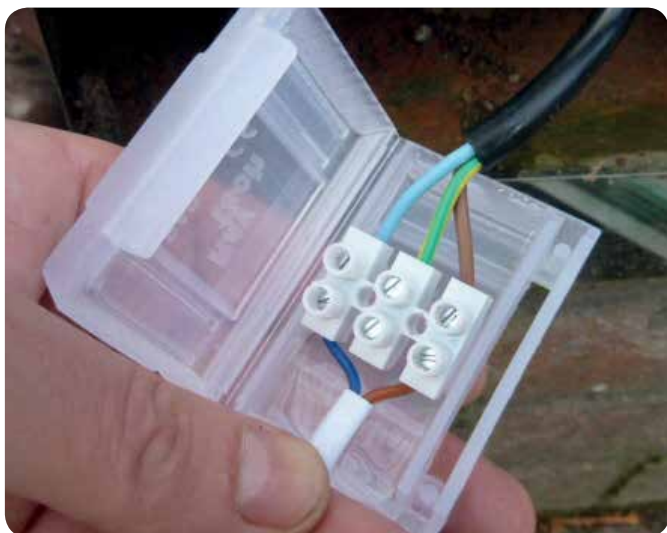

**Elektrische prestaties:**

CEI EN 50393: 2006  
waar van toepassing

Gel: UL 94-HB 

Bedrijfstemperatuur 

Installatietemperatuur:   
-40°C / +50°C

Voor onderwaterstaand  
gebruik 

Voor ondergronds  
gebruik 

**IPX8**  
OFFICIALLY  
TESTED **IMQ**

# Nano Joint

Vooraf met gel gevulde accessoires met geïntegreerde steekklemmen om elektrische aansluitingen te sluiten, te beschermen en te beveiligen

- Gebruiksklaar, snel en heropenbaar!
- Ideaal voor buiten en ondergrondse installaties, bescherming tegen volledige onderdompeling
- Zonder gereedschap
- Direct aansluitbaar
- Voor doorvoer of aansluiting met aftakking
- Voor stijve of soepele geïsoleerde kabels van 1 tot 4 mm<sup>2</sup>
- Voor eenpolige, tweepolige tot driepolige aansluitingen
- Tot vijf geleiders van een fase of tot twee geleiders op twee of drie fasen
- Klein, compact en bestendig
- Geen vervaldatum
- Halogeenvrij
- UV resistent



**NANO JOINT 3**

**NANO JOINT 5**

**NANO JOINT 6**

*De nieuwste  
generatie WAGO  
aansluitklemmen  
inbegrepen.*



## Nano 3

Product	Afmetingen en kabelssectie (Max N° x mm <sup>2</sup> )		Combinatie	Verpakking	A x B x C (mm)
Nano 3	3 x 1 - 4		2 rechte / 1 afgetakte	4 stuks in Blister	30 x 27 x 23



Met klem inbegrepen  
voor elke Nano Joint



## Nano 5

Product	Afmetingen en kabelssectie (Max N° x mm <sup>2</sup> )		Combinatie	Verpakking	A x B x C (mm)
Nano 5	5 x 1 - 4		2 rechte / 3 afgetakte	2 stuks in Blister	30 x 42 x 26



Met klem inbegrepen  
voor elke Nano Joint



## Nano 6

Product	Afmetingen en kabelssectie (Max N° x mm <sup>2</sup> )		Combinatie	Verpakking	A x B x C (mm)
Nano 6	6 x 1 - 4		3 rechte / In/Out	1 stuk in Blister	33 x 52 x 26





Met 3 klemmen inbegrepen  
voor elke Nano Joint







**Elektrische prestaties:**  
CEI EN 50393: 2006  
waar van toepassing

**Gel:** UL 94-HB 

Bedrijfstemperatuur 

Installatietemperatuur:   
-40°C / +50°C

Voor onderwaterstaand  
gebruik 

Voor ondergronds  
gebruik 

**IPX8**  
OFFICIALLY  
TESTED | **IMQ**

# Nano Mam - For

Vooraf met gel gevulde accessoires met geïntegreerde steekklemmen om elektrische aansluitingen te sluiten, te beschermen en te beveiligen

- Gebruiksklaar, snel en heropenbaar!
- Ideaal voor buiten en ondergrondse installaties, bescherming tegen volledige onderdompeling
- Direct aansluitbaar
- Voor doorvoer of aansluiting met aftakking
- Voor stijve of soepele geïsoleerde kabels van 1 tot 4 mm<sup>2</sup>
- Voor eenpolige, tweepolige tot driepolige aansluitingen
- Klein, compact en bestendig
- Geen vervaldatum
- Halogeenvrij
- UV resistent







## Nano Mam 2,5



Product	Afmetingen en kabelssectie (Max N° x mm <sup>2</sup> )	Combinatie	Verpakking	A x B x C (mm)
Nano Mam 2,5	3 x 1 - 2,5	3 rechte	2 stuks in Blister	36 x 37 x 26



Met klem inbegrepen voor elke Nano Mam

## Nano Mam 4



Product	Afmetingen en kabelssectie (Max N° x mm <sup>2</sup> )	Combinatie	Verpakking	A x B x C (mm)
Nano Mam 4	3 x 1,5 - 4	3 rechte	1 stuk in Blister	52 x 53 x 29

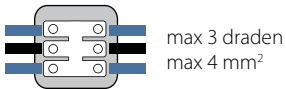

Met klem inbegrepen voor elke Nano Mam

## Nano For 2,5



Product	Afmetingen en kabelssectie (Max N° x mm <sup>2</sup> )	Combinatie	Verpakking	A x B x C (mm)
Nano For 2,5	3 x 1 - 2,5	3 verbindingen / In/Out	1 stuk in Blister	33 x 52 x 26

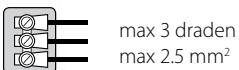

Met klem inbegrepen voor elke Nano For

## Nano For 4



Product	Afmetingen en kabelssectie (Max N° x mm <sup>2</sup> )	Combinatie	Verpakking	A x B x C (mm)
Nano For 4	3 x 1 - 4	3 verbindingen / In/Out	1 stuk in Blister	52 x 53 x 29



Met klem inbegrepen voor elke Nano For



**Elektrische prestaties:**

CEI EN 50393: 2006  
waar van toepassing

Gel: UL 94-HB 

Bedrijfsspanning: 0,6 / 1kV

Bedrijfstemperatuur  90°

Installatietemperatuur:  -40°C / +50°C

Voor onderwaterstaand gebruik 

Voor ondergronds gebruik 

**IPX8**  
OFFICIALLY  
TESTED | **IMQ**



# Bravo

De eerste "Gel-Box" met geïntegreerde connectoren!

- Gebruiksklaar, snel en heropenbaar!
- Zelfsluitende behuizing
- Voor stijve of soepele geïsoleerde kabels van 1 tot 6 mm<sup>2</sup>
- Direct aansluitbaar
- Voor doorvoer of aansluiting met aftakking
- Voor eenpolige tot driepolige aansluitingen
- Klein, compact en transparant
- Geen vervaldatum
- Halogeenvrij
- UV resistent

**BRAVO 3-6**

**BRAVO 1-6**



## Bravo 1-6

Product	Afmetingen en draadsectie		Verpakking	A x B x C (mm)
	Doorvoer (N° x mm <sup>2</sup> )	Aftakking (N° x mm <sup>2</sup> )		
Bravo 1-6	1 x 1 - 6	1 x 1 - 6	1 stuk in Blister	50 x 29 x 22

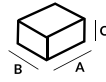

## Bravo 3-6

Product	Afmetingen en draadsectie		Verpakking	A x B x C (mm)
	Doorvoer (N° x mm <sup>2</sup> )	Aftakking (N° x mm <sup>2</sup> )		
Bravo 3-6	2 x 1 - 6 3 x 1 - 6	2 x 1 - 6 3 x 1 - 6	1 stuk in Blister	53 x 49 x 22

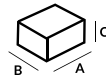

### 1. Aansluiten



RECHT OP RECHT

### 2. Bevestigen

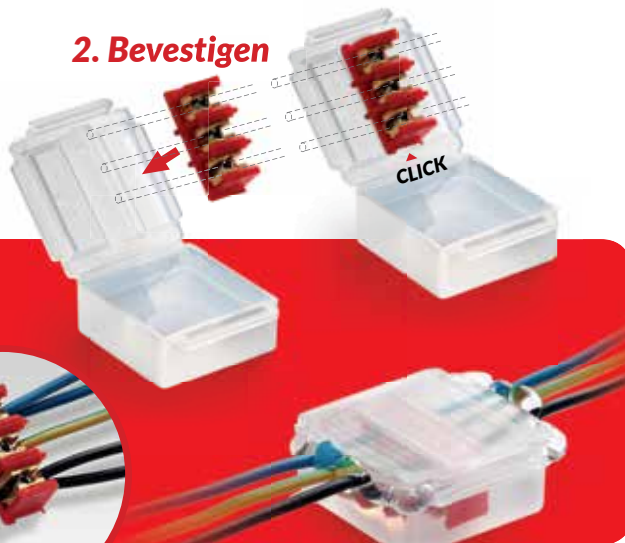

AFTAKKING

### 3. Sluiten

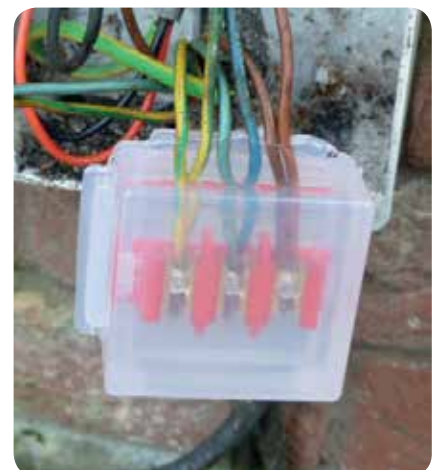



# Kies het geschikte accessoire voor uw

**Gel Connection**  
**Accessoires geschikt voor onderwater gebruik**

**IPX8**  
OFFICIALLY TESTED

**IMQ**

Gel: UL 94-HB  us

Bedrijfstemperatuur  90°

Installatietemperatuur:  -40°C / +50°C

Voor onderwaterstaand gebruik 

Voor ondergronds gebruik 

**Ray  
Tech**

GEL CONNECTION	SCHROEFKLEMMEN		STEEKKLEMMEN
	2x	3x	3x
<b>Revolution</b>	 <b>HAPPY 0</b> 41 x 28 x 19 mm	 2,5 mm <sup>2</sup>	 3x
	 <b>HAPPY 1</b> 45 x 37 x 24 mm	 2,5 mm <sup>2</sup>	 2,5 mm <sup>2</sup>
	 <b>HAPPY 2</b> 53 x 39 x 24 mm		 4 mm <sup>2</sup>
<b>Classic Gel Box Line</b>	 <b>ISAAC</b> 30 x 27 x 23 mm	 2,5 mm <sup>2</sup>	
	 <b>PASCAL</b> 36 x 37 x 26 mm	 4 mm <sup>2</sup>	 4 mm <sup>2</sup>
	 <b>WATT</b> 30 x 42 x 26 mm		 2,5 mm <sup>2</sup>
	 <b>JOULE</b> 33 x 52 x 26 mm		 4 mm <sup>2</sup>
	 <b>KELVIN</b> 52 x 53 x 29 mm		 4 mm <sup>2</sup>
			 6 mm <sup>2</sup>

# toepassing, te beginnen met de connector naar voorkeur

CONNECTOREN MET KLEP van eerste generatie (vb WAGO 222 of vergelijkbaar)			KLEMMEN MET PLATTE KLEP (vb WAGO 221 of vergelijkbaar)		
2x	3x	5x	2x	3x	5x
					
					
					
					
					
					
					
					





“De geleverde informatie, met inbegrip van de foto’s en tekeningen, dienen slechts als een algemene beschrijving te worden beschouwd. Raytech is niet verantwoordelijk voor de nauwkeurigheid, volledigheid en het gebruik hiervan voor operationele doeleinden. Raytech acht zich uitsluitend verantwoordelijk voor de producten die van de standaard verkoopsmethodes en verkoopvoorwaarden deel uit maken en wijst alle mogelijke verantwoordelijkheid af voor directe of indirecte ongevallen en/of schade veroorzaakt door een verkeerde en onjuiste toepassing. Elke gebruiker is verplicht zelf de beste gebruikswijze vaststellen.”

# GEL CONNECTION

KLEINE WATERDICHTE ACCESSOIRES VOOR GROTE INSTALLATIES

**IPX8**  
OFFICIALLY  
TESTED

**IMQ**

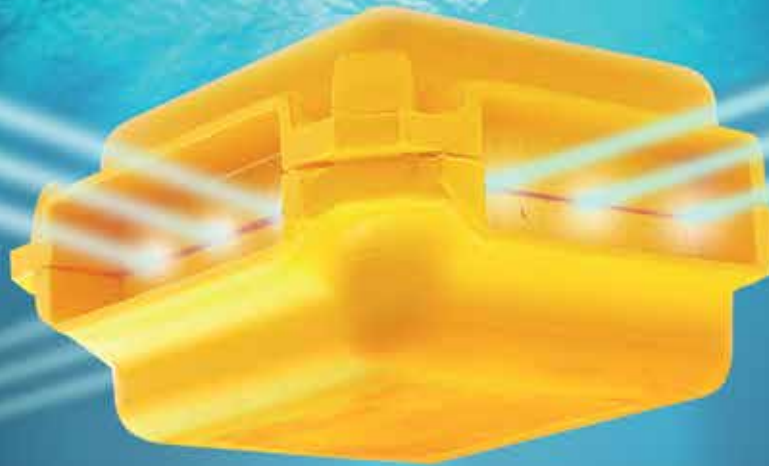

# Ray tech®

CABLE ACCESSORIES COMPANY



RAYTECH S.r.l.  
Via Enrico Fermi 11/13/17  
Settimo Milanese (MI)  
tel: +39 02 33500 147

[www.raytech.it](http://www.raytech.it)